

**THE
SECOND EDITION**



**ADAMTM
Resource
DIRECTORY**



**THE ADAM COMPUTER OWNER'S BIBLE...
EVERYTHING IN THE GALAXY FOR ADAM...& MORE!**

ADAM TM IS A REGISTERED TRADEMARK OF COLECO INDUSTRIES

© COPYRIGHT 1986

The ADAM RESOURCE

The publisher does not endorse any company or listing appearing in this directory, nor does it represent or warrant the performance or any other aspect of the companies, their products or services. Information was obtained from advertisements and vendors. All prices, etc., are subject to change without notice. Many of the listings include reference to trade names. Such trade names are used only for the purpose of identification.

All precautions have been made to avoid errors. However, the publisher does not assume and hereby disclaims any liability to any party for any loss or damage caused by errors or omissions, whether such errors or omissions result from negligence, accident or any other cause.



COMPILED

&

EDITED

BY

KEITH A BURROWS

WELCOME TO
THE SECOND
EDITION



Welcome to the **SECOND EDITION** of the **ADAM RESOURCE DIRECTORY**. I believe you'll find more resource information in this book for the ADAM than you will anywhere! I am told by sources that more than 900,000 ADAMS were made. Unfortunately, a large number of those are just sitting on shelves collecting dust. **WHY?** Simply because people do not know all the power ADAM has & what is available on the market today. **THAT'S THE REASON FOR THIS BOOK!** In the pages to follow, you will find enough info to keep your ADAM alive for a longgggg time! COLECO may have abandoned this machine & tried to kill it, but I'm glad to tell you that **ADAM LIVES ON!!!** So if you have an ADAM sitting around collecting dust. Get it out and start putting it to work for you!! Or if you already use yours, look through this book & find out how you can use it more!!!!

We have made a number of improvements since our first directory to better meet your needs as an ADAM user. Some of those include: *New Spiral Binding, 3-times the info, added pages, added sections, indexing titles on page edges for easy reference, two-color title pages, etc...*

All this comes together in a useful, practical, and attractive piece of literature that we hope you will refer to again and again throughout the year.

I wish to thank some very special people who were an inspiration to make such a book. First of all, my wife, Cheryl, who came up with the idea & put up with me while I compiled it over many months. Gary Woodruff, for his invaluable help in putting this thing together, my Father-in-law for his proof-reading skills. **AND OTHERS WHO WERE A HELP....** Al Roginsky, Lyle Marschand, as well as all the **ADAM COMPANIES** that cooperated in supplying us with the necessary info for this publication. Most of all I give thanks to the Lord above who meets and supplies our needs day in and day out. He's the one who enables us to do all things!...for He is our greatest resource in life! God Bless! & **Happy ADAMING !!!!** - Keith Burrows

INTRODUCING

Adam Resource Update Sheets

Due to the fact that things in the computer world are always in a state of change, THE ADAM RESOURCE offers to you Update Sheets periodically throughout the year. Corrections, additions, new software etc.. will be included so you can keep your directory up to date. YOU WILL NOT AUTOMATICALLY RECEIVE THEM. THIS SERVICE IS FREE TO ALL 2nd EDITION PURCHASERS, BUT YOU MUST DO THE FOLLOWING:

1. FILL-OUT the "FEEDBACK" SHEET IN THE BACK OF THIS DIRECTORY.
2. PREPARE 3- SELF-ADDRESSED-STAMPED ENVELOPES. (BUSINESS SIZE 4 1/8 x 9 1/2)
3. SEND THE ABOVE TO:
THE ADAM RESOURCE
UPDATE DEPARTMENT
BOX 90
SEELYVILLE, IN 47878

NOTE:
THERE ARE NO SET DATES FOR UPDATE SHEETS. THE ADAM RESOURCE RESERVES THE RIGHT TO PREPARE SHEETS WHEN ADEQUATE INFO HAS BEEN COLLECTED.

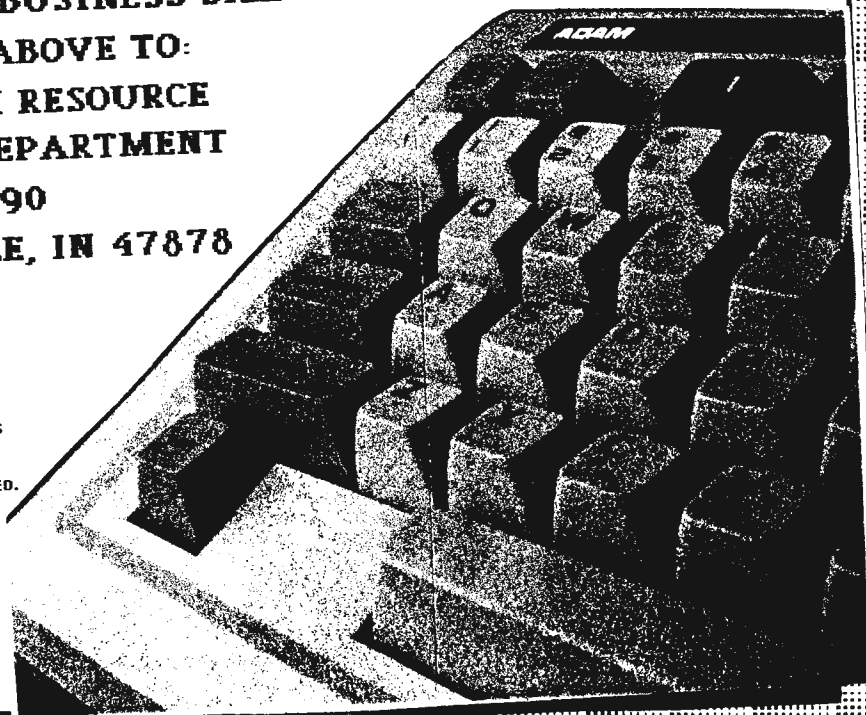

The ADAM Resource File
 VOLUME 1, NUMBER 1977

TABLE OF CONTENTS

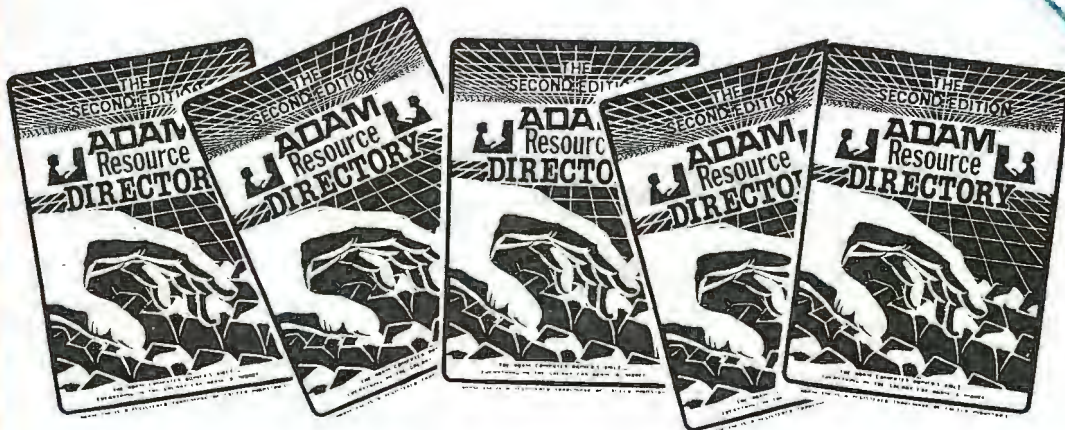

SOFTWARE SECTION.....	5
SOFTWARE BY CATAGORY.....	17
CP/M SOFTWARE INFO.....	20
PUBLIC DOMAIN SOFTWARE SOURCES.....	21
HARDWARE SECTION.....	22
PUBLICATION SECTION.....	28
ADAM BOOKS.....	29
ADAM PUBLICATIONS.....	32
GENERAL COMPUTER MAGAZINES.....	33
CP/M & Z-80 BOOKS.....	36
RETAILERS SECTION.....	37
COMPUTER SUPPLY RESOURCES.....	43
USER GROUP SECTION.....	45
ADAM USER SECTION.....	51
SERVICE INFORMATION.....	58
HONEYWELL SERVICE CENTERS.....	61
ONLINE SECTION.....	62
GENERAL TIP SECTION.....	68
ADAM HACKER SECTION.....	76
ADAM POKES & PEEKS.....	77
ADAM SYSTEM CALLS.....	79
ADAM/APPLE EQUIVALENTS.....	81
TEXT COLOR TABLE.....	82
HEX DECIMAL CONVERSION TABLE.....	82
SPRITE INORMATION.....	83
ADAM SHOPPER SECTION.....	86



The Software Section

You will find the following
in the ADAM
SOFTWARE SECTION:

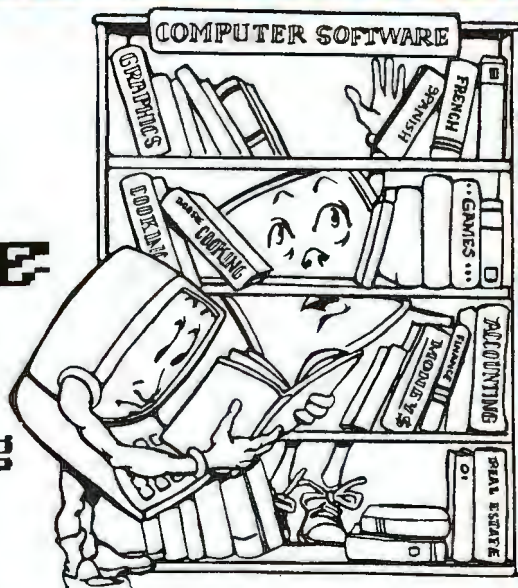

1. **MASTER SOFTWARE LISTING** - Approximately 400 pieces of ADAM software are listed including all the important info you need to know.
2. **ADAM SOFTWARE BY CATEGORY** - This area simply lists all the titles of ADAM software divided into categories for quick reference. After finding what you want, you can then look it up in the **MASTER LISTING**.
3. **ADAM CP/M SOFTWARE INFORMATION** - Information on sources for obtaining CP/M Software for the ADAM.
4. **ADAM PUBLIC DOMAIN SOFTWARE** - Info & suggestions on where to find Public Domain (Non-Copyrighted) software at little or no cost.

ATTENTION : COMMERCIAL SOFTWARE PRODUCERS
PLEASE KEEP THE ADAM RESOURCE INFORMED OF YOUR NEW SOFTWARE SO WE CAN UPDATE THIS LISTING. SEND US YOUR LATEST LISTS AS THEY BECOME AVAILABLE & WE WILL LIST THEM HERE.

THE ADAM RESOURCE DOES NOT IN ANY WAY RECOMMEND ALL OF THESE PROGRAMS SIMPLY SINCE THEY ARE INCLUDED IN THESE LISTINGS. THE USER MUST DO HIS OWN HOMEWORK IN PURCHASING THE RIGHT PROGRAM FOR HIS OR HER NEEDS. A GOOD WAY TO KEEP IN TOUCH IS TO SUBSCRIBE TO A MONTHLY OR BI-MONTHLY ADAM NEWSLETTER AS MANY OF THEM HAVE REVIEW SECTIONS FOR NEW SOFTWARE.



THIS IS OUR MASTER SOFTWARE LISTING. ON THE NEXT SEVERAL PAGES YOU WILL FIND SEVERAL HUNDRED ADAM PROGRAMS LISTED ALPHABETICALLY.

HERE IS THE FORMAT WE USED FOR EACH LISTING:

- PROGRAM NAME
- CATAGORY
- MANUFACTURER
- PRICE
- BRIEF DESCRIPTION

(Note: Prices quoted are average retail prices as of this printing. These may vary. Also, some ADAM companies make special offers from time to time. We placed all programs into catagories. Some software could be included in more than one catagory. In that case, we chose the most common catagory for that software. The "boxes" in front of each listing is for your convenience. Use them however you wish.



THE FOLLOWING ABBREVIATIONS HAVE BEEN USED IN THIS SECTION:

- | | |
|---------------------|-------------------------|
| D - DISK | ENT - ENTERTAINMENT |
| C - CARTRIDGE | UTI - UTILITY |
| T - DATAPACK (TAPE) | HOM - HOME APPLICATIONS |
| | GRA - GRAPHICS |
| MUS - MUSIC | CPM - CPM |
| FIN - FINANCES | |
| BUS - BUSINESS | |
| EDU - EDUCATIONAL | |

- [] 2010 ACTION - ENT-C - Coleco - \$19.00
No additional information available.
- [] 2010 TEXT ADVENTURE - ENT-T - Coleco - \$19.00
A full length text adventure. Complex and involving, with exceptional graphics and sound affects. Can be converted to disk via a copy service from NIAD for a \$4 fee.
- [] 32 BASIC PROGRAMS - ENT-T - Dilithium Press - \$24.95
Book included.
- [] ABC'S - EDU-DT - CME Software - \$14.95
\$9.95 to members. Interactive, ages 2-6.
- [] ACTIVISION DECATHALON - ENT-C - Activision - \$27.95
No additional information available.
- [] ADAM AGENDA - HOM-DT - U.S. Adam Network - \$8.00
No additional information available.
- [] ADAM CALC - BUS-T - Coleco - \$19.95
Colecos own, and probably the best spread sheet available at this time.
- [] ADAM DIAGNOSTIC - UTI-DT - Public Domain - \$5.00
Avaliable from NIAD for use with the 64K expander.
- [] ADAM FILER - BUS-T - Adam World Ent. - \$19.95
No additional information available.
- [] ADAM'S RIB - EDU-T - Tapeware Technology - \$32.95
No additional information available.
- [] ADAMBANNER - HOM-DT - Challenge Ware - \$7.00
Create banners and signs.
- [] ADAMLINK II - UTI-T - Coleco - \$9.00
Colecos replacement for Adamlink it allows for downloading across the telephone lines.
- [] ADAVENTURE PACK 1 - ENT-DT - Victory Software - \$9.95
3 text programs. Moon Base Alpha, Jack & The Beanstalk, and Computer Adventure.
- [] ADBASIC - EDU-DT - CME Software - \$19.95
A compliment to EasyBasic, available to members for \$12.95.
- [] ADVENTURE PACK 2 - ENT-DT - Victory Software - \$19.95
3 text programs. African Adventure, Hospital Adventure, and Bomb Threat.
- [] ADVENTURE PACK I - ENT-DT - Adamagic - \$37.00
12 text adventures and simulations.
- [] ADVENTURE PACK II - ENT-DT - Adamagic - \$37.00
11 text adventures and simulations.
- [] ADVENTURER - EDU-T - Data Backup - \$17.00
Word game that takes you and a friend on a trip to a beautiful island. Many exciting passages.
- [] ALPHABET ZOO - EDU-C - Spinnaker - \$23.00
No additional information available.

Software

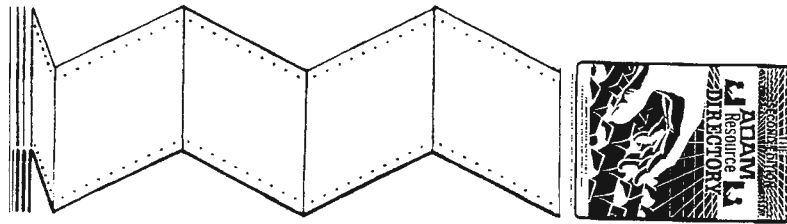

Software

- [] AMERICA AT WAR - EDU-T - A-ware Educational - \$12.00
No additional information available.
- [] ANALYSIS - BUS-DT - Kray Software - \$20.00
Listing only \$10.00. Line & bar graphs, and percentage analysis.
- [] ANTARCTIC ADVENTURE - ENT-C - Coleco - \$15.00
No additional information available.
- [] APPIAN WAY - ENT-T - Challenge Ware - \$19.95
Requires LOGO. Keep your chariot on the road to adventure!
- [] AQUATTACK - ENT-C - Interphase Tech. - \$17.95
Multiscreen action game.
- [] ARTISTS PAD - GRA-T - Nickelodeon Graphics - \$25.00
Converts the paddle control into a hi-res graphics pad.
- [] AUTOAID - UTI-DT - Future Vision - \$29.95
Enhances Smart Basic so the novice can concentrate on programming, not the mechanics of Basic.
- [] AWARDS & CERTS - MIS-DT - CME Software - \$19.95
Prints awards & certificates.
- [] ADDRESS BOOK & AUTODIALR - HOM-T - Coleco - \$34.95
Includes autodialer.
- [] ADDRESS FILE - BUS-T - Micro 2 - \$24.95
Address, and telephone information.
- [] ADDRESS LABELS - BUS-DT - Kray Software - \$17.00
Listing only \$7.00.
- [] ADVENTURE PACK - ENT-DT - INCO - \$16.95
No additional information available.
- [] BASIC PACK I - UTI-DT - Adamagic - \$37.00
10 programs and 5 subroutines for the Adam smartbasic programmer that wants to more fully utilize the sound and graphics capabilities of the Adam.
- [] BACKUP 3.0 - UTI-DT - MMSG - \$19.00
Copy utility with 40K/104K buffers, Tests memory, Formats disks, Image copies of even the short tapes, mixes formats, and Identifies bad blocks.
- [] BACKUP+ 3.0 - UTI-DT - MMSG - \$34.00
All of BACKUP 3.0's features plus Copying of individual blocks, Block status utility, File directories, Prints catalog directories, and Formats disks and inits tapes and disks while in the program.
- [] BASIC GAME LIBRARY - ENT-T - Davasan Software - \$39.95
Russian Roulette, Checkers, Golf, Poker, Computer Stories, Bowling, etc.
- [] BASIC MANAGER - UTI-DT - Practical Programs - \$29.95
Utility management program with approximately 16 separate functions, including a fastrun program to convert your basic program to run up to 11 times faster, and print drivers for the SPI interface.
- [] B-DESK DESKMASTER - BUS-T - Nickelodeon Graphics - \$19.95
Card files, Address List, Telephone List, Record of Sales and Purchases etc.
- [] B.C. II: GROGS REVENGE - ENT-C - Coleco - \$18.95
No additional information available.
- [] B.C.'S QUEST FOR TIRES - ENT-C - Sierra - \$27.95
No additional information available.
- [] BEAM RIDER - ENT-C - Activision - \$19.95
No additional information available.
- [] BEST ELECTRONIC WORDGAME - ENT-T - Coleco - \$29.95
No additional information available.
- [] BEST OF BRODERBUND - ENT-T - Coleco - \$29.95
2 games. Choplifter and AE.
- [] BEST OF ELECTRONIC ARTS - ENT-T - Coleco - \$19.00
2 games. Hark Hat Mack, and Pinball Construction.
- [] BEST OF SIERRA - ENT-T - Coleco - \$29.95
2 games. Jaw Breaker, and Troll's Tale.
- [] BLACK GOLD - ENT-DT - Image Microcorp - \$24.95
Board style game. Find the hidden oil deposit.
- [] BLACKJACK/POKER - ENT-C - Coleco - \$15.00
Good graphics and effects in two good old games.
- [] BONANZA - HOM-DT - Martin Consulting - \$29.95
15 programs all different, from utilities to games.
- [] BONANZA PACKAGE - ENT-DT - Extended Software Co - \$35.00
156K of Basic Programs. Good varied collection.
- [] BOND AMORT - BUS-DT - CME Software - \$19.95
Bond amortization. Uses the interest method to amortize discounts or premiums on bonds sold, 40 years or less. Uses the smartwriter, available to members for \$12.95.
- [] BOUNTY HUNTER - ENT-DT - Victory Software - \$20.95
Full length text adventure. You play the role of a bounty hunter.
- [] BRAIN STRAINERS - EDU-C - Coleco - \$22.95
Musical note recognition, Pattern Recognition, and Auditory Discrimination.
- [] BUMP N JUMP - ENT-C - Coleco - \$19.00
No additional information available.
- [] BURGER TIME - ENT-C - Coleco - \$15.00
Make your own hamburgers while evading several nasty enemies bound to stop you.

- [] BUSINESS BONUS PACK - BUS-T - Micro 2 - \$32.95
Includes Property Manager, Cash Flow Analysis, Stock Profiles, Investment Analysis, and Address File.
- [] BUSINESS GRAPHS PAK - BUS-T - Nickelodeon Graphics - \$29.00
Plot data in 6 styles. Has dump to printer capability.
- [] CABBAGE PATCH PARK - ENT-C - Coleco - \$15.00
No additional information available.
- [] CABBAGE PATCH PIC. SHOW - ENT-C - Coleco - \$19.00
Childrens entertainment game.
- [] CALCONE - EDU-DT - CME Software - \$14.95
\$9.95 to members.
- [] CAMPAIGN '84 - ENT-T - Sunrise Software - \$14.95
No additional information available.
- [] CANNONBLASTER - ENT-DT - IMCS - \$9.50
Cannon Battle Game. From Integrated Micro Computer Software.
- [] CARNIVAL - ENT-C - Coleco - \$9.95
Shooting gallery.
- [] CASH FLOW ANALYSIS - FIN-T - Micro 2 - \$24.95
Pictures business cash flow.
- [] CASHFLOW BOOKKEEPING - BUS-T - Nickelodeon Graphics - \$20.00
A bookkeeping assistant.
- [] CASHFLOW FINANCIAL PACK - BUS-T - Nickelodeon Graphics - \$39.95
Three programs Cashflow Bookkeeping, Inventory/Invoice, and Financial Data Calculator on one data pack.
- [] CASINO - ENT-T - Data Backup - \$17.00
Three casino games Black Jack, Slots, and Poker.
- [] CASTLE OF DOOM - ENT-T - Challenge Ware - \$19.95
Medieval adventure.
- [] CHART & GRAPH ASSEMBLER - UTI-DT - Extended Software Co - \$24.95
Pie, Vertical Bar, and Step Charts. With more.
- [] CHOPLIFTER - ENT-C - Coleco - \$19.00
No additional information available.
- [] CODEVISOR 4.1 - UTI-DT - Marathon Comp. Press - \$28.50
A data security program for smartwriter, smartbasic, smartlogo, and adamcalc files.
- [] COMMITTED - ENT-DT - Do Not Stamp - \$
Contact Do Not Stamp, Gordon Meyer for more information.
- [] CONGO BONGO - ENT-C - Coleco - \$15.00
No additional information available.
- [] CONVERT - UTI-DT - Unreal Software - \$34.95
Allows you to copy non- ADAM CP/M disks to ADAM format.
- [] COPYCART+ - UTI-DT - MMSG - \$15.00
Copies cartridges to disk.
- [] COSMIC AVENGER - ENT-C - Coleco - \$14.95
No additional information available.
- [] COSSART WARS - ENT-T - Nickelodeon Graphics - \$?
No additional information available.
- [] COUNTING - EDU-DT - CME Software - \$14.95
Interactive, ages 2-6. \$9.95 to members.
- [] CP/M 2.2 & ASSEMBLER - UTI-DT - COLECO - \$29.95
The doorway to a system of programs and languages that are not and will not be available on the Adam system.
- [] CP/M NEVADA BASIC - CPM-DT - NIAD - \$39.95
Available from NIAD. Basic language for the Adam CP/M format.
- [] CREDIT CARD FILE - FIN-T - Micro 2 - \$24.95
Safety record for all credit card information. Instant recall of any card. Catagorized for easy reference.
- [] CUE CARDS - UTI-T - Steve Jacoby Ent. - \$9.95
A deck of 99 cue cards with all of the basic commands Peeks, Pokes, and Calls. Good learning aid for beginners and quick reference for experienced programmers.
- [] DAM BUSTERS - ENT-C - Coleco - \$19.00
No additional information available.
- [] DANCE FANTASY - ENT-C - Fisher Price - \$
No additional information available.
- [] DATA CALC - BUS-T - Adam World Ent. - \$19.95
No additional information available.
- [] DATA FILER - BUS-T - Data Backup - \$17.00
Store names, lists, or groups. Recall and print.
- [] DATACALC - BUS-DT - Strategic Software - \$24.95
Spreadsheets
- [] DATAKEEPER - BUS-T - Challenge Ware - \$19.95
A versatile data base.
- [] DAWN - BUS-T - Magic Wand Ent. - \$29.95
Data Base Program.
- [] DEADLINE - CPM-D - Infocom - \$49.95
No additional information available.
- [] DECATHLON - ENT-C - Activision - \$19.95
No additional information available.

- [] FAST PATCH - UTI-DT - Orphanware - \$
Software provided with their PIA2 printer interface. Super fast patch to their interface, and smartwriter.
- [] FASTFILER - BUS-TD - Strategic Software - \$24.95
Smartfiler type program.
- [] FATHOM - ENT-C - Imagic - \$13.95
No additional information available.
- [] FINANCIAL DATA CALCULATR - BUS-T - Nickelodeon Graphics - \$20.00
Breakeven analysis, Appreciation, Depreciation, and Projected sales and volume.
- [] FLASH FACTS:FLASH BACKS - EDU-T - Coleco - \$9.00
No additional information available.
- [] FLASH FACTS:TRIVIA - ENT-T - Coleco - \$9.00
No additional information available.
- [] FLASH FACTS:VOCABULATOR - EDU-T - Coleco - \$9.00
No additional information available.
- [] FLOWCHART - EDU-DT - CME Software - \$19.95
Programing trainer available for \$12.95 to members.
- [] FOOTBALL - ENT-C - Coleco - \$22.95
No additional information available.
- [] FORTUNE BUILDER - ENT-C - Coleco - \$19.00
No additional information available.
- [] FRACTION FEVER - EDU-C - Spinnaker - \$23.00
No additional information available.
- [] FRANTIC FREDDY - ENT-C - Spectravision - \$24.95
No additional information available.
- [] FRENZY - ENT-C - Coleco - \$22.95
No additional information available.
- [] FROGGER - ENT-C - Parker Brothers - \$19.95
Cross the road if you can.
- [] FROGGER II - ENT-C - Parker Brothers - \$34.95
No additional information available.
- [] FRONT LINE - ENT-C - Coleco - \$15.00
No additional information available.
- [] GALAXIAN - ENT-C - Atarisoft - \$
No additional information available.
- [] GAME PACK I - ENT-DT - Adamagic - \$30.00
28 games run from a menu.
- [] GAMES - ENT-T - Steve Jacoby Ent. - \$19.95
7 programs Checkers, Hangman, Portrait, Liberty, Idaho Sq., Renegade, and Dodge#.
- [] GAMES PACK 1 - ENT-DT - Victory Software - \$20.95
3 programs Gotcha!, Street Sweepers, and Cannoneers.
- [] GATEWAY TO APSHAI - ENT-C - Epyx - \$15.00
No additional information available.
- [] GEOMETRY 1 - EDU-DT - Image Microcorp - \$19.95
Tutors & drills in geometry.
- [] GEOMETRY 2 - EDU-DT - Image Microcorp - \$19.95
More advanced tutoring & drills.(quadrilaterals)
- [] GORF - ENT-C - Coleco - \$15.00
No additional information available.
- [] GRAPHICS EXPERIMENTER - GRA-T - Nickelodeon Graphics - \$39.00
A very extensive set of graphic routines for play and experimentation.
- [] GRAVE ROBBER - ENT-DT - INCO - \$24.95
Requires LOGO.
- [] GREAT INVENTIONS GAME - EDU-T - Parallel Systems - \$19.95
Learn about the world's greatest inventors.
- [] GUESS ADAM - EDU-DT - U.S. Adam Network - \$
No additional information available.
- [] GUST BUSTER - ENT-T - Sunrise Software - \$14.95
Arcade action, especially for the younger set.
- [] GYRUSS - ENT-C - Parker Brothers - \$32.95
No additional information available.
- [] HACKER'S GUIDE TO ADAM - UTI-T - Peter Hinkle - \$17.95
Book & tape. It was one of the first, and still very helpful to anyone just getting acquainted with the Adam.
- [] HEIST - ENT-C - Micro Fun Cartridges - \$15.00
No additional information available.
- [] HERO - ENT-C - Activision - \$27.95
No additional information available.
- [] HI-RES TEXT EDITOR - GRA-T - Nickelodeon Graphics - \$29.00
Type text along side of hi-res graphics.
- [] HOLIDAY SPELLING - EDU-T - Micro 2 - \$24.95
Available soon.
- [] HOME APPLICATIONS & GAME - FIN-DT - Steve Jacoby Ent. - \$19.95
Esp, Music, Medical Records, Saving On Utility Bills, Etc.

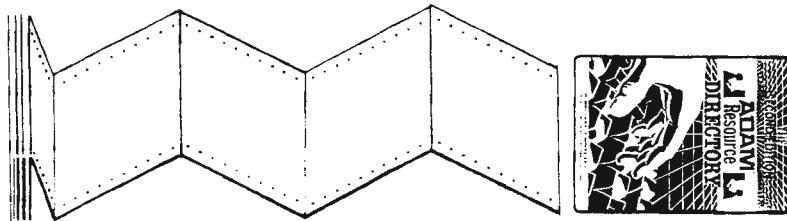

Software

- [] HOME BONUS PACK - FIN-T - Micro 2 - \$32.95
Includes You And Your Checkbook, Insurance File, Credit Card, Micro Money Minder, and Home And Business Inventory.
- [] HOME BUDGET PLANNING - FIN-T - Parallel systems - \$9.95
Weekly, monthly or bi-monthly budgets. 50 expense categories
- [] HOME FILES MANAGER - HOM-T - Parallel Systems - \$19.95
Mailing Lists, Inventory, Mailing Labels, etc.
- [] HOME FINANCE - FIN-T - Steve Jacoby Ent. - \$19.95
4 programs. Super, Mergeaccum, Labels, and Envelopes.
- [] HOME MANAGEMENT SERIES I - HOM-T - Adam World Ent. - \$29.95
Includes Check Book Balancer, Address Label Maker, Computerized Phone Book, School Grade Recorder, Calendar Processor, Home Tutoring System, Metric Conversion System and Currency.
- [] HOME PACK I - HOM-DT - Adamagic - \$28.00
A menu driven collection of programs that will make Adam more useful around the house.
- [] HOME SOFTWARE LIBRARY - ENT-T - Coleco - \$19.95
No additional information available.
- [] HOME/OFFICE INVENTORY - BUS-T - Micro 2 - \$24.95
No additional information available.
- [] HOUSEHOLD II LIBRARY - HOM-T - Davasan Software - \$39.95
15 programs Sign Printer, Diet Minder, Check Printer, Federal Withholding, Envelope Addresser, Etc.
- [] HOUSEHOLD LIBRARY - HOM-T - Davasan Software - \$39.95
15 programs Monthly Calendar, Calorie Counter, Checkbook Control, Home Inventory, Biorhythms, Etc.
- [] ILLUSIONS - ENT-C - Coleco - \$19.00
No additional information available.
- [] INFIDEL - CPM-D - Infocom - \$44.95
Available from NIAD.
- [] INSURANCE FILE - FIN-T - Micro 2 - \$24.95
All information on all types of policies at your fingertips.
- [] INTERSTATE DRIVING GAME - ENT-T - Future Vision - \$9.95
No additional information available.
- [] INTRO PHYSICS - EDU-DT - CME Software - \$14.95
HS to Freshman. \$9.95 to members.
- [] INTRO TRIG - EDU-DT - CME Software - \$14.95
Advanced student to high school, Sine, Cosine, etc. \$9.95 to members.
- [] INVENTORY - HOM-T - Data Backup - \$17.00
You can make an inventory of your house or apartment.
- [] INVENTORY/INVOICE - BUS-T - Nickelodeon Graphics - \$20.00
An inventory, invoice assistant.
- [] INVESTMENT ANALYSIS - BUS-T - Micro 2 - \$24.95
No additional information available.
- [] INVESTMENT ANALYST - BUS-DT - Marathon Comp. Press - \$25.50
P/E computation and projection, Earning per share projection and growth, Ten day moving graph, Portfolio growth, and Mini transaction data base.
- [] IRA HISTORY - HOM-DT - Kray Software - \$20.00
Listing only \$10.00. Keeps track of IRA accounts.
- [] JAMES BOND - ENT-C - Parker Brothers - \$34.95
No additional information available.
- [] JANES RECIPES - HOM-DT - NIAD - \$9.00
\$7.00 for Disk. Requires Recipe Filer.
- [] JEOPARDY - ENT-DT - Coleco - \$5.00
Now in the Public Domain available from NIAD.
- [] JKL UTILS - UTI-D - Overpriced Software - \$49.95
A very complete set of utilities, including compression of disk space, unerase files, patch trashed directories, etc. 31 utilities run from a menu.
- [] JUKE BOX - ENT-C - Spinnaker - \$23.95
No additional information available.
- [] JUMPMAN JUNIOR - ENT-C - Epyx Cartridges - \$15.00
Arcade action game, climbing and jumping along a series of ladders.
- [] KEYMAN - ENT-T - Challenge Ware - \$19.95
Need LOGO, for kids ages 6-12.
- [] KEYSTONE KAPERS - ENT-C - Activision - \$27.95
No additional information available.
- [] KNOWLEDGE FACTORY - EDU-T - Nickelodeon Graphics - \$?
No additional information available.
- [] KOPYKAT - UTI-DT - Reedy Software - \$19.95
Copies all but some of the Super Game Packs.
- [] L.V.A.C. ARCHIVES I - ENT-DT - Las Vegas Adam Club - \$9.95
11 programs and instructions. IQ, Catalog, Letter Match, Snake Eyes, Card Trick, Color Pokes, Morse Code, Match'em, Triv. Maker, Triv. Game, and Questionaire.
- [] LA GREET - EDU-DT - CME Software - \$14.95
Have Adam print in foreign languages. \$9.95 to members.
- [] LABEL LASHER - BUS-DT - IMCS - \$11.50
Enhances the label making process. Helps to get around the limitations of the early SmartFiler, and present SmartWriter. From Integrated Micro Computer Software.
- [] LADY BUG - ENT-C - Coleco - \$19.95
Childrens arcade game similar to PackMan.
- [] LEARNING MORSE CODE - EDU-DT - Image Microcorp - \$19.95
Learning tool for morse code. Vary speed & frequency.

- [] LEARNING WITH LEEPER - EDU-C - Sierra - \$25.00
Excellent childrens learning game package.
- [] LINKING LOGIC - EDU-C - Fisher Price - \$
No additional information available.
- [] LIST - BUS-DT - CME Software - \$19.95
Inventory, Payroll, Checkbook, and Cash Accounting. \$12.95 to members.
- [] LOGIC LEVELS - EDU-C - Fisher Price - \$
No additional information available.
- [] LOGO PACK I - UTI-DT - Adamagic - \$28.00
A menu driven collection of programs written in smartLOGO that fully utilize
the sound and graphics capabilities of ADAM.
- [] LOGO UTILITIES - UTI-DT - U.S. Adam Network - \$
For more information contact U.S. Adam Network.
- [] LOOPING - ENT-C - Coleco - \$19.95
Airplane arcade obstacle game.
- [] LOUISIANA JONES - ENT-DT - Challenge Ware - \$7.00
Guide Jones through the swamps, and then through the dangerous land.
- [] M-DESKMASTER - BUS-T - Nickelodeon Graphics - \$19.95
keep track of small bus. expenses & income.
- [] MAILFONE - BUS-T - Steve Jacoby Ent. - \$19.95
Mailing/telephone system
- [] MAKE CHANGE - EDU-T - Micro 2 - \$24.95
Avialable soon
- [] MAKE-A-FACE - ENT-C - Spinnaker - \$
No additional information available.
- [] MATH ONE - EDU-DT - CME Software - \$14.95
\$9.95 to members. Add, Subtract, Multiply, and Divide. Ages 6-12.
- [] MATH QUIZ - EDU-T - Data Backup - \$17.00
Lets you choose different levels of difficulty for basic math practice.
- [] MATH-TUTOR - EDU-DT - Terry's Games - \$19.95
An educational program for all ages.
- [] MATHHELPER - EDU-DT - IMCS - \$11.50
Various routines to convert dicimals, fractions, and percentages. From
Integrated Micro Computer Software.
- [] MEDIA-AID - UTI-DT - Walters Software Co. - \$21.95
Init, Hellobcd, Modifier, Toolkit, Copy, Purge, Hmodify, Hrecover, and
Manager programs.
- [] MEMORY MANOR - EDU-C - Fisher Price - \$
No additional information available.
- [] MICRO MATH - EDU-T - Micro 2 - \$24.95
Grades 2-5 addition & mult. skills, animated graphics.
- [] MICRO MONEY MINDER - FIN-T - Micro 2 - \$24.95
Expense records.
- [] MINER 2049ER - ENT-C - Micro Fun Cartridges - \$15.00
Challenging arcade actiion game.
- [] MONKEY ACADEMY - EDU-C - Coleco - \$18.95
Ages 8-adult, improving math skills.
- [] MONTEZUMA'S REVENGE - ENT-C - Parker Brothers - \$32.95
No additional information available.
- [] MOONSWEeper - ENT-C - Imagic - \$13.95
No additional information available.
- [] MOUNTAIN KING - ENT-T - Sunrise Software - \$14.95
No additional information available.
- [] MOUSE TRAP - ENT-C - Coleco - \$19.95
Childrens arcade game similar to PackMan.
- [] MR. DO! - ENT-C - Coleco - \$22.95
Challenge the maze, similar to Packman.
- [] MR. DO'S CASTLE - ENT-C - Parker Brothers - \$32.95
No additional information available.
- [] MULTI-CART BACKUP - UTI-DT - Best Software - \$19.95
Assembly language, menu driven. Holds 5 cartridges to a disk, 8 to datapack
requires backup program- Example Pack Copy, Hackers Guide to Adam, etc.
- [] MULTICART BACKUP - UTI-DT - Practical Programs - \$10.95
Backup nearly all your cartridges 8 to a datapack, and 5 to a disk. Game
title directory accessed from any Coleco or Atari compatable joystick.
- [] MULTIWRITE - BUS-T - Strategic Software - \$39.95
64 column Word Processing with no special equipment required.
- [] NOVA BLAST - ENT-C - Imagic - \$13.95
No additional information available.
- [] OIL'S WELL - ENT-C - Sierra - \$25.00
No additional information available.
- [] OMEGA RACE - ENT-C - Coleco - \$22.95
Use the Roller Controller.
- [] ONE ON ONE - ENT-C - Micro Fun Cartridges - \$21.95
Bird, Irving, and You.
- [] PACKCOPY - UTI-T - Sage Enterprises - \$29.95
Makes backup copies of most Adam software. PACKCOPY II now available for
small fee to present owners of PACKCOPY.

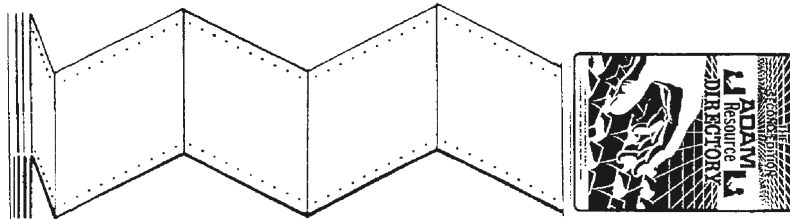

Software

- [] PACKCOPY II - UTI-DT - Sage Enterprises - \$29.95
Update of the first commercially available copy program. Will copy all the super game packs, including the short games as well as copying Smart Basic for use from disc.
- [] PAINTMASTER - UTI-T - Strategic Software - \$24.95
Allows you to design Hi-Resolution graphic designs to be saved on disc or tape.
- [] PARTY TRIVIA GAME - ENT-T - Parallel Systems - \$15.95
Categories TV, Hollywood, 50's, 60's, Baseball, and Football.
- [] PAY - BUS-DT - Steve Jacoby Ent. - \$19.95
Accounts Payable Records, Discounts Available.
- [] PAYROLL - BUS-T - Steve Jacoby Ent. - \$19.95
Keeps track of each employees account including deductions and special items Prints checks, pay envelopes, and payroll summary.
- [] PEPPER II - ENT-C - Coleco - \$22.95
No additional information available.
- [] PERSONAL ACCOUNTANT - FIN-T - Softsync, Inc. - \$19.95
Compiles financial reports, data base, amortization, and payment schedules.
- [] PERSONAL CHECKBOOK - FIN-T - Parallel Systems - \$19.95
Complete checkbook record keeping system. Monthly summaries, etc.
- [] PHYSICSONE - EDU-DT - CME Software - \$14.95
\$9.95 to members.
- [] PIANOMAN - MUS-T - Davasan Software - \$29.95
Electronic version of the Old Player Piano with new twists. Teaches music and Fundamentals.
- [] PINBALL MACK - ENT-DT - Public Domain - \$5.00
Available from NIAD.
- [] PITFALL - ENT-C - Activision - \$27.95
No additional information available.
- [] PITFALL II - ENT-C - Activision - \$27.95
No additional information available.
- [] PITSTOP - ENT-C - Epyx - \$15.95
No additional information available.
- [] PLANETFALL - CPM-D - Infocom - \$39.95
No additional information available.
- [] PLOT & PRINT - GRA-DT - Challenge Ware - \$7.00
Design a picture in low resolution graphics and then print it out with your letter quality printer.
- [] POPEYE - ENT-C - Parker Brothers - \$19.95
Defeat Brutus and the Witch in this arcade game.
- [] POWERPRINT - BUS-TD - Strategic Software - \$24.95
line centering, justification, etc for the printer. Requires you to use preformatted disc for features to be available.
- [] PRINTSHOP - UTI-DT - CME Software - \$14.95
Signs, cards, etc. will be updated for Dot Matrix printer. Available to members for 9.95
- [] PRINTSHOP EXTRA - UTI-DT - CME Software - \$14.95
Similar to Printshop. Available to members for 9.95.
- [] PROPERTY MANAGEMENT - FIN-T - Micro 2 - \$24.95
Tenant & rental records.
- [] PS EXTRA - UTI-DT - CME Software - \$14.95
Use with PRINTSHOP Program. \$9.95 to members.
- [] Q-BERT - ENT-C - Parker Brothers - \$19.95
Popular arcade game.
- [] Q-BERT II - ENT-C - Parker Brothers - \$34.95
No additional information available.
- [] QUEST FOR QUINTANA ROO - ENT-T - Sunrise Software - \$14.95
No additional information available.
- [] QUICKCOPY - UTI-DT - GJMG Enterprises - \$14.95
\$11.95 on disk. Machine language copy program. Very fast, uses 40K buffer, or 104K buffer with the 64K expander. Copies blocks or Files.
- [] QUICKFAX QUEST I - EDU-DT - Data Doctor - \$24.95
This package includes three major files, Elements of Chemistry (103), U.S. State Capitals (50), and World Capitals (196). It plays as an arcade game, with paddle controls, or as a fill in the blank.
- [] QUICKFAX QUEST II - EDU-DT - Data Doctor - \$24.95
Three major files Doctors and Diseases, Human Bones and Muscles, and Medical Terms. Plays as Quickfax I.
- [] RAMTEST - UTI-D - Orphanware - \$12.00
Test the 64K expander.
- [] RATIOS - BUS-DT - CME Software - \$19.95
Financial analysis package. Calculates the profitability, liquidity, leverage and activity ratios of a firm. Available to members for \$12.95.
- [] READING FUN - EDU-T - Micro 2 - \$24.95
Grades 2-5, teaching vowels & rhyming words.
- [] RECEIVE - BUS-T - Steve Jacoby Ent. - \$19.95
An accounts receivable program
- [] RECIPE - HOM-T - Steve Jacoby Ent. - \$19.95
Recipe filer.
- [] RECIPE FILER - HOM-TD - Coleco - \$15.95
Good format for keeping track of all those rat makers, includes many recipes for you to try. Now available on disk via a copy service from NIAD for a \$4 fee.
- [] REEDY LIBRARY - UTI-TD - Reedy Software - \$24.95
Disk 22.95 Tape 24.95. Includes Michigana Jones, Hi-Res Texteditor, Videopaint, Picture Subroutine Maker, and others.

- [] RENUMBER - UTI-DT - Kray Software - \$17.00
Listing only \$7.00. Renumbers lines in Basic.
- [] RESUME - BUS-T - Challenge Ware - \$19.95
Instant personalized resume.
- [] RIB - UTI-T - Tapeware Technology - \$32.95
2 Data Packs. 14 utilities and 5 tutorials.
- [] RIVER RAID - ENT-C - Activision - \$27.95
No additional information available.
- [] ROC-N-ROPE - ENT-C - Coleco - \$15.00
No additional information available.
- [] ROCKY - ENT-C - Coleco - \$15.00
No additional information available.
- [] ROLLOVERTURE - MUS-T - Sunrise Software - \$14.95
No additional information available.
- [] ROOT BEER TAPPER - ENT-C - Coleco - \$19.00
No additional information available.
- [] SAC. TO THE SPIDER QUEEN - ENT-T - Avimar Inc. - \$19.95
A full length text adventure.
- [] SAMMY LIGHTFOOT - ENT-C - Sierra - \$25.00
No additional information available.
- [] SAVINGS & LOAN - FIN-DT - Steve Jacoby Ent. - \$19.95
Home finances.
- [] SAVINGS & LOANS - FIN-DT - Victory Software - \$20.95
Calculates interest, principal, monthly payments, annuity funds, savings accounts, IRA's, etc.
- [] SCARRY'S ELEC. WORD BOOK - EDU-T - Coleco - \$19.95
Excellent childrens word trainer.
- [] SCREEN CHOP - CPM-D - Public Domain - \$
Available from Elliam Associates.
- [] SEARCH FOR RUBY CHALICE - ENT-T - INCO - \$19.95
No additional information available.
- [] SECRET M. - EDU-DT - CME Software - \$14.95
Code & decode your secret messages.
- [] SHAPEMASTER I - GRA-T - Nickelodeon Graphics - \$29.00
Create your own shapes for use in games & commercial programs.
- [] SIGNSHOP - UTI-T - Startegic Software - \$24.95
Allows for the creation of signs of various types. Note: to be used only with the standard Adam printer.
- [] SMART BASIC - UTI-T - Coleco - \$24.00
Basic Language for the Adam computer.
- [] SMART BASIC 2.0 - UTI-T - Coleco - \$
Improved version of the original Smart Basic never released by Coleco. As long as there is no eluding to Coleco in any way Coleco says they have no problem with its distribution.
- [] SMART LETTERS & FORMS - HOM-DT - Coleco - \$15.95
Good format for home letter and form writing. Convert your tape version to disk via a copy service from NIAD for a \$4 fee.
- [] SMART LOGO - GRA-T - Coleco - \$29.95
A graphics type language for the Adam computer.
- [] SmartBASIC BONANZA - ENT-T - Martin Consulting - \$34.95
15 programs, Large variety, Games, Filer, Assembler, Breakout, Othello, Design, Sounder, Etc.
- [] SMARTBEST - UTI-DT - Data Doctor - \$18.95
27 enhancements to Smartbasic including better control of color and sound, and several new commands.
- [] SMARTFILER - HOM-DT - Coleco - \$15.95
Version 27D now available to present owners on disc for \$4 copy charge from NIAD. This version has been fixed to print addresses on standard labels.
- [] SMARTGAMES PACK - ENT-DT - NIAD - \$11.95
\$9.95 for disk.
- [] SMARTSPELLER - BUS-T - Adam World Ent. - \$39.95
Dictionary for word processing.
- [] SMARTSPELLER - BUS-DT - Strategic Software - \$39.95
Finds misspelled words in wordprocessing documents.
- [] SMARTTRIX I - UTI-DT - Data Doctor - \$34.95
A very comprehensive utility for Adam programmers. It includes 10 advanced programs and scores of programming tricks and routines, including a fastload speedup routine.
- [] SMARTTYPE - HOM-DT - Reedy Software - \$24.95
A wordprocessor with many of the functions left out of Smartwriter, including newspaper style two column to the page printing.
- [] SMURF PAINT N'PLAY - EDU-C - Coleco - \$18.95
Ages 4-10, Role Play, Color & Shape Recognition, Graphic Composition. Etc.
- [] SMURF RESCUE - ENT-C - Coleco - \$19.95
Childrens entertainment game.
- [] SOFTPACK 1 - BUS-DT - E & T Software - \$19.95
Contains four programs Softcheck, Checkbook Totalizer, Checkbook Reconciler, and Softmailer.
- [] SOLAR SYSTEM - EDU-T - A-ware Educational - \$12.00
Learn more about the Solar System.
- [] SORCERER - CPM-D - Infocom - \$43.00
Text Adventure. Available from NIAD.
- [] SOUND SYNTHESIZER I - MUS-D - IMCS - \$4.00
Sound and noise generator designed somewhat like a piano keyboard. From Integrated Micro Computer Software.

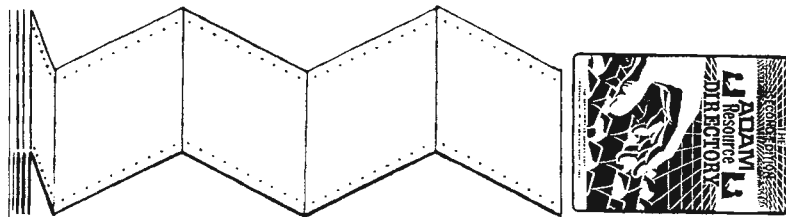

Software

- [] SP-1 CUSTOM PRINTER - UTI-D - Eve Electronics - \$25.00
Custom software to be used with the Eve SP-1 interface with your dot matrix printer.
- [] SPACE FURY - ENT-C - Coleco - \$19.95
No additional information available.
- [] SPACE PANIC - ENT-C - Coleco - \$19.95
No additional information available.
- [] SPACE RESCUE, GAME CREAT. - ENT-DT - Challenge Ware - \$7.00
First rescue the astronauts and then make your own game in Logo.
- [] SPANISH VOCABULARIAN - EDU-ST - Marathon Comp. Press - \$25.50
A vocabulary program of over 1,500 words.
- [] SPECTRON - ENT-C - Spectravision - \$24.95
No additional information available.
- [] SPELLING QUIZ - EDU-T - Data Backup - \$17.00
Allows you to input a spelling list and Adam will change the order of the list and ask you to spell them.
- [] SPLAT - UTI-D - Overpriced Software - \$64.95
A extensive de-bugging set of routines, definately not routine, and not for the novice.
- [] SPY HUNTER - ENT-C - Coleco - \$19.00
Road race arcade action with many enemies and pitfalls along the road.
- [] SQUEEZE - UTI-DT - Terry's Games - \$19.95
Eliminates deleted files and packs remaining files together on the disk or tape so there is no wasted space.
- [] STAR TREK - ENT-C - Coleco - \$19.00
Simplified version of the computer classic, in arcade format.
- [] STAR WARS - ENT-C - Parker Brothers - \$34.95
No additional information available.
- [] STARCROSS - CPM-D - Infocom - \$49.95
Available from NIAD.
- [] STATECAPITALS - EDU-DT - CME Software - \$14.95
US State Capitals. Available to members for \$9.95.
- [] STATEGY PACK 1 - ENT-DT - Victory Software - \$20.95
4 programs Payoff, HI-Q, Jump, Othello.
- [] STATES & CAPITALS - EDU-T - Data Backup - \$17.00
This program is a Quiz of U.S. States and Capitals.
- [] STATES AND CAPITALS - EDU-T - Parallel Systems - \$15.95
Learn the United States States and Capitals.
- [] STELLAR 5 - EDU-DT - Hanania Enterprises - \$36.00
Large Astronomy information and calculation program.
- [] STOCK MARKET GAME - ENT-DT - Image Microcorp - \$24.95
Board style game. Works just like the real stock market.
- [] STOCK PROFILE - FIN-T - Micro 2 - \$24.95
Chart profit/loss.
- [] STRATEGIC ALT - BUS-DT - CME Software - \$19.95
A marketing package. Helps small business managers achieve the desired goals and objectives. Available to members for \$12.95.
- [] STRATEGY STRAIN I - ENT-DT - Data Doctor - \$24.95
A collection of advanced versions of nine computer classics, including Klingon Challenge, Lunar Module Simulation, and Towers of Hanoi.
- [] SUB ROC - ENT-C - Coleco - \$15.00
No additional information available.
- [] SUPER BUCK ROGERS - ENT-T - Coleco - \$19.00
Now available on disk via copy service from NIAD for a \$4 fee.
- [] SUPER COBRA - ENT-C - Parker Brothers - \$32.95
Fighter Pilot arcade game.
- [] SUPER CROSS FORCE - ENT-C - Spectravision - \$24.95
No additional information available.
- [] SUPER SKETCH - GRA-C - Personal Peripherals - \$32.00
Allows for the creation of video graphics with a controller pad, and a cartridge compatible with the Adam.
- [] SUPER SUB ROC - ENT-DT - Public Domain - \$5.00
Available from NIAD.
- [] SUPER ZAXXON - ENT-DT - Coleco - \$19.95
Now available on disk via copy service from NIAD for a \$4 fee.
- [] SUPERONE - BUS-DT - Steve Jacoby - \$19.95
Keeps track of two checking accounts, and prints checks on the printer.
- [] SUSPENDED - CPM-D - Infocom - \$49.95
Available from NIAD.
- [] TARZAN - ENT-C - Coleco - \$19.00
No additional information available.
- [] TAX 1040 - HOM-DT - Extended Software - \$24.00
Software for helping compute your taxes contact Extended Software for years available.
- [] TEACHER'S FILE - EDU-DT - CME Software - \$19.95
Gathers stats & keeps files on students. Available to members for \$12.95.
- [] TEACHER'S HELP - EDU-DT - CME Software - \$19.95
Assists teachers in calculating statistics for exams & quizzes. Available to members for \$12.95.
- [] TELLY TURTLE - EDU-C - Coleco - \$18.95
Ages 5-15, Intro to programming, Logical thinking, and Creativity.

- [] THE SECRETARY - CPM-D - Public Domain - \$12.00
Available from Elliam Associates. A useful word processing program.
- [] THRESHOLD - ENT-C - Sierra - \$25.00
No additional information available.
- [] TIME PILOT - ENT-C - Coleco - \$19.95
Aircraft arcade fighter action from bi-planes to modern fighter helicopters.
- [] TOMB - ENT-T - INCO - \$19.95
Text adventure game.
- [] TOOL PACK I - UTI-DT - Adamagic - \$37.00
Backup, Cartcopy, Disassembler, Assembler, Ramview, Romview, and Binview.
- [] TREK - ENT-DT - Victory Software - \$20.95
Destroy the Klingon invasion before time runs out. A classic.
- [] TRIGONE - EDU-DT - CME Software - \$14.95
\$9.95 to members.
- [] TROLS TALE - ENT-DT - Public Domain - \$5.00
Available from NIAD.
- [] TUNEMAKER - MUS-T - Nickelodeon Graphics - \$8.00
Sold only w/Hi-res Text Editor or Shapemaster I
- [] TURBLOAD - UTI-T - Strategic Software - \$29.95
Transforms your Basic program file into a new more efficient version that loads up to 10 times faster.
- [] TUTANKUM - ENT-C - Parker Brothers - \$32.95
No additional information available.
- [] TYPETEST II - EDU-T - Nickelodeon Graphics - \$25.00
Multi-level skill developer for typing skills.
- [] ULTIMATE ADVENTURE - ENT-T - INCO - \$19.95
Text adventure game.
- [] UNCLE ERNIES TOOL KIT - UTI-DT - Uncle Ernie's Softwr - \$23.00
\$25.00 for DP, \$23.00 for Disk. Several advanced utilities.
- [] UTILITIES - UTI-T - Steve Jacoby Ent. - \$19.95
4 programs Music, Sounds, and Surprise.
- [] VEGAS SLOTS - ENT-DT - IMCS - \$8.50
A slot machine program. From Integrated Micro Computer Software.
- [] VENTURE - ENT-C - Coleco - \$19.95
Multi screened arcade game with several different rooms to get through and collect the treasure.
- [] VICTORY - ENT-C - Coleco - \$9.95
No additional information available.
- [] VIDEO TUNES - MUS-T - Future Vision - \$26.95
No additional information available.
- [] VIEWLOAD - UTI-DT - Practical Programs - \$10.95
Basic HELLO program showing up to 32 program on the screen. facilitates manipulation of the programs including run, load, catalog, etc. Also allows for permanent configuration of colors etc.
- [] WACKY WORD GAMES - ENT-T - Coleco - \$15.95
No additional information available.
- [] WAITER! - ENT-DT - Challenge Ware - \$7.00
Take orders and then bring them to the correct table.
- [] WAR GAMES - ENT-C - Coleco - \$19.00
You command the U.S. nuclear defense arsenal. You will either force peace talks or perish in the total destruction of the planet Earth.
- [] WING WAR - ENT-C - Imagic - \$13.95
No additional information available.
- [] WITNESS - CPM-D - Infocom - \$39.95
Available from NIAD.
- [] WIZARD OF ID'S WIZ MATH - EDU-C - Sierra - \$24.95
Educational math game.
- [] WORD BUG - EDU-T - Micro 2 - \$24.95
New product info unavailable at press time.
- [] WORLD CAPITALS - EDU-T - Parallel Systems - \$15.95
Learn world capitals with colorful graphics computer sytle.
- [] WORLD GEOGRAPHY - EDU-T - A-ware Educational - \$12.00
Learn more about World geography.
- [] WRITER'S ASSISTANT - BUS-T - Davasan Software - \$39.95
Assists in term papers, Form letters, Invitations, Charts, Graphs, and Newsletters. Works with Smartwriter. Line centering and right justification.
- [] YOU & YOUR CHECKBOOK - FIN-T - Micro 2 - \$24.95
A hassle free balancing of your monthly statement. Produces printout copy for your records.
- [] ZAXXON - ENT-C - Coleco - \$19.95
Aircraft arcade fighter game.
- [] ZENJI - ENT-C - Activision - \$27.95
No additional information available.
- [] ZORK I - CPM-D - Infocom - \$39.95
Available from NIAD.
- [] ZORK II - CPM-D - Infocom - \$44.95
Available from NIAD.
- [] ZORK III - CPM-D - Infocom - \$44.95
Available from NIAD.

Software

Adam Software by Category...

This section simply re-lists all the programs listed in the previous pages dividing them into various categories.. We have assigned each program to its most commonly used category. (It is possible that you would list a particular program in another category.) Use this section as a "quick-reference" for your programming needs. You can then look up the details in the **MASTER SOFTWARE LISTING** beginning on page 6.

CP/M

We have only listed a few CP/M programs here. Please refer to the CP/M info later in the software section for more details.

CP/M NEVADA BASIC	SCREEN CHOP	WITNESS
DEADLINE	SORCERER	ZORK I
ENCHANTER	STARCROSS	ZORK II
INFIDEL	SUBPENED	ZORK III
PLANETFALL	THE SECRETARY	

Business

Graphics

- PLOT & PRINT
- SMART LOGO
- SUPER SKETCH

- ADAM CALC LIST
- ADAM FILER MAILFONE
- BOND AMORT MULTIWRITE
- BUSINESS BONUS PACK PAYROLL
- BUSINESS GRAPHS PAK POWERPRINT
- CASHFLOW BOOKKEEPING PROPERTY MANAGEMENT
- CASHFLOW FINANCIAL PACK RATIOS
- DATA CALC RECEIVE
- DATA FILER RESUME
- DATA CALC SMARTPELLER
- DAWN SMARTPELLER
- FASTFILER SOFTPACK 1
- FINANCIAL DATA CALCULATR STRATEGIC ALT
- HOME/OFFICE INVENTORY SUPERONE
- INVENTORY/INVOICE WRITER'S ASSISTANT
- INVESTMENT ANALYSIS
- INVESTMENT ANALYST
- LABEL LASHER

Home

- ADAM AGENDA INVENTORY
- ADAMBANNER IRA HISTORY
- ADDRESS BOOK & AUTODIALR JANES RECIPES
- BONANZA RECIPE
- DIGI-CLOCK RECIPE FILER
- FAMILY ACCOUNTING SMART LETTERS & FORMS
- HOME MANAGEMENT SERIES I SMARTFILER
- HOME PACK I SMARTTYPE
- HOUSEHOLD II LIBRARY TAX 1040
- HOUSEHOLD LIBRARY



Educational

ADAM'S RIB
ADVENTURE PACK 1
ADBASIC
ADVENTURER
ALPHABET ZOO
AMERICA AT WAR
EASYBASIC
EDUCATION
EDUCATION BONUS PACK
EDUCATION LIBRARY
EDUCATION PACK I
EDUCATIONAL PROGRAMS
ELECTRONIC FLASHCARD MKR
EUROCAPITALS
EXPERTYPE
FLASH FACTS:FLASH BACKS
FLASH FACTS:VOCABULATOR
FLOWCHART
FRACTION FEVER
GEOMETRY 1
GEOMETRY 2
GREAT INVENTIONS GAME
GUESS ADAM
HOME APPLICATIONS & GAME
INTRO TRIG
KNOWLEDGE FACTORY
LA GREET
LEARNING MORSE CODE
LEARNING WITH LEEPER
LINKING LOGIC
LOGIC LEVELS
MATH ONE
MATH QUIZ
MATH-TUTOR
MATHHELPER
MEMORY MANOR
PHYSICSONE
QUICKFAX QUEST I
QUICKFAX QUEST II

SCARRY'S ELEC. WORD BOOK
SMURF PAINT N'PLAY
SOLAR SYSTEM
SPANISH VOCABULARIAN
SPELLING QUIZ
STATECAPITALS
STATES & CAPITALS
STATES AND CAPITALS
STELLAR 5
SUPER CROSS FORCE
TELLY TURTLE
WIZARD OF ID'S WIZ MATH
WORD BUG
WORLD CAPITALS
WORLD GEOGRAPHY

CASH FLOW ANALYSIS
HOME BONUS PACK
HOME BUDGET PLANNING
HOME FINANCE
PERSONAL ACCOUNTANT
PERSONAL CHECKBOOK
SAVINGS & LOAN
SAVINGS & LOANS
STOCK PROFILE
YOU & YOUR CHECKBOOK

Finances

Utilities

ADAM DIAGNOSTIC
ADAMLINK II
AUTOAID
BACKUP 3.0
BACKUP+ 3.0
BASIC MANAGER
BASIC PACK I
BLACKJACK/POKER
CHART & GRAPH ASSEMBLER
CODEVISOR 4.1
CONVERT
COPYCART+

CP/M 2.2 & ASSEMBLER
CUE CARDS
DRIVE STATION
ESU
EXTENDED BASIC UTILITIES
FAST PATCH
HACKER'S GUIDE TO ADAM
JKL UTILS
KOPYKAT
LOGO PACK I
LOGO UTILITIES
MEDIA-AID
MULTI-CART BACKUP
MULTICART BACKUP
PACKCOPY
PACKCOPY II
PAINTMASTER
PRINTSHOP EXTRA
PS EXTRA
QUICKCOPY
RAMTEST
REEDY LIBRARY
RENUMBER
RIB
SIGNSHOP
SMART BASIC
SMART BASIC 2.0
SMARTBEST
SMARTTRIX I
SP-1 CUSTOM PRINTER
SPLAT
SQUEEZE
TOOL PACK I
TURBOLOAD
UNCLE ERNIES TOOL KIT
UTILITIES
VIEWLOAD

Enter tainment

2010 ACTION
2010 TEXT ADVENTURE
32 BASIC PROGRAMS
ABC'S
ACTIVISION DECATHALON
ADDRESS FILE
ADDRESS LABELS
ADVENTURE PACK
ADVENTURE PACK 2
ADVENTURE PACK I
ADVENTURE PACK II
ANTARTIC ADVENTURE
ANALYSIS
APPIAN WAY
AQUATTACK
ARTISTS PAD
AWARDS & CERTS
B-DESK DESKMASTER
B.C. II: GROGS REVENGE
BASIC GAME LIBRARY
BEST ELECTRONIC WORDGAME
BEST OF BRODERBUND
BEST OF ELECTRONIC ARTS
BEST OF SIERRA
BLACK GOLD
BONANZA PACKAGE
BOUNTY HUNTER
BRAIN STRAINERS
BURGER TIME
B.C.'S QUEST FOR TIRES
BEAM RIDER
BUMP N JUMP
CABBAGE PATCH PIC. SHOW
CABBAGE PATCH PARK
CALCONE
CAMPAIGN '84
CANNONBLASTER
CARNIVAL
CASINO
CASTLE OF DOOM

CHOPLIFTER Entertainment Cont.

COMMITTED	GAMES PACK 1	OIL'S WELL	SUPER SUB ROC
CONGO BONGO	GATEWAY TO APSHAI	OMEGA RACE	SUPER ZAXXON
COSMIC AVENGER	GORF	ONE ON ONE	TARZAN
COSSART WARS	GRAPHICS EXPERIMENTER	PARTY TRIVIA GAME	TEACHER'S FILE
COUNTING	GRAVE ROBBER	PAY	TEACHER'S HELP
CREDIT CARD FILE	GUST BUSTER	PEPPER II	THRESHOLD
DAM BUSTERS	GYRUSS	PINBALL MACK	TIME PILOT
DESTRUCTOR	HEIST	PITFALL	TOMB
DRAGON FIRE	HERO	PITFALL II	TREK
DR SEUSS MIX-UP PUZZLE	HI-RES TEXT EDITOR	PITSTOP	TRIGONE
DUKES OF HAZZARD	HOLIDAY SPELLING	POPEYE	TROLS TALE
DANCE FANTASY	HOME FILES MANAGER	Q-BERT	TUTANKUM
DATAKEEPER	HOME SOFTWARE LIBRARY	Q-BERT II	TUNEMAKER
DECATHLON	ILLUSIONS	QUEST FOR QUINTANA ROO	TYPETEST II
DIABLO	INSURANCE FILE	READING FUN	ULTIMATE ADVENTURE
DISASSEMBLER	INTERSTATE DRIVING GAME	RIVER RAID	VEGAS SLOTS
DONKEY KONG	INTRO PHYSICS	ROC-N-ROPE	VENTURE
DONKEY KONG JR	JEOPARDY	ROCKY	VICTORY
DRAGON'S CAVERN	JUKE BOX	ROOT BEER TAPPER	WACKY WORD GAMES
DRAGON'S LAIR	JUMPMAN JUNIOR	SAC. TO THE SPIDER QUEEN	WAITER!
DUEL	JAMES BOND	SAMMY LIGHTFOOT	WAR GAMES
DUNGEON ADVENTURE	KEYSTONE KAPERS	SEARCH FOR RUBY CHALICE	WING WAR
EARN-SAVE HISTORY	KEYMAN	SECRET M.	ZAXXON
EASYPERT	L.V.A.C. ARCHIVES I	SHAPEMASTER I	ZENJI
EDUCATION II LIBRARY	LOOPING	SmartBASIC BONANZA	
ELECTRONIC GAME PACK	LADY BUG	SMARTGAMES PACK	
F-DESK MASTER	LOUISIANA JONES	SMURF RESCUE	
FACE MAKER	M-DESKMASTER	SPACE FURY	
FAMILY FEUD	MAKE CHANGE	SPACE PANIC	
FANTASY GAMER	MAKE-A-FACE	SPACE RESCUE, GAME CREAT	
FATHOM	MICRO MATH	SPACE RESCUE, GAME CREAT	
FLASH FACTS:TRIVIA	MONTEZUMA'S REVENGE	SPECTRON	
FOOTBALL	MOONSWEeper	SPY HUNTER	
FORTUNE BUILDER	MOUNTAIN KING	STAR TREK	
FRANTIC FREDDY	MOUSE TRAP	STAR WARS	
FRENZY	MR. DO!	STRATEGY PACK 1	
FROGGER	MR. DO'S CASTLE	STOCK MARKET GAME	
FROGGER II	MINER 2049ER	STRATEGY STRAIN I	
FRONT LINE	MONKEY ACADEMY	SUB ROC	
GALAXIAN	MICRO MONEY MINDER	SUPER BUCK ROGERS	
GAME PACK I	NOVA BLAST	SUPER COBRA	
GAMES			

Music

PIANOMAN
ROLLOVERTURE
SOUND SYNTHESIZER I
VIDEO TUNES

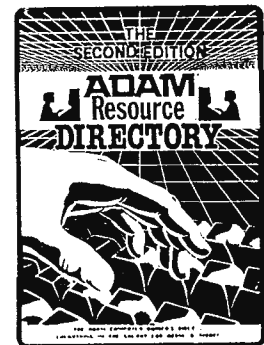

The ADAM Resource
 2025 RELEASE UNDER E.O. 14176

Adam CP/M Software Info

CP/M opens up an entirely different world to the ADAM user. Since CP/M is common to most computers there are literally tens of thousands of programs available in CP/M format. It is, of course, impossible for us to list them all here. We do, however, have some suggestions to get you going in this area of software. We submit the following bits of info & sources:

1. SOURCE - *Elliam Associates* carries a large catalog of CP/M programs for many different formats including ADAM. If you're serious about CP/M you need to obtain their 41-page catalog which lists thousands of programs. The catalog sells for \$7.50 Each volume listed in Elliam's catalog is \$12.00 They also offer a transfer service to convert CP/M disks to the ADAM format.

2. SOURCE - *SAGE ENTERPRISES* has available "CONVERT" a program written to convert the following formats to the ADAM:
 Zenith 100 CP/M-85 SSDD Disk
 IBM PC-86 SSDD Format Disks
 TRS CP/M SSDD Format Disks
 This is available from Sage for \$36.95 (SEE SHOPPER SECTION)

3. INFO - When purchasing CP/M software, be sure you get CP/M 80 VERSION 2.2 This is what you need to run on ADAM.

4. SOURCE - Many BB's and ONLINE services offer CP/M software free to download. Below is a list of some recent programs found on COMPUSERVE just waiting to be downloaded.

ZBOCHE.DOC	TELL.COM	XMODEM.TCH
CHECKS.COM	MEXOVL.HEX	EDFILE.LBR
SC.COM	SO.COM	EDIT11.LBR
CV2COR.LBR	DIRR7.LBR	MEX114.COM
CV2EXM.LBR	GANESA.COM	UPLOAD.HLP
EGUTL.LBR	MEX.DOC	HL0AD.COM
BASEBA.COM	SD.COM	NLU11.COM
DSKRST.COM	LRUN.COM	XMODEM.DOC
EBASIC.LBR	JOB.COM	CPH.HLP
INVENT.COM	AREACO.COM	VDE.COM
MDM740.LBR	BOOT.DOC	ZBOMR.COM
NSWP20.COM	DUU.COM	BUGS.COM
NSWP20.LBR	FILT7.COM	PCDS.LQR
DSKRST.ASM	NPIP.COM	COMMAN.LQR
ZBOCHE.COM	NLU15.LBR	PASCAL.LQR
DIRR7.COM	SDCPY.COM	PASCDO.LQR
	SDCPY.DOC	README.LST

5. SOURCE - Many of the major User Groups such as NIAD, Exapandable Computer News, & Rugment, offer CP/M public domain packs at reasonable costs. Send a SASE to these requesting their latest list.

6. SOURCE - PUBLICATIONS....There are many helpful CP/M publications available. SEE OUR PUBLICATION SECTION FOR A LARGE LIST OF CP/M BOOKS & PUBLICATIONS.



Adam Public Domain Software

If you're looking for software at little or no cost, Public Domain is the way to go. There is becoming an ever-growing collection of Public Domain Software for the ADAM. This is software that is not copyrighted therefore making it permissible to copy. It is often offered by various sources at a minimal cost to cover materials & service.

THE ADAM RESOURCE recommends doing the following if you wish to build a strong library of this software:

- 1. CONTACT USER GROUPS** - Go through our user group section & check-out the groups that have P.D. packages. Send for their latest listing by sending an SASE. Below we have listed a few major sources but there are others. Many groups are willing to trade to build their library.
- 2. USE YOUR MODEM** - A lot of free software is available "ONLINE" Check-out our ONLINE SECTION for sources.
- 3. READ BOOKS** - We suggest checking out the books at your local library. There are many books devoted to P.D. Software written in BASIC. Many of these programs will run with little or no changes. Particularly Apple Soft programs, providing there are no POKES or PEEKS. (Note: See our HACKER SECTION)
- 4. ALTER PROGRAMS** - There are a lot of good programs just sitting in books, however, many need some changes to run on ADAM. (We have included in our HACKER SECTION a special chart on APPLE-ADAM conversions to assist you in converting APPLE programs with PEEKS & POKES to run on ADAM.)

HERE ARE A FEW SOURCES FOR FOR P.D. SOFTWARE:
BE SURE TO CONTACT USER GROUPS. THIS IS THE BEST SOURCE FOR P.D. SOFTWARE. (Write to these sending an SASE for their latest listing of P.D. Software. We have obtained lists from the following but have not listed them here because they are constantly being changed & updated. We feel you should write for the latest.)

- SAGE ENTERPRISES/Route 2 Box 211 Scribner Rd.,Russleville, MO 65874 (see shopper section)
- PUGET SOUND ADAM NETWORK/22607 SE 322nd, Kent, WA 98042
 - NIAD/P.O. BOX 1317, Lisle, IL 60532
- KANSAS AUG/ 1335 N. Meridian Apt 201, Wichita, KS 67203-4637
 - ADAM USER'S GROUP/P.O. BOX P, Lynbrook, NY 11563
- OUTSIDERS USER GROUP/Donald Villard, 122 Cedar Ln., Starkville, MS 39759
- GORDON MEYER/2600 W. 6000 South, Roy, UT 84067-(801)773-7766
- ELLIAM ASSOCIATES/24000 Benemer St.,Woodland Hills, CA 91367
- R.A. SOFTWARE/FREWARE/Brentwood Baptist Church, Gordon at Peacock, Charleston Heights, SC 29405
- THE HOLY CITY AUG/Dan Pease, 12 Buda Ave., Charleston SC 29405
 - DATACOM SUPER SYSTEM/ BBS (813)937-3600 or 937-6829
 - DALLAND EMPIRE COMPUTER GROUP BBS/Cotton, CA (714)797-4745



The Hardware Section

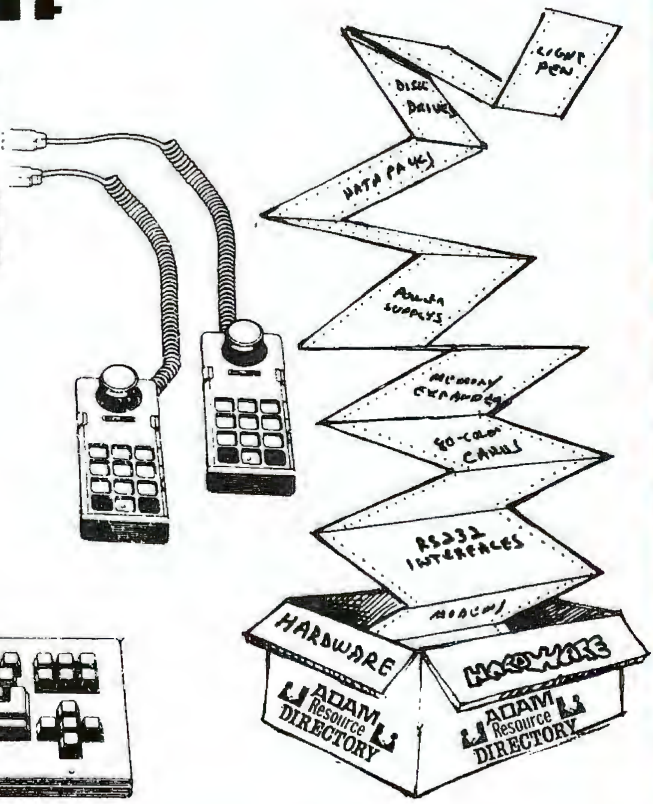
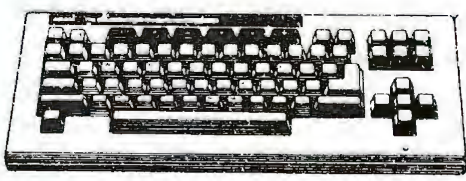
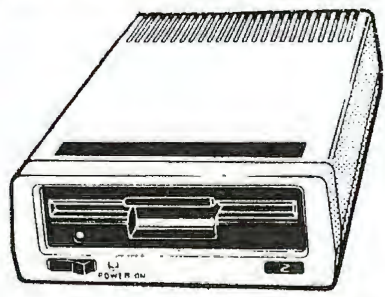
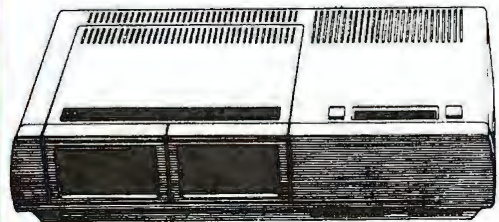

The greatest thing that could happen to ADAM has begun happening. Thanks to a few 3rd party companies, there is now an adequate selection of hardware available for ADAM. We encourage you to support these companies. The powers of ADAM are much greater because of the products on the following pages.

We have included a special "question & answer sheet" courtesy of Eve Electronics, on the following page for those of you who are not familiar with interfaces & what they do, etc...

A GREAT PORTION OF THIS BOOK WAS DONE USING PRODUCTS FROM EVE ELECTRONICS & ORPHANWARE. WITHOUT THESE, OUR TASK WOULD HAVE BEEN NEARLY IMPOSSIBLE. BE SURE TO CHECK-OUT THE SHOPPER SECTION FOR HARDWARE PRODUCTS.



EVE ELECTRONIC SYSTEMS
2 Vernon St., Suite 404
Framingham, MA 01701
(617) 653-3003

Because of the hundreds of requests for information on EVE Electronic Systems products and services, it is impossible to answer all responses individually. Therefore, this is a list of SOME of the commonly asked questions and answers on the EVE line of computer products for the Coloco ADAM Computer. In the near future Eve Electronics will establish a "computer" bulletin board service for question on the products for ADAM, and for placing orders. We will also maintain a mail list for future product announcements and information.

Q. What is the EVE SP-1 ?

A. The EVE SP-1 is an interface for the ADAM Computer to allow the use of printers, plotters, modems, etc. The SP-1 has both a parallel printer port, Centronics compatible, and a programmable RS-232C serial port.

Q. What printers can be used with the EVE SP-1 ?

A. Any printer with a Centronics standard parallel interface, or an RS232C interface may be used with the EVE SP-1.

Q. What printers do you suggest ?

A. There are literally hundreds of different printers on the market today, and that number is growing constantly. Virtually any dot matrix, ink-jet, or letter quality printer with either a Centronics type parallel or RS-232C interface will work with the EVE SP-1. The following is a list of a few brands and models which are currently being used by EVE SP-1 owners.

Panasonic - 1090, 1091, 1092	Star - 10X, 15X, Delta 10
Epson - MX-80, MX-100, RX-80, FX-100, LQ1500, LX-80, JX80	
Okidata - 82, 182, 84P, 84S, 193	Anadex - DP-9500, DP-9501
NEC - 5500 series, 7700 series, 3500 series, 8800 series	
Gorilla 'Banana'	Smith-Corona - Fastext 80
Diablo - 620, 630, 1620	Juki - 6100, 6300
Radio Shack - 'parallel printers'	Mannesmann Tally - MT-160L

This list is not complete. If you still have a question about another printer let us know, but most serial or parallel printers will work!

Q. What Plotters can be used ?

A. Just as with the printers, if the plotter has a Centronics type parallel or RS-232C serial interface it will operate with the EVE SP-1.

Q. Does the printer or plotter need special software ?

A. The software provided with the EVE SP-1 includes the 'drivers' for both SmartBasic, and CP/M. We also provide a 'patch' for the EOS operating system to allow printouts directly from SmartWriter and SmartFiler.

Q. Can I print files directly from SmartWriter ?

A. Yes, however, due to the unique codes sent to the ADAM printer, some feature will not work properly without a 'Custom Print Program' for the specific printer you have selected. These include underlining and super-and-sub-scripting.

Q. What is the 'CUSTOM SmartWriter Print Program'?

A. Because of the unique codes required by each different type of printer to perform such functions as 'super- and sub-scripts', 'italic', compressed, expanded, bold print, etc., a special version of the EOS patch program must be used which has been configured for the particular printer you are using. We feel we should not restrict you to using only a handful of different printers, but rather allow you to select the unit which best suits your needs and budget.

Q. Can I print files from SmartFiler ?

A. With the EOS PATCH now available you can print directly from SmartFiler.

Q. Can I print spreadsheets directly from ADAMCALC ?

A. No. AdamCalc, like several other 'special protected' programs contain their own printer drivers. Since these programs and their associated drivers were designed to 'prevent' modification, there is no way at this time to allow printouts thru the SP-1. Hopefully, with some cooperation from the software writers, this may be possible in the future.

Q. Can I print graphics with my printer and the SP-1 ?

A. If the printer you select has a graphics mode, or a graphics character set, graphics may be used by either 'your' programs, or with several graphics packages available for CP/M. The EVE SP-1 interface and 'driver' software will allow any 8 bit character to be sent to the printer. Therefore if 'your' program sends the proper sequence of commands to your printer, it will be able to print graphics. In addition several SP-1 users are developing programs for such functions as screen dumps in both monochrome and color for specific types of printers.

Q. Does the SP-1 or SS-CC require external power, ie. 120 VAC ?

A. No, the SP-1 and SS-CC are designed for very low power consumption, and therefore are able to derive the power they need from the ADAM system.

Q. Can I do business graphics ?

A. Yes. There are several excellent CP/M business graphics programs available. One example is 'GRAPH-TALK', which supports dozens of different printers. GRAPH-TALK will use your data files or keyboard entry to generate PIE CHARTS, BAR-Graphs, Line graphs in a variety of different formats.

Q. Are these programs available for ADAM's CP/M ?

- A. Yes. Virtually all CP/M 80 software will work on the ADAM CP/M system providing:
- 1 - There is adequate disk space on your ADAM disks.
 - 2 - The screen control codes are or may be configured for ADAM.
 - 3 - The program does not use unalterable 'hardware specific' I/O.

Q. Can I use an 'EXTERNAL' modem with the SP-1 ?

A. Yes. The EVE SP-1 may be used with most RS-232C interface modems, including the 'Smart modems', such as the Hayes, Anchor, etc. The only other requirement is a properly configured communications program.

Q. What Communications programs may be used ?

A. There are many excellent communications programs which operate under CP/M that can be configured to work with the EVE SP-1. Some of these programs are available in the public domain, and others may be purchased. Some of these include MITE, MITE+, ASCOM, MODEM7, MEX, LINK, etc. The program we recommend is the MITE package by Hycroft Labs. This is a very powerful, versatile, easy to use system which will allow file transfers in ASCII and several binary formats.

Q. Is software available to let ADAM work as a 'remote' computer ?

A. Yes. With the EVE SP-1, the MITE communications package, and an auto-answer modem, the ADAM may be set up for remote use. The Mite package has many special features such as password protection, and user privilege levels. There are also some 885 packages available which may be configured for use with the EVE SP-1.

Q. Can I use MITE with the ADAM Modem also ?

A. Yes. However, because the ADAM modem does not allow for 'auto-answer', the full features

and capabilities of the MITE program may not be used.

Q. What baud rates can I use with the SP-1 ?

A. The SP-1 will operate at any standard baud rate from 50 to 19,200 baud. The configuration program provided will allow easy selection of the more common rates. If another rate is desired, EVE Electronics will provide information on how this is done.

Q. Can I use the SP-1 to communicate with another computer ?

A. Yes. This may be done either with a modem over phone lines, or by direct connection to the other computers RS-232C port. It may be necessary to use the information in the SP-1 manual to make the proper connections. For further technical information contact EVE Electronics.

Q. Can the SP-1 be used with the Expansion Module #3 ?

A. Yes. All EVE Products may be used with the full system. With the Expansion Module #3, all may be used except the 80 column unit.

Q. What is the 80 column unit ?

A. The EVE YD-MB 80 Column / Mother-board unit will allow full screen display on all 80 columns under the CP/M operating system and SmartBasic as the PR#4 device. This unit will also contain 4 expansion slots for other EVE interfaces, and a power supply for ADAM. The YD-MB will connect to the ADAM console video output and pass output to a 'monochrome' or 'composite' color monitor.

Q. Will the 80 column unit work on a TV ?

A. No. The output of the YD-MB must be connected to a monochrome or good resolution color composite monitor.

Q. Will the 80 column unit work with Expansion Module #3 ?

A. No. The YD-MB requires the composite video signal from the ADAM console to operate properly. If your Expansion unit has been modified to provide composite output, it will work. EVE Electronics will have available a 'kit' to modify the game system to provide the necessary outputs for the YD-MB.

Q. What Software is usable / transferable to ADAM.

A. If you have ADAM CP/M, you can use almost any 'configurable' CP/M-80 program. EVE Electronics offers this transfer service. Contact us for further information.

Q. What is the SS-CC unit ?

A. The EVE SS-CC unit is a Speech synthesizer / real-time clock-calendar interface for the ADAM. It will allow you to create programs to let ADAM 'talk', or you may modify your existing programs. The unit also contains a clock-calendar circuit which may also be used by your programs to allow ADAM to know exactly what time and day it is. The clock-calendar is 'battery backed-up' to retain the time/date information even while ADAM is off for several days or weeks.

Q. Will the Speech synthesizer work in SmartBasic and under CP/M ?

A. Yes. Sample programs and information on the phoneme library are provided with the unit. Other optional speech programs will be offered as they become available.

Q. Can I use the SS-CC and the SP-1 at the same time ?

A. Yes. Eve Electronics offers the MU-2, and MU-3 multi unit cables to allow use of 2 or 3 Eve products simultaneously. Therefore, you can use the MU-2, the SP-1 and the SS-CC. With the MU-3 you can use the SP-1, the SS-CC, and the DC-1 disk controller, when available. Also, the YD-MB 80 column / mother-board unit will allow 4 EVE units to be installed.

Q. What will the 'disk controller' do ?

A. The EVE DC-1 disk controller unit will allow the connection of most commonly available generic disk drives to the ADAM under the CP/M operating system. You will be able to use 3.5", 5.25", and 8" drives, single or double sided, single and double density, with up to 255 tracks. This will give ADAM the capacity for storage of literally 'mega-bytes' of disk storage. This unit will only be supported under CP/M, and will support optional programs to transfer files from several other system disk formats.

Q. What is the ME-64 memory expansion unit ?

A. The EVE ME-64 is a 64 k memory expansion unit which is functionally compatible with the Coloco Memory Expander. This unit plugs in the ADAM memory console, and will be required for some of the software available from EVE Electronics.

Q. Does the ME-64 provide extra memory for SmartBasic ?

A. SmartBasic 1.0 does not support additional 'program' space using the memory expansion unit, however, SmartBasic 2.0 does.

Q. Do you give dealer or club discounts ?

A. EVE Electronics offers dealer discounts for quantity orders of units of the same type. Contact EVE Electronics for further information.

Q. Do you sell games ?

A. No, we primarily handle hardware and CP/M business related software. We do however maintain a list of other dealers who handle 'games'.

Q. Can the SP-1 and SS-CC be plugged into the MON-80 ?

A. No. The MON-80 unlike the YD-MB, does not contain expansion connectors. You may use the MU-2 or MU-3 to utilize more than one EVE product at a time.

Q. Will the MON-80 be able to provide power to ADAM ?

A. No. The MON-80 will not have a power supply for ADAM. You may use the PS-1 for this purpose if desired.

Q. Will the MON-80 have a lite pen input ?

A. No. No provision for lite pen is provided on the MON-80.

Q. Will my PS-1 be obsolete when I get the YD-MB ?

A. The YD-MB contains a power source for ADAM. If you already have the PS-1 we will allow a trade-in allowance based on age and condition of your PS-1.

Q. Will it be difficult to remove the SP-1 & SS-CC units from their boxes.

A. The YD-MB will provide the detailed instructions for removal of the EVE stand alone units such as the SS-CC and SP-1. For those units which require them, special connector brackets will be provided.

Q. Where may the YD-MB be placed when connected to ADAM ?

A. The YD-MB has been designed to be placed either directly on top of, or to the right of the Memory Console, and plugs into the Expansion port.

Q. Are programs available from other EVE product users ?

A. Yes. We encourage the development of software for use with EVE products, and will provide all information possible. If you have written any software for EVE products, please send it to us for review, and listing in our catalogs.

Q. Where can I get Public Domain CP/M software ?

A. Public domain software is available from many sources, including CompuServe, remote BBS systems, local Computer Societies, etc. In the future, EVE Electronics will have available a library of such public domain software.

Hardware

[] 2.2 Megabyte MEMORY UPGRADE—

AdamLand \$399.95

Supplied with 512K, upgradable to 2.2 MEG. On the same card with HARD DISK CONTROLLER & slot for disk. With installation software.

[] 25' ADAMNET CABLE—

Practical Programs \$10.95

Straight cable to go from keyboard or disk drive to memory console.

[] 300 BAUD MODEM—

Hi-Tek Research & Mark. \$80 US

300 baud modem for use with ADAM. Comes with software.

[] 64k MEMORY EXPANDER—

Orphanware \$44.95

Increases ADAM's memory to 144k. Can be used with Auto Aid, CP/M and any other software that uses the expanded memory capacity of the computer.

[] 64K MEMORY EXPANDER—

Adamland \$69.95

Installs in slot #3. Extends storage in Smartwriter & Basic. Allows printing in ADAMCALC while working on another part of spreadsheet.

[] 64K MEMORY EXPANDER—

Eve Electronics \$54.95

Eve ME-64 The same as the Coleco memory expander. Installs inside ADAM. Required to run some software.

[] 64k MEMORY EXPANSION—

Spectrum Electronics \$65 US

A duplicate of the Coleco version

[] 80 COLUMN VIDEO MONITOR—

Eve Electronics \$300

Eve MON-80 80 Column Video board and monochrome monitor assembly. Includes cable to attach to inside of ADAM console. Does not independent power supply or motherboard. Includes Word Processing & Basic software programs.

[] 80 COLUMN VIDEO UNIT/ MOTHER BOARD ASSEMBLY—

Eve Electronics \$300.00

Eve VD-MB 80 gives ADAM full 80-column capabilities. You will actually see 80-columns on the screen. This unit has been designed to give ADAM the screen characteristics of the industry standard VT-52 terminal. (Price varies depending on whether you get it with or without a power supply.) Includes expansion slots to attach other Eve products. Light Pen port included. Includes Word Processing & Basic software programs.

[] ADAM CPU BOARDS—

American Design \$9.95

The two boards (guts) that make ADAM ADAM, are available for \$9.95 each. You can also purchase everything you need to build an ADAM less the printer for under \$100. See our ADAM KIT article.

[] ADAM POWER SUPPLY—

\$14.95

Several Companies offer the original ADAM power supply that's in the ADAM printer. No cover. You need to build your own box. They do work with a slight adjustment. See our article on the ADAM KIT for details. Also check-out the retailers list for suppliers.

[] ADAM PRINTER BUFFER—

AdamLand \$179.95

Allows you do dump up to 42 pages of text or graphics into the buffer, freeing the computer to do other work while the printer does its. Can be used series or parallel. Copy feature, LEDs, etc... Comes with 64k. Can be upgraded to 256k or 512k

[] ADAM REPLACEMENT RIBBON—

\$6.95

Available from most dealers. Color also available.

[] ADAM RESOLUTION ENHANCER—

AdamLand \$79.95

Improves the readability of text, graphics & colors. Removes blurs, smears, white outlines etc. Includes 'gold-end' cable.

Hardware

[] ADAM/IBM EMULATOR-

AdamLand ?

Will run some IBM software on ADAM such as Symphony, Jazz, Lotud 1-2-3 Write for price & further details.

[] ADAM link DIRECT CONNECTION MODEM-

Coleco \$60-\$99

Must be purchased from 3rd party retailer, not Coleco.

[] C-INTERFACE-

Capital Software \$69.95

A single circuit board that fits inside ADAM in expansion slot #1. It adds a Commodore 64 Serial Bus Interface to ADAM. This allows you to connect many high speed printers to ADAM. Software is included. Note: Capital has special price combinations when purchasing a printer with the C-Interface.

[] CARD EDGE ADAPTER-

Eve Electronics \$14.95

For use with multi-unit adapter cables. Allows devices such as the Coleco digital dialer unit to be connected with Eve interfaces installed. Eve CER-1

[] CENTRONICS PRINTER INTERFACE.-

Orphanware \$60

Allows the use of a high-speed printer with ADAM. Comes with support software for SmartBasic, Smartwriter & CP/M.

[] CLOCL-CALENDAR-DATE IMPRINTER-

AdamLand \$119.95

Puts time & date on Screen or paper. Keeps on-line time. Experience necessary to install.

[] COLECOVISION CONTROLLERS-

Coleco \$4.95-\$20

Several companies offer controllers (joy stick) SEE RETAILERS SECTION.

[] COLECOVISION/ADAM ROLLER CONTROLLER-

Available from 3rd party companies. Price varies.

[] COLECOVISION/ADAM SUPER ACTION CONTROLLER

Coleco

Available from 3rd party companies.

[] CUSTOM SERIAL CABLE ASSEMBLY-

Eve Electronics \$20.00

For use with the Eve SP-1 when connecting ADAM to a non-standard modem or serial printer.

[] DAISYWHEELS-

\$5.95

Various styles available from many companies. See sample types in this section.

[] DATA DRIVES-

\$9.95-\$35

Data drives are available from several companies & user groups with buying services at discount prices. See the retailers section for the dealers that carry such.

[] DATA-PACKS-

\$2-\$8

Many companies offer Datapacks at a discount price. Coleco packs & Loranger Packs are the same. There are other good ones available also. See our ADAM SHOPPER SECTION.

[] DISK DRIVE SYSTEM-

Eve Electronics

Eve DC-1A/SS This is a single sided disk drive unit, functionally equivalent to the Coleco Disk Drives.

[] DOUBLE-SIDE DISK DRIVE-

Eve Electronics

Eve DC-1A/DS This is a double-sided disk drive system allowing 320 K of DISK storage PER DRIVE. Call for price. To have your present drive upgraded, cost is \$149.95

[] DUST COVER SETS-

Data Backup

Available for memory console, printer & keyboard.

[] EXPANSION MODULE #1-

Coleco \$39

Allows you to play Atari 2600 games on ADAM. Coleco does not carry anymore. Must be purchased from 3rd party.

[] EXPANSION MODULE #2-

Coleco \$30

This is the driving module. Must be purchased through 3rd party, not Coleco.

Hardware

[] FRONT MOUNT SWITCH & PRINTER LEG SET-

Data Backup \$16

Legs raise ADAM 3 3/4 inches to allow fanfold paper to be placed underneath. Switch eliminates having to have to switch ADAM off & on from the back. (Price for just switch \$11)

[] KEYBOARDS-

\$9.95-\$20

Several companies offer ADAM keyboards with & without covers. See the retailers listing for sources.

[] LIGHT PEN-

AdamLand \$89.95

Paint, graphics, quick selector, eraser, possibilities unlimited, with interface, software & instruction.

[] MODULE #3 CONVERSION KIT-

Eve Electronics \$29.95

Eve-EXP-MOD This kit allows expansion module owners to modify the game machine to provide audio & composite video output for use with the VD-MB, MON-80 & composit monitors. (This must be installed by a skilled technician. (Ad \$10 to price for installation)

[] MONITOR CABLE-

Data Back-up \$9

Audio/video cable for standard ADAM monitor output.

[] MULTI-UNIT ADAPTER CABLE-

Eve Electronics \$34.95

Eve MU-2 Allows the use of two hardware units to be connected to ADAM at the same time without switching cables. (example: the SP-1 and the SS-CC can be hooked at the same time.)

[] MULTI-UNIT ADAPTER CABLE-

Eve Electronics \$44.95

Eve MU-3 Allows use of three hardware units to be plugged into ADAM at the same time without switching cables.

[] NULL MODEM ADAPTER-

Eve Electronics \$15.95

Eve NMC-1 For use with the Eve SP-1 when interconnecting with other computers & some printers & modems

[] NUMERIC KEYPADS-

AdamLand \$49.95

New numeric keypads adapted for ADAM. Must be installed on your keyboard & game controller holder by the manufacturer.

[] PARALLEL PRINTER INTERFACE-

Eve Electronics \$79.95

Eve SP-1P This is the Parallel only version of the Serial/parallel interface. Allows the use of a parallel printer with ADAM.

[] POWER PACK-

Eve Electronics \$69.95

Replaces ADAM printer power supply. Allows use of ADAM without the ADAM printer & provides power for other hardware products.

[] POWER SUPPLY-

Adamland \$69.95

Replaces Adam's which is contained in the printer. This is an external unit. Easy hook-up.

[] POWER SUPPLY-

Eve Electronics \$79.95

Eve PS-1A This is a heavy duty version of the standard Eve unit. It is intended to be used in applications where Data Drives are frequently used.

[] RS232 INTERFACE-

HiTeck Research & Mark. \$105.99 US

Serial & Parallel interface for ADAM. Allows connection of printers, modems, etc.. to the ADAM system.

[] RS232 PARALLEL INTERFACE-

Hi-Teck Research & Mark. \$40 US

Parallel only interface for parallel printers to be hook-up to ADAM.

[] SERIAL CABLE ASSEMBLY-

Eve Electronics \$16.00

Eve SER-1 For use with the Eve-SP-1 when connecting to a modem or serial printer.

Hardware

[] SERIAL/PARALLEL INTERFACE-

Eve Electronics \$139.00

SP-1 Includes an RS-232C Serial channel, & a Centronics Parallel printer channel. Allows use of hundreds of printers. Software for use with SmartBasic, Smartwriter, & CP/M. Includes a choice of either Serial or Parallel cable.

[] SPEECH SYNTHESIZER/CLOCK CALENDAR-

Eve Electronics \$109.95

Eve SS-CC Allows ADAM to actually talk. Software includes a standard phoneme library, and sample 'talk' & 'Clock' programs. Includes a time clock circuit. For use with SmartBasic & CP/M.

[] SUPER DISK DRIVE-

AdamLand \$599

BOOK per disk, 1.6 Megabyte total. Low slimline cabinet. Built in surge suppressors. Self-contained power supply. Includes info & installation software.

[] SUPER TALK VOICE SYNTHESIZER-

Marathon Computer Press

Teach ADAM to talk. Integrates with Smartbasic, Logo & CP/M. Plugs into expansion slot #2 Kit & Manual is \$59.95 Fully assembled, tested, with software, \$99.95 (Optional demo tape available \$15.75)

[] TRACTOR FEED-

Data Backup \$79

Allows use of pifold paper without "bushing". Includes 4 blank data-packs & a program tape of Banner maker. Allows you to make signs on fan-fold paper.

[] VIDEO/AUDIO CABLE ASSEMBLY-

Eve Electronics \$16.00

Audio cable needed to hook ADAM up to a monitor. ADAM uses a DIN plug.

[] VOICE SYNTHESIZER-

AAL Computing \$49.95

Complete kit to make your ADAM talk. Features natural speech & unlimited vocabulary. Requires a moderate level of construction skill to complete. (32-page manual available separate for \$9.95)

Here are several examples of Daiseywheels available for the ADAM. The average price is about \$5.95 each. (this list courtesy of M.W.Ruth Company)

PICA 10 (This comes with ADAM
 \1234567890-+^ qwertyuiop[] asdfghjkl;' zxcvbnm,./
 !@#%&_*()=- QWERTYUIOP{} ASDFGHJKL:" ZXCVBNM<>?

PRESTIGUE PICA 10
 |1234567890-+^ qwertyuiop[] asdfghjkl;' zxcvbnm,./
 @!@#%&_*()=- QWERTYUIOP{} ASDFGHJKL:" ZXCVBNM<>?

ELITE
 \1234567890-+^ qwertyuiop[] asdfghjkl;' zxcvbnm,./
 !@#%&_*()=- QWERTYUIOP{} ASDFGHJKL:" ZXCVBNM<>?

PRESTIGE ELITE
 \1234567890-+^ qwertyuiop[] asdfghjkl;' zxcvbnm,./
 !@#%&_*()=- QWERTYUIOP{} ASDFGHJKL:" ZXCVBNM<>?

COURIER 10
 \1234567890-+^ qwertyuiop[] asdfghjkl;' zxcvbnm,./
 !@#%&_*()=- QWERTYUIOP{} ASDFGHJKL:" ZXCVBNM<>?

COURIER 72
 \1234567890-+^ qwertyuiop[] asdfghjkl;' zxcvbnm,./
 !@#%&_*()=- QWERTYUIOP{} ASDFGHJKL:" ZXCVBNM<>?

LETTER GOTHIC
 \1234567890-+^ qwertyuiop[] asdfghjkl;' zxcvbnm,./
 !@#%&_*()=- QWERTYUIOP{} ASDFGHJKL:" ZXCVBNM<>?

FORMS GOTHIC
 \1234567890-+^ qwertyuiop[] asdfghjkl;' zxcvbnm,./
 !@#%&_*()=- QWERTYUIOP{} ASDFGHJKL:" ZXCVBNM<>?

DUAL GOTHIC
 @1234567890-+^ qwertyuiop[] asdfghjkl;' zxcvbnm,./
 !@#%&_*()=- QWERTYUIOP{} ASDFGHJKL:" ZXCVBNM<>?

EMPHASIS
 \1234567890-+^ qwertyuiop[] asdfghjkl;' zxcvbnm,./
 !@#%&_*()=- QWERTYUIOP{} ASDFGHJKL:" ZXCVBNM<>?

BOOKFACE ACADEMIC 10
 @1234567890-+^ qwertyuiop[] asdfghjkl;' zxcvbnm,./
 !@#%&_*()=- QWERTYUIOP{} ASDFGHJKL:" ZXCVBNM<>?

SCRIPT
 @1234567890-+^ qwertyuiop[] asdfghjkl;' zxcvbnm,./
 !@#%&_*()=- QWERTYUIOP{} ASDFGHJKL:" ZXCVBNM<>?

ITALIC
 @1234567890-+^ qwertyuiop[] asdfghjkl;' zxcvbnm,./
 !@#%&_*()=- QWERTYUIOP{} ASDFGHJKL:" ZXCVBNM<>?



Hardware

The ADAM Resource

Publication Section

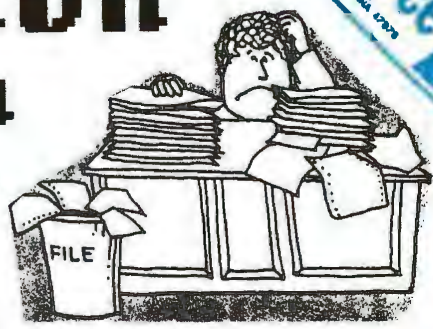
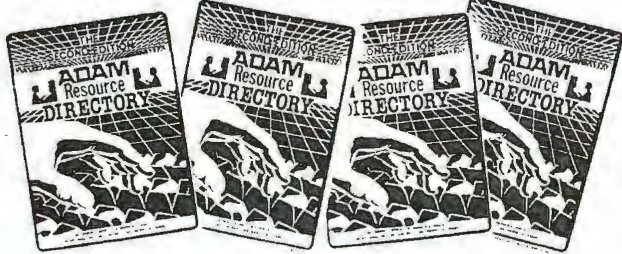

Here's what you'll find in this section:

Adam Books

ALMOST 50 BOOKS SPECIFICALLY FOR ADAM ARE LISTED

Adam Publications

MONTHLY & BI-MONTHLY NEWSLETTERS SPECIFICALLY FOR ADAM

General Computer Mags

70 COMPUTER MAGS & JOURNALS LISTED.

CP/M Publications

EXCELLENT RESOURCES FOR THOSE INTERESTED IN CP/M

Z-80 Books

A GOOD NUMBER OF BOOKS FOR THE SERIOUS ADAM PROGRAMMER WHO WANTS TO USE MACHINE LANGUAGE. THESE BOOKS WILL GET YOU GOING

SEE OUR "ONLINE" SECTION FOR ONLINE BOOKS



Publications
Publications
Publications
Publications
Publications



ADAM BOOKS

Here you will find a very complete listing of ADAM-ONLY computer books that have been published. Where possible, we have included a special "ISBN" number. This number is used by dealers to better locate books. Use this number when you want to order something from your local bookstore. It will speed things up.

[] 1ST BOOK OF ADAM (SMART BASIC)—QUE/10.95/

[] 2ND BOOK OF ADAM (SMART WRITER)—QUE/8.95/

[] 32 BASIC PROGRAMS FOR THE ADAM—DILITHIUM PR
ESS/36.00/4 DATA PACKS
INCLUDED.

[] A HACKER'S GUIDE TO ADAM—PETER & BEN HINKLE/12.95
/ADD 5.00 FOR TAPE
WITH PROGRAMS ALREADY ON IT. EXCELLENT TECHNICAL SOURCE FOR ADAM.

[] ADAM HOME COMPUTER: AN INTRO TO BASIC
& APP—Brady Comm./12.95/1985
Larry Goldstein (ISBN 0-89303-296-4)

[] ADAM USERS GUIDE —BRADY/15.95/

[] ADAM'S COMPANION —Avon/9.95/Ramsey Benson & Jack Rochest
er, 1984 (ISBN
0-380-87650-7) Advanced programming & sound routines. Be sure to purchase the
revised edition.

[] ADAM'S COMPANION —AVON BOOKS/9.95/FOR ADVANCED APPLICAT
IONS IN
PROGRAMMING. BE SURE TO GET THE REVISED EDITION. BY BENSON & ROCHESTER.

[] ADAM: AN INTRO TO THE OPERATING, BASIC
ETC—BRADY/17.95/ADAM: AN
INTRODUCTION TO THE OPERATING, BASIC PROGRAMMING, AND APPLICATIONS is
full title

[] ADAM: THE HOME COMPUTING SYSTEM—Banbury Bks.
/14.95/Eric Berg & Alan
Smith, 1984 (ISBN 0-88693-066-9)

[] BASIC ADAM —Wiley/14.95/William Abikoff & Gary Cornell. (ISBN 0
-471-
80807-5)

[] BASIC BASIC PROGRAMS FOR THE ADAM—TAB/12
.95/paperback available for 8.
25 (ISBN 0-8306-0716-1)

[] CAN I PLAY WITH THE COMPUTER TOO?—Banbur
y/14.95/

[] CASSETTE TO DATA PACK CONVERSION MANU
EL—Dominguez/19.95/includes
sample datapack, cost for manuel only 15.95 , R.B. Dominguez, 1985, Instructions
on how to succesfully make your own datapacks.

[] COLECO ADAM —Bams/9.95/David Disthimer & Ted Buchhoiz. (ISBN
0-672-
22312-0)

[] COLECO ADAM BASIC —Osborne-McGraw/10.95/Richard Haskell
, 1985 (ISBN 0-
13-140450-4)

PUBLICATIONS

ADAM Books cont.

- [] COLECO ADAM ENTERTAINER —OSBORN/MCGRAW HILL/12.95
- [] COLECO ADAM FOR STUDENTS —Weber Systems/13.95/student edition
published, parent-teacher edition cancelled, 1984 (ISBN 0-938862-43-X)
- [] COLECO ADAM STARTER BOOK—Sams/16.95/Christopher Titus & Jonahon Titus,
(ISBN 0-672-22380-5,22380)
- [] COLECO ADAM USER'S ENCYCLOPEDIA—Bk. Co./14.95/(ISBN 0-317-05838-X)
- [] COLECO ADAM USER'S HANDBOOK—Weber Systems/9.95/staff, 1984 (ISBN 0-345
31839-0)
- [] COMPUSERVE STARTER KIT —COMPUSERVE/24.00/5 FREE HOURS OF CONNECT TIME
WITH PERSONAL ID NUMBER AND PASSWORD. MODEM REQUIRED.
- [] DISCOVERING SCIENCE ON YOUR ADAM—TAB/15.95/9.95 paperback, Talcott
Mountain Science Center, (ISBN 0-8306-1780-9,1780)
- [] EASY GUIDE TO YOUR COLECO ADAM—SYBEX/9.95/Thomas Blackadar, (ISBN 0-
89588-181-0)
- [] FIRST BOOK OF ADAM THE COMPUTER—TAB/14.95/9.95 paperback, (ISBN 0-8306
170-5)
- [] FLIPTRACK LEARNING SYSTEM—LEARNING EXPRESS/24.95/INCLUDES 2 SPOKEN
VOICECASSETTS AND QUICK REFERENCE GUIDE.
- [] HOW TO DOCUMENT YOUR SOFTWARE—TAB BOOKS INC.//BY BARBARA SPEAR—THIS
BOOK WAS WRITTEN USING AN ADAM COMPUTER.—BLUE RIDGE SUMMIT, PA 17214
- [] HOW TO USE THE ADAM —Flip Track/29.95/Donald Zochert Ed. by Janice
Rinehart, 1984, includes workbook & tapes. (ISBN 0-318-01203-0)
- [] HOW TO USE THE COLECO ADAM—Dilithium Press/5.95/Jerry Willis, 1984
(ISBN 0-88056-149-1)
- [] HOW TO USE THE COLECO ADAM—DILITHIUM PRESS/5.95/
- [] JOY OF BASIC FOR THE ADAM—BRADY/14.95/
- [] KEN USTEN'S ILLUSTRATED GUIDE TO THE ADAM—P-H/12.95/Ken Uston, 1984,
(ISBN 0-13-514647-X)
- [] L.O.F. COMMUNICATIONS —L.O.F. York, Pa./\$7.95/ADAM DIGITAL DATA PACK
FORMAT AND DUPLICATION MANUAL.
- [] LEARNING TOGETHER WITH ADAM—/9.95/HOW TO USE THE COMPUTER TO EDUCATE
CHILDREN. COVERS SMARTWRITER, BASIC, AND SMARTLOGO.
- [] LEARNING TOGETHER WITH ADAM—McGraw/9.95/Peter Scharf, 1985, (ISBN 0-07
055169-3)

ADAM Books cont.

[] MASTERING THE COLECO- VISION ADAM-NAL/12
.95/Kent Porter, 1984, (ISBN 0
452-25488-4,plume)

[] PRACTICAL ADAM:A FAMILY GUIDE BOOK-Rest
on/14.95/Robert Wolenik, (ISBN
0-8359-5583-4)

[] PROGRAMMING ADAM:HOME APPLICATIONS IN
BASC-BANBURY/11.95/

[] SMART BASIC FOR THE ADAM-BRADY/11.95/

[] THE ADAM HOME COMPUTER -BRADY COMMUNICATIONS/12.9
5/INTRODUCTION TO
SMARTBASIC AND APPLICATIONS.WRITTEN BY ARRY JOEL GOLDSTEIN

[] THINGS TO DO WITH YOUR COLECO ADAM CO
MPUTER-NAL/3.95/Jerry Willis,
1984, (ISBN 0-451-13182-7,Sig)

[] THIRTY-TWO BASIC PROGRAMS FOR ADAM-Dilli
thium/39.95/with datapacks, Tom
Rugg & Phil Feldman.,1984, cost 19.95 for just the book. (ISBN 0-88056-201-3)

[] USING & PROGRAMMING THE ADAM:-TAB/14.95/With
ready-to-run prigrams,
Timothy Knight, 1984, paperback is 7.95,(ISBN 0-8306-1706-X1706)

[] USING YOUR COLECO ADAM: BEGINNING BAS
IC & AP-P-H/11.95/Richard Swadley
& Joseph Wikert, 1985, cost including tape 24.95, (ISBN 0-13-939018-9)

[] WORD PROCESSING WITH YOUR COLECO ADAM
-SYBEX/9.95/Carole Alden, 1984,
(ISBN 0-89588-182-9)

[] WORD PROCESSING WITH YOUR ADAM-TAB/15.95/9.
25 paperback, (ISBN 0-8306-
1766-3,1766)

Publications

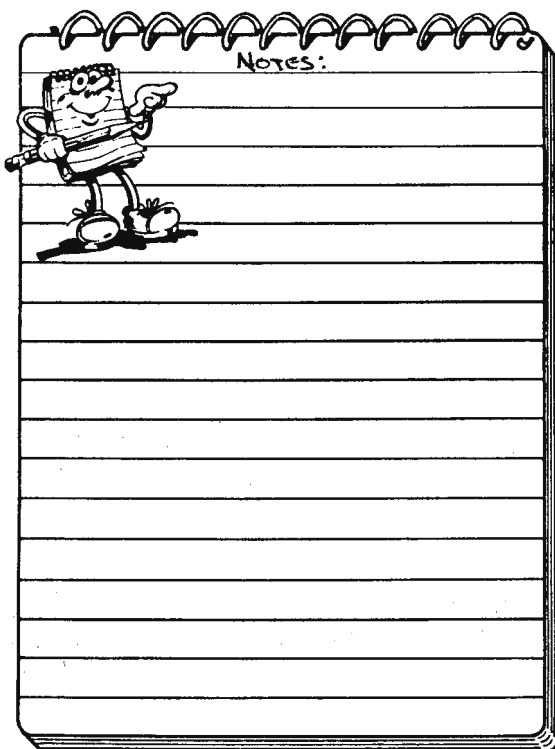

....LEARN MORE ABOUT ADAM....
READ! READ! READ! READ!



ADAM Publications

Here is a listing of published material for the ADAM other than books. These are in the form of monthly & bi-monthly newsletters. Every ADAM owner should subscribe to at least one or two of these type publications. It's the best way to stay in contact with the rest of the ADAM world throughout the year.

[] AUGMENT —ADAM USER' GROUP/\$12/yr/BiMONTHLY NEWSLETTER OF THE 'ADAM USERS' GROUP' (A NATIONAL GROUP) APPROX. CIRCULATION 5000(SEE AD-SECTION FOR DETAILS)

[] COMPUTER ENTERTAINER —COMPUTER ENTERTAINER/\$30/yr/MONTHLY REVIEW NEWSLETTER.(INDEPENDENT)COVERS SEVERAL COMPUTERS,INCLUDING ADAM EVERY MONTH. COMPUTER ENTERTAINER,PO BOX 4702,N.HOLLYWOOD,CA 91607

[] EXPANDABLE COMPUTER NEWS —SAGE ENTERPRISES/\$15/yr/Bi-Monthly independent newsletter for ADAM owners.(SEE AD-SECTION FOR DETAILS)Excellent value for the serious ADAM owner.

[] FAMILY COMPUTING MAGAZINE—/\$16/yr/P.O.BOX 2512,Boulder,CO 80321 (carries ADAM programs as well as a number of ADAM ads in the Classifieds & "Direct Access" sections.

[] INLAND EMPIRE ADAM USER GROUP NEWSLETTER—INLAND EMPIRE USER GROUP/? /MONTHLY NEWSLETTER.CONTACT MIKE & PAULA SMITH,6644 SEINE AVE,HIGHLAND, CA 92346

[] NIAD —NIAD USER GROUP/\$18/yr/One of the few MONTHLY ADAM-Only publications available. See SHOPPER Section for more details onNIAD.We recommend this publication highly.

[] NIBBLES & BITS —Digital Express//Monthly newsletter for ADAM.(NEW) 18.00/year subscription
DIGITAL EXPRESS INC./1203 Northwoods Dr./Kings Mountain, NC 28086

[] SPRITE CHASER —#1 ADAM USERS' GROUP/\$15/yr/NEWSLETTER OF #1 ADAM USERS' GROUP (NATIONAL GROUP) WRITE:#1 ADAM USERS' GROUP.PO BOX 3761-ATT. JAY FORMAN,CHERRY HILL, NJ 08034(SEE-AD-SECTION)

[] SYNTAX —1st CANADIAN AUG//BiMONTHLY PUBLICATION OFTHE FIRST CANADIAN ADAM USERS' GROUP.—P.O.BOX 547 VICTORIA STATION,CANADA H3Z 2Y6.

[] W/PUG —Word Processing User Gr./15.00/Written by the people who publish AUGMENT.

[] ADAMLAND NEWS —AdamLand//Monthly publication by Buck Rodgers. Adamland is heavy into new hardware for the ADAM.(SEE SHOPPER SECTION

Publications

General Computer Magazines

There are a lot more Computer Mags & Journals out there than most people realize. When we researched this area, we were amazed & decided to include this listing of magazines & journals that some ADAM owners may be interested in. Even though these are not specifically ADAM mags, there is a lot of good learning that can be applied to the ADAM. You won't find most of these on your local newstand...so read through & enjoy!

B B S Directory. Ed. Christopher Fisher. 1983. 4 per yr. \$14. Box 4150, Beach Sta., Vero Beach, FL 32964. Tel.: 305-466-5515. *Directory of bulletin board services in North America. Each issue has listings arranged by state, area code and by type of computer. A comment line describes each entry by computer, interests, program downloading, hours of operation and if a fee is required for access.*

Beginners Guide to Personal Computers. Ed. Robert Elliott Purser. 1983. quarterly. \$48. circ. 1,000. Robert Purser Publications, Box 466, El Dorado, CA 95623-0466. *For the novice seeking information on how to buy a computer for home or business use. Information ranges from the basic reasons why one should buy a computer to which ones to buy for specific applications. Coverage also includes book reviews and articles on computer programming. No advertising is included.*

Classroom Computer Learning: the leading magazine of electronic education. Ed. Holly Brady. (Formerly (until 1983): Classroom Computer News). 1980. monthly. \$22.50. circ. 73,162. Pitman Learning, Inc., Learning Periodicals Group, 19 Davis Dr., Belmont, CA 94002. Tel.: 415-592-7810. *For pre-college educators. Feature articles on educational uses of computers in the classroom. Each issue has separate sections for elementary, middle and high school applications. Also contains news briefs, educational software reviews and new product information. Advertising is included.*

Closing the Gap. Eds. Dolores Hagen & Budd Hagen. 1982. 6 per yr. \$18. circ. 10,000. Random Graphics, Box 68, Henderson, MN 56044. Tel.: 612-248-3294. *For teachers of the disabled and those interested in the use of microcomputers in special education. Directed at both beginning and advanced computer users. Each issue contains information emphasizing the practical applications of microcomputers as personal tools and educational aids for the handicapped. May occasionally cover robotics applications. Hardware and software reviews regularly featured. Advertising is included.*

CoED Journal. Ed. Robert Demoyer. (Formerly: A S E E Computers in Education Division. Newsletter). 1969. every 2 months. \$15 to individuals; institutions \$45. circ. 1,250. American Society for Engineering Education, Computers in Education Division, Locked Box 68, Port Royal, VA 22535.

Collegiate Microcomputer. Ed. Brian J. Winkel. 1983. quarterly. \$28. Allen Press, Inc., Box 368, Lawrence, KS 66044. Tel.: 913-843-1234. Alternate address: Rose-Hulman Institute of Technology. 2706 Wilson Dr., Terre Haute, IN 47803. *A journal for collegiate personnel interested in microcomputers. Articles focus on applications for teaching and research in the classroom, laboratory and library as well as administrative offices. Occasionaly contains reviews of hardware, software and peripherals. Advertising is included.*

Compute! the leading magazine of home, educational, and recreational computing. Ed. Tom A. Halfhill. (Incorporating (as of 1982): Home and Educational Computing). 1979. monthly. \$2.95 per no. circ. 350,000. Compute! Publications, Inc., 324 W. Wendover Ave., Ste. 200, Greensboro, NC 27408. Tel.: 919-275-9809. Subscr. to: Box 914, Farmingdale, NY 11737. Tel.: 800-334-0868. *For users of Apple, Atari, Commodore 64, OSI, PET/CBM, Radio Shack Color, Texas Instruments, Timex Sinclair and Vic-20. Features articles and computer programs for home, educational, business and scientific use. Regular columns include software reviews, readers' letters, beginners' questions-and-answers, explanations of machine languages and notes for typing in featured programs. Advertising is included.*

Computer Advertiser. Ed. Jack Hoffpauir. monthly. \$18. Impressions Publishing Co., Box 3218, Boise, ID 83703-3218. Tel.: 800-551-7978.

Computer Age - Software Digest see Software Industry Report

Computer & Electronics Marketing. Ed. Ronald A. Karjian. monthly. circ. 14,866. Morgan-Grampian Publishing Co. (Boston), 1050 Commonwealth Ave., Boston, MA 02215. Tel.: 617-232-5470.

Computer & Software News. Ed. Charles J. Humphrey. 1983. weekly. \$24. circ. 30,000. Lebharr-Friedman, Inc., 425 Park Ave., New York, NY 10022. Tel.: 212-371-9400.

Computer Book Review. Ed. Carlene Char. 1983. 7 per yr. \$18. Comber Press, 735 Ekekelo Pl., Honolulu, HI 96817. Tel.: 808-595-7337. *Offers critical reviews of computer-related books and publications. Regular columns contain new title listings and publishing news. Advertising is included.*

Computer Entertainer. Ed. Celeste Dolan. (Formerly: Video Game Update & Computer Entertainer). 1982. monthly. \$24. circ. 7,200. 12115 Magnolia, Ste. 126, N. Hollywood, CA 91607. Tel.: 213-761-1561.

Computer Entrepreneur. monthly. \$36. Computer Entrepreneur Publishing Co., Box 456, Grand Central Station, New York, NY 10163.

Computer Games. Ed. Dan Gutman. (Formerly: Computer Games/Video Games Player). 1982. every 2 months. \$2.95 per no. circ. 135,000. Carnegie Publications, 888 7th Ave., New York, NY 10106. *For computer game enthusiasts. Provides current information on computer games, products and software. Regular columns include letters, a buyer's guide and software reviews. Advertising is included.*

Computer Graphics Today. Ed. Robert Cramblitt. 1984. monthly. \$12. circ. 25,000. Media Horizons, Inc., 475 Park Ave. S., New York, NY 10016. Tel.: 212 725 2300. *For members of the National Computer Graphics Association. Covers news events and product developments in the computer industry. Features editorials, interviews, a question-and-answer column and a calendar of events. Advertising is included.*

Computer Hot Line. weekly. \$59. Hot Line, Inc., Box 1373, Fort Dodge, IA 50501. Tel.: 800-247-2244. *For individuals and companies interested in buying and/or selling new and used computer equipment. Organized under headings including microcomputers, peripherals, software and word processing. Advertising is featured.*

Computer Language. Ed. Craig LaGrow. 1984. monthly. \$24.95. circ. 30,000. C.L. Publications, Inc., 131 Townsend St., San Francisco, CA 94107. Tel.: 415-957-9353.

Computer Living - New York. Ed. Bob Johnson. bi-w. \$18. Computer Journalism, Inc., 155 E. 23rd St., New York, NY 10010. Tel.: 212-505-2600. *Newspaper for the New York Metropolitan Area computer community. Feature articles and news briefs on the computer industry. Regular columns list bulletin board services and upcoming computer events. Advertising is included.*

Computer News of San Diego. Ed. Cindy Nelson. every 2 months. \$19.50. Singman Publications, Inc., 3945 Camino del Rio S., Ste. 304, San Diego, CA 92108. Tel.: 619-284-6000.

General Computer Mags- Cont.

Computer Products. Ed. Eileen Walsh. 1978. 10 per yr. circ. 100,325. Gordon Publications, Inc., 13 Emery Ave., Randolph, NJ 07869. Tel.: 201-361-9060. Subscr. to: Box 1592. Dover, NJ 07801-9947.

Computer Shopper: nationwide marketplace for computer equipment. Ed. Stan Veit. 1979. monthly. \$15. circ. 80,000. Patch Publishing Co., Inc., 407 S. Washington Ave., Box F, Titusville, FL 32780. Tel.: 305-269-3211. *For individuals and companies interested in buying, selling and using computer hardware, software and peripherals. Articles offer information on popular models of computers, software, new products, club news, network news and magazine reviews. Advertising is featured.*

Computer Update. Ed. Mary McCann. (Formerly Boston Computer Update). 1980. every 2 months. \$28 or membership. circ. 14,000. Boston Computer Society, Inc., One Center Plazo, Boston, MA 02108. Tel.: 617-367-8080. *A general personal computing magazine. Feature articles on the microcomputer and its workings, software, product developments and interviews. Regular columns include commentaries, industry news, book reviews and letters to the editor. Advertising is included.*

Computer User (Cerritos). Ed. Catherine Semar. 1983. monthly. \$24.95. circ. 316,000. McPheters, Wolfe & Jones, 16704 Marquardt Ave., Box 1234, Cerritos, CA 90701. Tel.: 213-926-9540. *Articles cover information on computers for home and business use. Includes columns on computerized games, new products, computer listings and letters. Advertising is included.*

Computer User (Minneapolis). Ed. Dole Archibald. monthly. \$12. circ. 80,000. 12 S. 6th St., No. 1030, Minneapolis, MN 55402. Tel.: 612-339-7571. *A general microcomputer magazine for professional and home users. Each issue features sections for business & finance, training & education and computer law applications. Advertising is included.*

Computers & Electronics. Ed. Arthur P. Salsberg. (Formerly until 1982): Popular Electronics). 1954. monthly. \$15.97. circ. 400,000. Ziff-Davis Publishing Co., Consumer Division, One Park Ave., New York, NY 10016. Tel.: 212-725-3516. *Offers information on all aspects of computers and computer electronics. Coverage of microcomputers is included in occasional feature articles and regular columns. Advertising is included.*

Computers in Accounting. Ed. M. Bischoff. 1984. every 2 months. \$36. 964 Third Ave., Ste. 3510, New York, NY 10155. Tel.: 212-935-9210. *For accounting and financial executives. Features articles on software selections (including electronic spreadsheets, charts and graphics), hardware, peripherals and user groups. Regular columns cover programming tips, software evaluations, hardware reports, new applications and a directory of new products.*

Computers in Education. Ed. Karen Studebaker. 1981. monthly. \$18. Studebaker Technology, 189 Newton Ave., Glen Ellyn, IL 60137. Tel.: 312-858-7869.

Computers in the Schools: the interdisciplinary journal of practice, theory, and applied research. Ed. D. LaMont Johnson. 1984. quarterly. \$24 to individuals; institutions \$30; libraries \$40. Howarth Press, Inc., 28 E. 22nd St., New York, NY 10010. Subscr. to: 75 Griswold St., Binghamton, NY 13904. *For all educators and school administrators. Features articles which combine theory and practical applications of small computers in schools.*

Computers, Reading and Language Arts: a teaching resource. Ed. Gerald H. Block. 1983. quarterly. \$16 for individuals; institutions \$22. circ. 10,000. Modern Learning Publishers, Inc., 1308 East 38th St., Oakland, CA 94602. Tel.: 415-530-9587. Subscr. to: Box 13247, Oakland, CA 94661-0247. *For pre-college educators. Features articles on computer-aided instruction in reading and language arts. Regular columns contain reviews of applicable books and software as well as news of events and new products. Advertising is included.*

Computerworld: newsweekly for the computer community. Ed. John C. Whitmarsh. 1967. weekly. \$44. circ. 122,258. C W Communications, Inc., 375 Cochituate Rd., Box 880, Framingham, MA 01701. Tel.: 617-879-0700. *Articles cover every aspect of the computer community and industry. In-depth reports, news, software, communications, systems, peripherals, office automation and editorials are all featured. Advertising is included.*

Computing Resources for the Professional. Ed. Richard Oberg. 1981. every 2 months. \$24. University of Washington, Computing Information Center, HG-45, 3737 Brooklyn Ave., N.E., Seattle, WA 98105. Tel.: 206-543-5818. *A compilation of computer books, periodicals and articles. Regularly features book reviews. No advertising is included.*

Data Training: the monthly newspaper for information trainers. Ed. Floyd Demske. 1981. monthly. \$24. circ. 20,000. Warren-Weingarten, Inc., 38 Chauncy St., Boston, MA 02111. Tel.: 617-542-0146.

Easy Home Computer. Ed. Roger C. Shorpe. 1983. monthly. \$2.50 per no. circ. 125,000. Pumpkin Press, Inc., 350 Fifth Ave., Ste. 6204, New York, NY 10118. Tel.: 212 947 4322. *For the novice computer user. Feature articles and columns cover hardware, software, peripherals, programming and games. Advertising is included.*

Education Computer News: bulletin on classroom technology. Ed. Pamela Rowe. 1984. bi-w. \$147. Capitol Publications, Inc., 1300 N. 17th St., Arlington, VA 22209. Tel.: 703 528 5400.

Educational Technology. Ed. Lawrence Lipsitz. 1961. monthly. \$49. circ. 5,000. Educational Technology Publications, Inc., 720 Palisade Ave., Englewood Cliffs, NJ 07632. Tel.: 201-871-4007.

Electronic Games. Ed. Arnie Katz. 1981. monthly. \$28. circ. 200,000. Reese Communications, Inc., 460 W. 34th St., New York, NY 10001. Tel.: 212-947-6500. Subscr. to: Electronic Games, Subscr. Dept., Box 1128, Dover, NJ 07801. *For home users interested in entertainment software. Articles cover recreational software, electronic games and programs. Columns include questions and answers, letters from readers and product announcements. Advertising is included.*

Electronic Games Hotline. 1982. bi-w. \$25. Reese Communications, Inc., 460 W. 34th St., New York, NY 10001. Tel.: 212-947-6500.

Electronic Learning. Ed. Jack Roberts. 1981. 8 per yr. \$19. circ. 50,000. Scholastic Learning Inc., 730 Broadway, New York, NY 10003. Tel.: 212-505-3000. Subscr. to: 902 Sylvan Ave., Englewood Cliffs, NJ 07632.

For educators and educational administrators of all levels. Features articles on the applications and advances of technology in the classroom. Regular columns include news briefs, software reviews, new product and software announcements and the "Resource Center," which covers miscellaneous items of interest. Advertising is included.

Family Computing. Ed. Claudio Cohl. 1983. monthly. \$19.97. circ. 375,000. Scholastic Inc., 730 Broadway, New York, NY 10003. Tel.: 212-505-3580.

A family magazine devoted to home uses of microcomputers. Features articles on a variety of topics, from applications and maintenance to profiles of families and their experiences with computers. Also includes buying information, programming information for beginners, interviews with computer people and reviews of hardware, software and books. Advertising is included.

Farm Computer News. Ed. Gary Vincent. 1981. monthly. \$40. circ. 3,500. Meredith Corporation, Successful Farming, 1716 Locust St., Des Moines, IA 50336. Tel.: 515-284-3000.

Hands On! Ed. Robert F. Tinker. 1977. 4 per yr. \$20. circ. 10,000. Technical Education Research Center (TERC), Technical Center, 1696 Massachusetts Ave., Cambridge, MA 02138. Tel.: 617-547-3890. *For elementary through college level educators and administrators. Each issue contains a feature article, an editorial and columns on classroom computing, book and software reviews as well as TERC news and a bulletin board of information. No advertising is included.*

Publications

General Computer Mags. Cont.

Home Computer Magazine. Ed. Gary Kaplan. (Former title: 99'er Home Computer Magazine). 1981. monthly. \$25 . circ. 250,000. Emerald Valley Publishing Co., Box 5537, 1500 Valley River Dr., Suite 200, Eugene, OR 97401. Tel.: 503-485-8796.

Home Computer Review. 1984. monthly. Viare Publishing Co., 350 E. 81st. St., New York, NY 10028. Tel.: 212-734-4400.

Home Entertainment. Ed. Judith Morrison. (Formerly (until 1983): Home Entertainment Quarterly). 1982. every 2 months. \$3 per no. circ. 125,000. Home Entertainment Publications, Inc., 220 Westbury Ave., Corle Place, NY 11514. Tel.: 516-334-7880.

Hot Off the Computer. Ed. Barbara Newmark-Kruger. 1983. 10 per yr. \$12. Westchester Library Systems, 8 Westchester Plaza, Cross Westchester Executive Park, Elmsford, NY 10523. Tel.: 914-592-8214.

A general interest computer magazine. Articles cover software reviews, database information, reviews of microcomputer books and magazines, including submissions from readers. No advertising is included.

Journal of Financial Software and Hardware. Ed. R.L. Sage. (Former title (until 1984): Journal of Financial Software). 1983. every 2 months. \$20. circ. 100,000. Microthought Publications, 2811 Wilshire Blvd., Ste. 640, Sonta Monica, CA 90403. Tel.: 213-829-7385. *For accounting, tax, banking and finance, financial planning and investment professionals. Provides current information to better educate buyers with the purchasing of software products. Includes a software directory, articles on the software industry and finance. Regular columns include software reviews, editorials, and a reader service department. Advertising is included.*

Kids Computer Connector. Ed. James Tartaglia. 1982. quarterly. \$8. Computar Inc., Old Harwick Rd., Barre, MA 01005. Tel.: 617-355-2859.

Leisure Time Electronics. Ed. William Silverman. monthly. \$20. circ. 50,175. U S Business Press, Inc., 124 E. 40 St., New York, NY 10016. Tel.: 212-953-0230.

Microzine. every 2 months. \$149. Scholastic, Inc., 730 Broadway, New York, NY 10003. Tel.: 212-505-3000. Subscr. address: Box 645. Lyndhurst, NJ 07071-9986. *For secondary school students and teachers. An introductory guide for children to the world of computing. Features graphics, programs, posters and guides. Advertising is included.*

Modem Notes: on line to the business community. Ed. Katherine Ackerman. 1983. monthly. \$36. Cache Data Products, Inc., 2921 South Brentwood Blvd., St. Louis, MO 63144. Tel.: 314-962-1015. *For personal computer users. Features articles on modems and their applications. Offers information and reviews of databases that can be accessed online.*

National Educational Computer Review. 5 per yr. \$12. circ. 50,000. National Education Computer Library, 16 Main St., New Milford, CT 06776. Tel.: 203 354 7760.

Online (Weston). Ed. Jeffrey K. Pemberton. 1976. 6 per yr. \$78. circ. 4,000. Online, Inc., 11 Tonnerly Lane, Weston, CT 06883. Tel.: 203-227-8466. *For online information systems users. Articles cover a variety of online applications for general and business use. Regular columns include reviews of recently published articles of interest to online users, suppliers, U.S. and European news and letters to the editor. Advertising is included.*

Personal Computer News: the national computersource for hardware, software & news. Ed. K. Reed Huegel. 1982. monthly. circ. 20,000. Box 848, Port Reyes, CA 94956-0848. *Features articles on hardware, software and applications. A regular column contains book reviews. Advertising is included.*

Robotics Age: the journal of intelligent machines. Ed. Carl T. Helmers, Jr.. 1979. monthly. \$24. circ. 17,000. Robotics Age, Inc., 174 Strand Bldg., 174 Concord St., Peterborough, NH 03458. Tel.: 603-924-7136. *Feature articles offer information on robotic technology developments and applications including microcomputers. Regular columns include abstracts of pertinent articles from other publications, new product announcements and a calendar of events. Advertising is included.*

School Microcomputing Bulletin. Ed. Lee M. Joiner. 1982. monthly. \$28. circ. 750. Learning Publications, Inc., Box 1326, Holmes Beach, FL 33509. Tel.: 616-372-1045. *For Primary and Secondary school educators. Features articles and news briefs covering computer-assisted teaching, curriculum and school policies, hardware and software purchasing and computer applications for administrative offices. No advertising is included.*

Small Computers in the Arts News. Ed. Eric Podietz. 1982. 10 per yr. \$10. circ. 250. Small Computers in the Arts News-Network, Box 1954, Philadelphia, PA 19105.

Social Science Micro Review. Ed. G. David Garson. (Formerly (until 1984) : Political Science Micro Review). 1982. quarterly. \$10. circ. 200. North Carolina State University, Social Science Research and Instructional Computing Lab, Link 212 NCSU, Raleigh, NC 27650. Tel.: 919-737-2481.

T.H.E. Journal. Ed. Sylvia Chorp. 1973. 10 per yr. circ. 70,500. Information Synergy, Inc., Box 17239, Irvine, CA 92713. Tel.: 714-261-0366. *For educators of all levels. Articles are focused around a specific topic for each issue; technological innovations as they apply to education. Regular columns feature listings of computer shows, conferences and symposia, book reviews and announcements of new publications, software and products. Advertising is included.*

Teaching and Computers. Ed. Jack L. Roberts. 1983. 8 per yr. \$19. Scholastic Inc., 730 Broadway, New York, NY 10003. Tel.: 212-505-3000. Subscr. to: 902 Sylvan Ave., Englewood Cliffs, NJ 07632.

For Elementary classroom teachers. Features articles on applications and methods of computer-assisted instruction and integrating computers into the classroom environment. Monthly columns include tips, programs, questions-and-answers, a calendar of events, product announcements and reviews of pertinent software and books. Advertising is included.

Turtle News. Ed. James H. Miller. 1981. monthly. \$25. circ. 2,000. Young Peoples' Logo Association, Box 855067, Richardson, TX 75085. Tel.: 214-243-7190. *For secondary school students and educators interested in computer technology. Features articles on programming in various languages such as LOGO, PILOT and BASIC. Regular columns include letters to the editor and software exchange information. No advertising is included.*

Used Computer Guide: the microcomputer bluebook. Ed. Scott Hirsch. 1984. quarterly. \$37.50. circ. 275. (Trade Broker, Inc.). Hansen Publishing Company, 8455 S.E. 37th St., Box 1194, Mercer Island, WA 98040.

User's Guide. Eds. Tony Bove, Cheryl Rhodes. (Formerly: User's Guide to C P-M Systems & Software). 1983. every 2 months. \$18. circ. 30,000. T U G, Inc., Box 5245, Redwood City, CA 94063. Tel.: 415-364-0108.

For CP-M and DOS users. Features articles on hardware and software as well as general and specialized applications. Regular columns include evaluations of computer systems, product announcements and reviews. Advertising is included.

Video Game All-Stars. Ed. Jeff Hirsch. monthly. \$15. circ. 7,000. Video Newsletter Associates, 666 Old Country Rd., Garden City, NY 11530. Tel.: 516-222-1055.

Video Game Update & Computer Entertainer see Computer Entertainer

Wall Street Computer Review. Ed. Pavan Sahgal. 1983. monthly. \$39. circ. 30,500. Dealers' Digest, Inc., 150 Broadway, New York, NY 10038. Tel.: 212-227-1200. *For brokers and investors who use personal computers. Articles cover computer operations, financial databases and technical analysis of the commodities market. Regular columns include letters to the editor, software announcements and reviews. Advertising is included.*

What's New in Personal Computers. 1984. 4 per yr. \$47.88. Adamik Publications, Inc., Rt. 1, Box 202A, Stockton, MO 65785.

CP/M Publications

- BASIC-80 & CP-M: Digital Research BASIC-80 - Microsoft.** Jack J. Purdum. 1983. pap. text ed. write for info. (ISBN 0-02-397020-0). Macmillan.
- Best of CP-M Software.** John D. Halamka. LC 84-50361. 1984. pap. 14.95 (ISBN 0-89588-100-4). SYBEX.
- Business Software for the CP-M Computers: An Applications Directory.** Directories from InfoSource Inc. LC 83-45379. 1984. pap. 12.95 (ISBN 0-8019-7434-8). Chilton.
- Byte Guide to CP-M.** Mark Dahmke & S. Ciarcia. 1983. pap. 16.95 (ISBN 0-07-015072-9, BYTE Bks). McGraw.
- CP-M & the Personal Computer: Popular.** Thomas A. Dwyer & Margot Critchfield. LC 82-20703. 1983. pap. 19.95 (ISBN 0-201-10355-9). Addison-Wesley.
- CP-M Assembly Language Programming: A Guide to Integrated Learning of the CP-M Operating & Assembly Language Programming.** Ken Barbier. 1982. 19.95 (ISBN 0-13-188268-6, Spec); pap. 12.95 (ISBN 0-13-188250-3). P-H.
- CP-M Bible: The Authoritative Reference Guide to CP-M.** Mitchell Waite & John Angermeyer. LC 83-61058. 1983. pap. 19.95 (ISBN 0-672-22015-6, 22015). Sams.
- CP-M Primer.** Stephen Murtha & Mitchell Waite. LC 83-61066. 1983. pap. text ed. 16.95 (ISBN 0-672-22170-5, 22170). Sams.
- CP-M Revealed.** Jack Dennon. 1983. pap. 15.95 (ISBN 0-8104-5204-9, 5204). Hayden.
- CP-M Software Finder.** Que Staff & Digital Research Staff. 1983. pap. 14.95 (ISBN 0-88022-021-X, 13). Que Corp.
- CP-M Programmer's Encyclopedia.** Bruce Brigham. 1984. pap. 19.95 (ISBN 0-88022-043-0, 31). Que Corp.
- CP-M Simplified.** Jeffrey R. Weber. LC 81-66910. 1982. pap. 13.95 (ISBN 0-938862-04-9). Weber Systems.
- CP-M Software Finder.** Que Staff & Digital Research Staff. 1983. pap. 14.95 (ISBN 0-88022-021-X, 13). Que Corp.
- CP-M Software Review.** Michael L. Gonzales. 1984. pap. text ed. 19.95 (ISBN 0-8359-1101-2). Reston.
- CP-M Solutions.** Ken Barbier. 1985. 22.95 (ISBN 0-13-188186-8); pap. 14.95 (ISBN 0-13-188178-7). P-H.
- CP-M System.** Cyborg Software Systems Incorporated et al. 1984. pap. 5.95 (ISBN 0-915069-20-2). Nanos Sys.
- CP-M Techniques.** Ken Barbier. 1984. 27.95 (ISBN 0-13-187865-4); pap. 19.95 (ISBN 0-13-187857-3). P-H.
- CP-M Users Guide.** Carol A. Ogdin. 1981. text ed. 21.95 (ISBN 0-8359-1103-9). Reston.
- CP-M User's Manual.** 20.00 (ISBN 0-318-01354-1). Mountain View Pr.
- Exploring Word Processors: CP-M Edition.** Carl Townsend. 1984. pap. 14.95 (ISBN 0-88056-104-1). Dilithium Pr.
- Free Software Handbook: 1984-85 CP-M Edition.** Blake H. Van Meter & Patricia L. Hatcher. 1984. pap. 17.95 (ISBN 0-915907-07-0). Peopletalk.
- How to Get Started with CP-M: Control Programs for Microcomputers.** Carl Townsend. LC 80-70783. 1981. pap. 13.95 (ISBN 0-918398-32-0). Dilithium Pr.
- How to Operate Your Computer under CP-M.** David Studebaker & Karen Studebaker. Ed. by Patricia A. Menges. 1983. wkbk. & tapes 60.00 (ISBN 0-318-01220-0). Flip Track.
- How to Operate Your Computer under CP-M 86.** David Studebaker & Karen Studebaker. Ed. by Janice S. Rinehart. 1983. wkbk. & tapes 75.00 (ISBN 0-318-01221-9). Flip Track.
- Making CP-M-80 Work for You.** The Human Connection. 15.95 (ISBN 0-8306-0764-1); pap. 9.25 (ISBN 0-8306-1764-7, 1764). TAB Bks.
- Mastering CP-M.** Alan R. Miller. LC 82-62006. 1983. pap. 17.95 (ISBN 0-89588-068-7, C302). SYBEX.
- Practical Guide to CP-M.** Carl Townsend. Ed. by Tim Barry. 1983. pap. 14.95 (ISBN 0-88056-077-0). Dilithium Pr.
- Programmer's CP-M Handbook.** Andy Johnson-Laird. 1983. pap. 21.95 (ISBN 0-88134-103-7). Osborne-McGraw.
- Programmer's Guide to CP-M.** Ed. by Sol Libes. 1983. pap. 12.95 (ISBN 0-916688-37-2, 14C). Creative Comp.
- Systems Programming under CP-M 80.** Lawrence Hughes. 1982. text ed. 24.95 (ISBN 0-8359-7457-X); pap. text ed. 17.95 (ISBN 0-8359-7456-1). Reston.
- Understanding CP-M.** Joseph Reymann. 1984. pap. 2.95 (ISBN 0-88284-269-2). Alfred Pub.
- User-Friendly Guide to CP-M 2.2.** James Perry & Robert McJunkins. 1983. 16.95 (ISBN 0-8359-8117-7). Reston.
- User's Guide to CP-M Systems.** Tony Bove & Cheryl Rhodes. 1984. pap. 6.95 (ISBN 0-671-55921-4, Pub. by Baen Books). PB.
- Using CP-M.** Judi N. Fernandez & Ruth Ashley. LC 80-36673. 1980. pap. text ed. 15.95 (ISBN 0-471-08011-X, Pub. by Wiley Pr). Wiley.

Z-80 Books

These books are recommended for the advanced ADAM programmer to learn programming skills in machine language.

- Assembly Language Programming: Z-80.** Lance A. Leventhal et al. 1979. pap. text ed. 18.95 Osborne-McGraw.
- Build Your Own Z80 Computer.** Steve Ciarcia. 1980. (BYTE Bks); pap. 19.95 McGraw.
- Data Communications for Microcomputers: Practical Experiments for Z80 Based Microcomputers.** Joseph Nichols et al. 1983. pap. 17.95 McGraw.
- Eighty-Eighty & Z80 Assembly Language: Techniques for Improved Programming.** Alan R. Miller. 1981. pap. text ed. 12.95 Wiley.
- Getting Started with 8080, 8085, Z80, & 6800 Microprocessor Systems.** James W. Coffron. 1984. pap. 14.95 P-H.
- Introducing Z80 Assembly Language Programming.** Ian R. Sinclair. 1983. 11.95 Focal Pr.
- Z80 Assembly Language Subroutines.** Lance A. Leventhal & Winthrop Saville. 1983. pap. 17.95 Osborne-McGraw.
- Z80 Machine Code for Humans.** Alan Tootill & David Barrow. 1985. pap. 12.95 P-H.
- Z80 Microcomputer Design Projects.** William Barden, Jr. 1980. pap. 14.95 Sams.
- Z80 Microcomputer Handbook.** William Barden, Jr. 1978. pap. 13.95 Sams.
- Z80 Microprocessor.** Shirley A. Nanos & Paul P. Nanos. 1982. 4.95 Nanos Sys.
- Z80 Reference Guide.** Allan Tully. 1984. pap. 14.95 Melbourne Hse.
- Z80 Software Gourmet Guide & Cookbook.** Nat Wadsworth. pap. 17.50 Hayden.
- Z80 User's Manual.** Joseph Carr. 1980. text ed. 21.95 O.P. pap. text ed. 16.95 Reston.
- One Hundred One Projects for the Z80.** Frank P. Tedeschi & Robert Colon. 1983. 23.95 ; pap. 16.95 TAB Bks.
- Practical Hardware Details for 8080, 8085, Z80, & 6800 Microprocessor Systems.** James W. Caffron. 1981. text ed. 28.95 P-H.
- Programming the Z80.** Rodney Zaks. LC 81-51131. pap. 19.95 SYBEX.
- TRS-80 Z80 Assembly Language Library.** Craig A. Lindley. 1983. looseleaf binder 34.97 Green Pub Inc.
- TRS-80 Z80 Assembly Language Library.** incl. disks 29.97 Green Pub Inc.
- Using the Z80 in the TRS-80.** Elmer Poe. LC 82-50651. 1982. pap. 13.95 Sams.
- Z80 Applications.** James W. Coffron. LC 83-60950. 1983. pap. 15.95 SYBEX.



The Retailers Section

Retailers, Mail-order Companies, and Software Producers

We receive letters all the time stating they can't find anything for their ADAM COMPUTER at their local store...which is usually very true! Software & hardware is hard to find in most parts of the country, however, there is a solution....

Do not fear ! There is plenty available for the ADAM...You just have to know where to find it...& on the next several pages, we're going to tell you where to find ANYTHING IN THE GALAXY for ADAM!!

Probably at least 90% of your future purchases as an ADAM owner will have to be done through mail-order. If you're not used to this, it's not really so bad. (You probably purchased this directory that way, right!?!...& see what a great deal you got!!!!)

We cannot guarantee favorable results from every source we have listed, as we have no control over them, however, we are familiar with a majority of these sources and believe you will have very little problems. Most of the ADAM companies are small and take pride in their service & products. It's just like anything else, it pays to shop around. Competition keeps things alive! (By the way...Be sure to check out our **Shopper-Section** for some good buys.) We suggest you look through this list of over 100 sources for ADAM supplies, decide what you're looking for, then perhaps send a few SASEs to request their latest catalog or product listing.



Adam Retailers

C JAAL COMPUTING

PO BOX 8006
Laguna Hills, CA 92654

*
Hardware, low cost voice synthesizer.

C JACTIVISION

Drawer 7287
Mountain View, CA 94039
800-227-9757

C JADAM TECH

P.O. BOX 41434
Phoenix, AZ 85080

C JADAM WORLD ENTERPRISES

424 E. John St.
Linden Hurst, NY 11757

*
Software

C JADAM'S APPLE

4835 Edsal
Cleveland, OH 44124

*
Software, newsletter, public domain software.

C JADAM-X-CHANGE

12863 Washburn
Wolcott, NY 14590

C JADAMAGIC

1634 N. Thompson Dr.
Bay Shore, NY 11706

*
Software -Game Paks I & II and CP/M Paks I & II

C JADAMLAND

795 Garfield
Lander, WY 82520

*
Hardware, user group, newsletter, (SEE ADAM SHOPPER SECTION)

C JADAMNET

Drawer 510
Uniontown, AR 72955

*
Digital Data Drives.

C JADAMNET USER'S GROUP

P.O.Box 510
Uniontown, AR 72955

*
publication

C JADAMWARE

711 Pecan Dept. F-7
Texarkana, AR 75502

*
Software

C JAL CAMISA

7615 Glenbrook Ct.
Pleasanton, CA 94566

*
Horse race handicapping programs.

C JALPHA-1

1671 E.16th St.Suite 146
Brooklyn, NY 11229
718-336-7612

*
Software, Hardware, & Misc. supplies. SEE SHOPPER SECTION

C JAMERICAN DESIGN COMP.

62 Joseph St.
Moonachie, NJ 07074
800-524-0809

*
Discount hardware-data drives, keyboards, power supply, etc...

C JAML

71-38 Myrtle Ave.
Queens, NY 11385
718/326-1110

*
Carries ADAM products. Specifics unknown at press time.

C JAPE SOFTWARE

4756 Lalande Blvd.
Pierrefonds,

*
Quebec HBV 1V2
Canada

C JAVIMAR INC.

P.O. Box 475
Voorhees, NJ 08043



C JC & A PRODUCTS

RR 2 BOX 552
Rolla, MO 65481

*
Manufactures a "high-performance digital data pack tailored for word processing. Offers faster & smoother tape operation & increased file capacity. SEE SHOPPER SECTION

C JC&C DISTRIBUTERS

P.O. BOX 76
Stratford, NJ 08084

*
Software, program listings

C JCALDERON SOFTWARE INC.

155 Denart Ave.
Staten Island, NY 10303

*
Software, SEE SHOPPER SECTION

C JCAPITAL SOFTWARE

P.O. Box 370
St. Louis, MO 63032

*
c-interface

C JCBS

One Faucett Place
Greenwich, CT 06836
203-622-2525

C JCHALLENGE WARE

1017 Brewster Court
Grafton, OH 44044
216-926-2671

*
Software-SEE SHOPPER SECTION

C JCHAZE PRODUCTS

P.O. BOX 17
Monson, MS 01057

C JCOMMAND COMPUTERS

9229 Todd Drive #104
Birmingham, AL 35206
205-833-9376

*
Software & Accessories

C JCOMPUTER DISCOUNT CENTER

P.O. Box 1548
Springfield, VA 22151
703-323-8667

Adam Retailers

[JCOMPUTER ENTERTAINER

12115 Magnolia Blvd #126
No.Hollywood, CA 91607
818-761-1516

*

Publication, no advertizing.

[JDATA BACK-UP

BOX 335
Iona, ID 83427

*

Data Paks, misc. accessories.

[JDAVASAN SOFTWARE

S. 1829 Glenrose Rd.
Spokane, WA 99203

*

Software & Accessories

[JDELTA MICRONICS

BOX 10933
Erie, PA 16514

*

[JDHA HOBBY CRAFTS

5204 Midmoor Rd
Monona, WI 53716

*

[JDO NOT STAMP SOFTWARE

2608 West 800 South
Roy, UT 84067
801/773-7766

*

825-5336 Public domain (freeware)
at low cost available.

[JELLIAM ASSOCIATES

24000 Bessemer St.
Woodland Hills, CA 91367

*

Complete line of CP/M Software.See
CP/M Section.

[JEMCO

3541 Old Conejo Rd.
Newbury Park, CA 91320

*

[JEVE ELECTRONICS

2 Vernon St.Suite 404
Framingham, MA 01701

*

Complete line of "advanced"
hardware for ADAM. See Hardware
Section for details.Eve is the
leading manufacturer of ADAM
Hardware.

[JEVERYTHING'S ADAM

BOX 579
Gwynedd Valley, PA 19437
215-643-7666

*

[JEXTENDED SOFTWARE CO.

11987 Cedarcreek Dr.
Cincinnati, OH 45240

*

Software- accepts new software for
development.(take note programmers)

[JEZRA

Box 5222AU
San Diego, CA 92105

*

Offers free programs
for Adam, Apple, TI99 & others.
Send stamps for further info.

[JFISHER PRICE

P.O.BOX 1327
Cambridge, MA 02238
617-494-1222

*

Learning (educational)software.

[JFLIPTRACK LEARNING SYST.

999 Main suite 200
Glen Ellyn, IL 60137
800-222-FLIP

*

An audio cassette course on using
the ADAM.(2-cassettes)

[JFUTURVISION

P.O.BOX 34
N.Billerica, MA 01862
617-663-8591

*

Sound & Music, utility software.

[JH&R CORPORATION

401 E. Erie Ave.
Philadelphia, PA 19134
215-426-1708

*

Surplus parts for ADAM.Keyboards,
power supplies,data drives.low
prices.

[JHANIA ENTERPRISES, LTD

PO BOX 356
Tinley Park, IL 60477
532-1206

*

Astronomy program for ADAM.
Excellent program for those with
this area of interest.

[JHI-TEK RESEARCH & MAR LTD

244 PENBROOKE CLOSE S.E.
Calgary Alberta, T2A 3P1

*

CANADA - Interface, modems, disk
drives, software

[JI.M.C.S.

818 Birch Ave.
Coeur d'Alene, ID 83814

*

Software-plans to carry
a small line of D-packs, Disks,
Labels, etc...

[JIMAGE MICROCORP

P.O.Box 3761
Cherry Hill, NJ 08034
609-667-2526

*

Hardware & Software - accepts new
software for development.

[JIMAGIC

981 University Ave.
Los Gatos, CA 95030

*

ATTENTION:Kathleen Booth - Software

[JINTERNATIONAL COMPUTING

P.O.Box 176
Patterson, NJ 28661

*

[JINTERPHASE TECHNOLOGIES

6391 F.Westminster Hwy
Richmond, BC

*

Canada V7C 4V4

[JJ CHECK SOFTWARE

BOX 345
Millry, AL 36558

*

Retailers

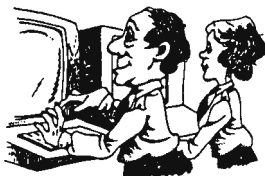

Adam Retailers

C JJ STANLEY CO.

195 Reservoir St.
Marbord, MA 01752

*

C JJAMECO ELECTRONICS

1355 Shoreway Rd.
Belmont, CA 94002

*

Surplus parts for ADAM.

C JJ.J.'s GOURMET H&S EMPOR.

5665 Myers rd.
Akron Ohio, OH 44319-5139
216/882-5633

*

Reconditioned hardware
at reasonable prices. Software, too.
Call for availability of items.

C JJOHN F. BUSBY II

6634 SW 41st St.
Davie, FL 33314

*

Keyboard overlays, iron-
on decals, SEE SHOPPER SECTION

C JKING COMPANY

6510 Old Chesterbrook Rd
McLean, VA 22101

*

Supplies

C JKRAY

17888 Maybury
Fraser, MI 48026

*

C JL.O.F.

BOX 587
York, PA 17405

*

Manual to make back-ups
& format cassettes.

C JLAS VEGAS ADAM CLUB

P.O. BOX 81146
Las Vegas, NV 89103

*

Software package, also
blank digital data packs
(economical price) SEE SHOPPER
SECTION

C JLOIR ELECTRONICS CORP.

13933 N. Central Exp.
Dallas, TX 75243
214-234-8032

*

Coleco joysticks (\$2.95 each,
10/\$25)

C JLORANGER MANUFACTURING

BOX 740
WARREN, PA 16365

*

Manufactures digital
data packs.

C JM.W. RUTH CO.

510 Rhode Island Ave.
Cherry Hill, NJ 08002
609-667-2526

*

Complete line of
products: Hardware, Software, Books
Etc..

C JMAGIC WAND ENTERPRISES

349 Lincoln St.
Hingham, MA 02043

*

C JMANUVID

28 Vidalia
Winnipeg,

*

Manitoba, Canada R2V 3B9

C JMARATHON COMPUTER PRESS

P.O. Box 88503
Virginia Beach, VA 23455

*

Utility software,
hardware, publications, SEE SHOPPER
SECTION

C JMARTIN CONSULTING

94 Macalest Bay

*

Winnipeg Canada
R3T 2X5 CANADA
SmartBasic Bonanza package, text
adventure software maker.

C JMICRO 2

4522 W. Beryl
Glendale, AZ 85302
602-931-3913
Home, business & educational
software. (Call collect to order)

C JMICRO-FUN LAB

2699 Skokie Valley Rd.
Highland Park, IL 60035

*

Att: Susan Goldberg

C JMMSG

P.O. BOX 1112
Broomfield, CO 80020-8112
303-465-1561

*

Back-up software.

C JNATIONAL A-CLUB

PO BOX 15068
Chevy Chase, MD 20815

*

Correspondence course
for basic programming and assembly
language.

C JNIAD

2089 Carriage Hill Rd
Lisle, IL 60532
312-961-3929

*

Monthly publication,
buying service. SEE SHOPPER SECTION

C JNICKELODEON GRAPHICS

5640 W. Brown
Glendale, AZ 85302

*

Software, SEE SHOPPER
SECTION

C JORPHANWARE

5665 Myers Rd
Akron, OH 44319
216/882-4720

*

Complete line of
Hardware & Software. Manufactures
memory expander, RS232 Interface,
Centronics Printer Interface &
other hardware.

C JOVERPRICED SOFTWARE

P.O. BOX 89
Farmington, CT 06034

*

Produces SPLAT-280 and
JKL Utilities software.

Retailers

Adam Retailers

C JP. & B. HINKLE

117 Northview Rd
Ithaca, NY 14850

*

Publishes the HACKER'S GUIDE TO ADAM. (vol 1 & 2) SEE ADAM SHOPPER SECTION.

C JPAPPAS PRODUCTS

131 Dodge Street
Beverly, MA 01915

*

C JPARALLEL SYSTEMS INC.

P.O. Box 772
Turnersville, NJ 08012
609/227-9634

*

C JPARKER BROS.

P.O. BOX 1012
Beverly, MA 01915

*

C JPERSONAL PERIPHERALS

1505 S. Green
Longview, TX 75602
214-758-8874

*

C JPIVAR COMPUTING SERVICE

165 Arlington Hgts. Rd.
Buffalo Grove, IL 60089
312/454-6010

*

CP/M conversion service,
from all disk sizes to ADAM format.

C JPRACTICAL PROGRAMS

P.O. Box 244
Kalamazoo, MI 49005

*

Utility software,
hardware, provides product support.
SEE SHOPPER SECTION

C JPUDGET SOUND ADAM NET

22607 SE 322nd
Kent, WA 98042

*

Published "computer
cook book" See user group section.

C JQ-SOFT

P.O. BOX 170
Lavalette, WV 25535

Utility Software

C JRADIO SHACK STORES

(entire chain)

*

Keyboards, power
supplies, economical prices

C JRANDALL MFG. CO.

7800 S.W. 89th
Portland, OR 97223

*

Accessories, printer
quieter.

C JREEDY SOFTWARE

10085 60th St.
Alto, MI 49302
616-868-6588

*

Software-accepts new
software for development. Current
catalog available for SASE. SEE
SHOPPER SECTION

C JREX DOMINGUEZ Jr.

613 Lasalle Ave.
San Francisco, CA 94124

*

manual cassette to datapack

C JSAGE ENTERPRISES

Rt 2 BOX 211 Scrivner Rd
Russellville, MO 65074
314-782-3448

*

Publishes "Expandable
Computer News, Software packages,
Public Domain packs. SEE SHOPPER
SECTION

C JSIERRA SYSTEMS SERVICE

773. Fair Oaks Blvd 179
Carmichael, CA 95608

*

Daisy wheels, ribbons,
tapes

C JSOFTSYNC, INC.

162 Madison Ave.
New York, NY 10016

*

Finance software

C JSPECTRUM ELECTRONICS

14 knightswood Crescent
Brantford,

*

Ontario, Canada N3R 7E6
Hardware- 64K memory expansion
board. Other hardware in
development.

C JSPINNAKER

One Kendall Square
Cambridge, MA 02142
617-494-1220

*

C JSTAR-BYTE, INC.

2564 Industry Lane
Norristown, PA 19403
800-243-1515

*

Software

C JSTEVE JACOBY

BOX 2498
Clearwater, FL 33517
813-595-0641

*

Hardware, Software, Books,
Misc. Business hours 6-9 PM
(Eastern)

C JSUNRISE SOFTWARE INC.

8585 Stemmons Suite 912 S
Dallas, TX 75247
214-630-8171

*

Business hours:
8:30-5:30

C JSYDNEY T DEVELOPING CORP.

15-99 Fifth Ave.
OTTAWA, ONTARIO,

*

Canada K1S 5K4

C JTAPEWARE TECHNOLOGY

P.O. BOX 95071
Atlanta, GA 30347
404-498-3831

*

C JTELEGAMES USA

Box 901
Lancaster, TX 75146
(214)227-764

*

Cartridge software.

Retailers



Adam Retailers

[THE ADAM DEPOT

419 Ridgway Ave.
Johnsonburg, PA 15845

*

Software, Hardware, Books,
Supplies.

[TIME OUT

7208 N. 145th E. Ave
Owasso, OK 74055

*

Checkbook program

[TOM MADITZ

114 E. 3rd St. Apt. 305
Weston, WV 26452

*

Yahtzee Game (\$5)

[TOYS R US

(entire chain)

*

ADAMS, hardware, software

[TR BEDNAR INDUSTRIES

Suite 307, 5815 W. Capitol
Milwaukee, WI 53216

*

Rewinding kit to
recycle ribbons.

[U. E. T.

279 Eastholm
Akron, OH 44312

*

Software

[JUNGLE ERNIE'S

279 Eastholm
Akron, OH 44312

*

Utility Software, Data
paks.

[UNIVERSAL INTERFACE SYS

Suite 133-20465 Douglas
Langley, B.C., V3A 4B6

*

Canada- 64k memory
expansion card

[VICTORY SOFTWARE

2564 Industry Lane
Norristown, PA 19403

[VIDEO TAKE-OUT

12115 Magnolia #126
North Hollywood, CA 91607
800-228-1336

*

Hours: 9-5 Pacific Time,
Software, supplies, books.

[VIDSKI

894 Inwood Place
Rahway, NJ 07065

*

Music & drawing
software

[W/PUG

P.O. Box 144
Malverne, NY 11565

*

Publication-exclusively for word
processing

[WALTER'S SOFTWARE

RD #4 Box 289A
Titusville, PA 16354
814/827-3776

*

\$2-instructions on how
to convert your games to disk
yourself. Software

[WATT

26 81-B Marietta Ave.
Kenner, LA 70062
(504) 464-6894

*

A Program a month. write
or call for details.

THIS SPACE FOR
ADDITIONS

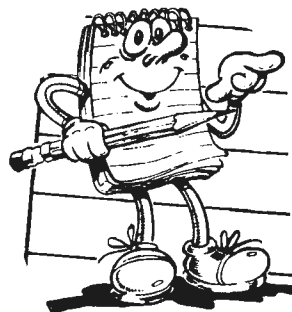

Retailers

RESOURCES FOR COMPUTER ACCESSORIES & SUPPLIES

THE FOLLOWING IS A LIST OF COMPANIES THAT CARRY GENERAL COMPUTER PRODUCTS & SUPPLIES. THESE ARE NOT SPECIFICALLY ADAM PRODUCTS, BUT MANY CAN BE USED WITH YOUR ADAM SET-UP. WE SUGGEST YOU CALL FOR THEIR LATEST CATALOGS. MOST OF THE COMPANIES HAVE A TOLL-FREE "800" NUMBER. SIT DOWN, TAKE ABOUT AN HOUR, MAKE A COUPLE DOZEN FREE CALLS, AND IN A FEW DAYS YOUR MAIL-BOX WILL BE FULL OF ALL KINDS OF COMPUTER RELATED JUNK MAIL. YOU MIGHT JUST FIND SOME GREAT BUYS! GO TO IT!!

Suncom, Inc. 260 Holbrook Drive Wheeling, IL 60090 (312) 459-8000	Disk cleaner. Printer/ monitor stands. Dust covers. Desk light. Disk boxes. Copy stand. Disk notcher.	Pfanstiehl 3300 Washington St. Waukegan, IL 60085 (312) 623-1360 (800) 323-9446	Surge protectors. Furniture. Anti-static pad. Disk boxes. Paper. Ribbons. Dust covers. Drive cleaners. Cables.
Tandy Corporation 1800 One Tandy Center Ft. Worth, TX 76102 (817) 390-3700	Disk boxes. Anti-glare screen. Printer/monitor stands. Cables and connectors. Switch boxes. Furniture. Anti-static mat/spray. Surge protector. UPS. Paper.	RAM 8306 Wilshire Blvd., Suite 10 Beverly Hills, CA 90211 (213) 931-6065 (800) 227-2001	Anti-glare/anti-radiation screen filters. Chair.
TrippLite, a division of Tripp Manufacturing Co. 500 N. Orleans Chicago, IL 60610 (312) 329-1777	Surge protectors. Modem line protector. UPS.	Recoton 46-23 Crane St. Long Island City, NY 11101 (718) 392-6442 (800) 223-6009	Drive/screen/CPU cleaners. Surge protector. Anti-static spray. Dust covers.
Z Business Products, Inc. 113 W. 14th Ave. North Kansas City, MO 64116 (816) 474-4455 (800) 821-2473	Continuous form mailing labels. Diskette labels.	Rediform Office Products 15 Monhegan St. Clifton, NJ 07013 (201) 472-5301 (800) 528-1369	Continuous form paper, index cards, mailing labels, and business forms.
Electronic Specialists, Inc. 171 S. Main St. Natick, MA 01760 (617) 655-1532	Surge protectors. Modem line protectors. UPS.	MicroComputer Accessories, Inc. 5405 Jandy Place Los Angeles, CA 90066 (213) 301-9400	Disk boxes. Printer/CPU stands. Anti-glare screens. Dust covers. Keyboard drawers.
Inland 32046 Edward Madison Heights, MI 48071 (313) 583-7150 (800) 521-8428	Surge protector. Modem line protector. Printer/CPU stands. Dust covers. Disk boxes.	Network 203 Harrison Place Brooklyn, NY 11237 (718) 821-7555 (800) 522-2222	Surge/modem protectors. Anti-glare screen. Drive/screen/printer cleaners. Switch boxes.
Innovative Concepts Inc. 1971 Concourse Drive San Jose, CA 95131 (408) 262-6680 (800) 538-7015	Screen/drive/keyboard/ mouse cleaners. Disk boxes. Printer stands. Keyboard covers. Anti-static mats.	O'Sullivan Industries, Inc. 1900 Gulf St. Lamar, MO 64759 (417) 682-3322	Furniture. Monitor stands.
Kalmar Designs Inc. P.O. Box 1400 3303 Merrick Road Wantagh, NY 11793 (516) 221-8400	Disk boxes. Printer/monitor stands.	Panamax 150 Mitchell Blvd. San Rafael, CA 94903 (415) 499-3900 (800) 472-5555	Surge protectors. Modem line protectors. UPS.
Kensington Microware Ltd. 251 Park Ave. South New York, NY 10010 (212) 475-5200 (800) 535-4242	Surge protectors. Fans. Printer stands. Anti-glare screen. Dust covers. Disk boxes. Drive/mouse cleaners.	PerfectData Corp. 9174 Deering Ave. Chatsworth, CA 91311 (818) 998-2400	Disk/screen/keyboard cleaners. Anti-static spray. Printer stand. Disk boxes. Anti-glare screen.
Memorex Media Products 1125 Memorex Drive Santa Clara, CA 95052 (800) 222-1150	Drive/screen/printer cleaners. Printer stand. Disk boxes. Printer ribbons. Continuous form paper.		

Bowater Computer Forms 3000 East Plano Parkway Plano, TX 75074 (214) 578-2000 (800) 527-3412	Continuous form paper and business forms.	Deluxe Computer Forms 530 N. Wheeler St. St. Paul, MN 64046 (612) 631-8500 (800) 328-0304	Continuous form business forms and checks.
Bush Industries, Inc. One Mason Drive Jamestown, NY 14702 (800) 228-2874 (800) 248-2874 (in NY only)	Furniture.	Dennison Carter's Computer Supply Group 275 Wyman St. Waltham, MA 02254 (617) 890-2950 (800) 343-8413	Drive / screen / printer cleaners. Anti-static spray. Printer ribbons. Continuous form labels.
CompuCover P.O. Box 310 #1 Andalusia Mary Esther, FL 32569 (904) 243-5793 (800) 874-6391	Dust covers. Disk wallet.	Eastern Software Distributors, Inc. 3904 Hickory Ave. Baltimore, MD 21211 (301) 366-5100 (800) 638-7563	Continuous form paper. Business forms.
Computer Accessories Corp. 6610 Nancy Ridge Drive San Diego, CA 92121 (619) 457-5500 (800) 582-2580	Surge protector. Monitor stand. UPS. Cables. Switch boxes.	Electronic Protection Devices 35 Dunham Rd. Billerica, MA 01821 (617) 663-0017 (800) 343-1813	Surge protectors. UPS.
Computer Coverup, Inc. 22305 Calumet Chicago, IL 60622 (312) 326-3000 (800) 282-2541	Printer stands. Dust covers. Carrying cases.	ACCO International Inc. 770 S. ACCO Plaza Wheeling, IL 60090 (800) 323-7882 (800) 942-6999 (in IL only)	Surge protectors. Furniture. Disk boxes. Anti-static mat. Anti-glare screens. Lock. Printer stands.
Computerise, Inc. 47-09 30th St. Long Island City, NY 11101 (718) 786-9100 (800) 346-0066	Printer stands. CPU stand. Keyboard drawers.	Alberto Culver 2525 Armitage Ave. Melrose Park, IL 60160 (312) 450-3000	Anti-static spray.
Curtis Manufacturing Company 305 Union St. Peterborough, NH 03458 (603) 924-3823	Printer / monitor / computer stands. Anti-static mat. Surge protectors.	Amaray International Corp. 14935 N.E. 95th St. Redmond, WA 98052 (206) 881-1000	Disk boxes. Printer stand.
Data Spec 20120 Plummer St. Chatsworth, CA 91313 (818) 993-1202 (800) 431-8124	Cables, connectors. Switch boxes. Surge protectors.	Amherst International 540 N. Commercial St. Manchester, NH 03101 (800) 547-5600	Dust covers. Anti-static mats. Carrying cases.
		Automation Facilities Corp. 6383 Rose Lane Carpinteria, CA 93013 (805) 684-5464	Drive cleaners. Screen cleaners.

The User Group Section

You meet the nicest people at User Group Meetings...

...REMEMBER..Never put the datapack in upside down!!!!!!!!!!!!!!!!!!!!

...Old ADAM USERS never die...
...They just lose their MEMORY!!!!



Almost 100 User Groups are listed in this section.



User-Groups

USER-GROUP

#1 ADAM USER'S GROUP

Box 3761 Att:Jay Forman, Cherry Hill, NJ, 08034
607-667-2526 * Jay H. Forman

National group.
Quarterly newsletter. Dues \$15/yr.
Meets Cherry Hill, NJ. 800 members.
P.D. Library.

A. W. AUG

6702 James Lee St., Falls Church, VA, 22042
703-241-0540 * Michael King Sr

Quarterly newsletter.
Dues \$15/yr. Meets Silver Spring,
MA and Tysons Corner, VA. P.D.
Library. 40 members.

A.W. AUG

6702 James Lee St., Falls Church, VA, 22042
*

ADAM & YOU

R 1 Box 331-P, Central Lake, MI, 49622
* Kevin Willson

ADAM AND EVE

2013 Gov. Stevens, Olympia, WA, 98501
206-943-6005 * E. Fehring

ADAM HACKER & USER GR.

lot 357,7001 142 Ave N., Largo, FL, 33541
* J. Tyrrell

ADAM HACKERS USER GROUP

292 BocaCiegaPt. Blvd N., St. Petersburg, FL, 33708
* Robert Niemeyer

20 members, meet
monthly 2nd tues. 7:30 pm at 210
Poinciana L., Harbor Bluffs FL
33540, Dues \$2, Programs \$2 each

ADAM MICROHACKERS

236 McKibben St. Suite 19, New York, NY, 11206
* David Kennedy

ADAM NETWORK

P.O. BOX 85, East Detroit, MI, 48021
*

ADAM OWNERS & USERS GP

19 Eskgrove Street, East Brisbane, , 4109
* Frank Ellis

Australian Club,
Address. 19 Eskgrove Street, East
Brisbane, QLD 4109 Australia, 120
members, Newsletter quarterly,
Dues \$15 US Dollars.

ADAM SOFTWARE CONSORTIUM

9233 Bingham, San Antonio, TX, 78230
*

ADAM SUPPORT GROUP

1970 Fisher Tr. NE, Atlanta, GA, 30345
* John Moore

Adam Smartling BBS-24
hrs:404-424-6258.

ADAM USER CLUB HOLLAND

Vondelstraat 56 2712 RE, Zoetermeer, ,
* W. Huisman

Holland Club Address
Vondelstraat 56 2712 RE, Zoetermeer.

ADAM USER'S GROUP, INC.

P.O. BOX P, Lynbrook, NY, 11563
*

National group - approx.
5000 members

ADAM USER'S OF EL PASO

6308 Falling Star, El Paso, TX, 79912
* Dick Lewin

ADAM USERS GROUP #305

6634 SW 41st St., Davie, FL, 33314
* John F Busby II

ADAM USERS OF CENTRAL VA

38 Rt 664 Chestnut Grove, Earlysville, VA, 22936
* Thomas J Kelly

45 members, meet each
week, have PD library, soon to
print newsletter, Dues to be
announced, Group has conference
board on BBS at 804-286-2929.

ADAM WASHINGTON D.C

1811 St. Roman Dr., Vienna, VA, 22180
Jim Tyson *

ADAM'S APPLE

4835 Edsal Rd., Cleveland, OH, 44124
*

Dues \$10 US/\$14 Foreign,
Bi-Monthly newsletter, PD library.

ADAM-X-CHANGE

12863 Washburn, Wolcott, NY, 14590
*

\$16.95 membership and
two data packs.

User-Groups

AL ROGINSKI

4327 Thorndale Pl., Las Vegas, NV, 89103
* Al Roginski

ALAN L. TAYLOR

612 7th Ave.NE, Stewartville, MN, 55976
507-533-8415 *

call after 6 PM

ALASKA AUG

7210 Bulew Dr., Anchorage, AK, 99507
* Richard J.Bains

Meet twice monthly,
Dues \$15, looking for new members.

AU SOCIAL AUG OF SO. CALI.

1736 S.Bedford St., Los Angeles, CA, 90035
* Harvey Klein

Meets 4th Sunday of each month. at
9700 S. Sepulveda, LA 90045
Publishes monthly newsletter
(\$10/yr) No dues.

AUG OF SAN DIEGO COUNTY

868 N 2nd St. #242, El Cajon, CA, 92021
* Sue Askeu

BAY REGION ADAM INFO

550 27th St.#202, San Francisco, CA, 94131
415-285-3007 * George Havach

Group known as BRAIN.
No dues. Informal network, about 50
members.

BELEVILLE AUG

809 West 33rd Ave., Bellevue, NE, 68005
402-291-4405 * Norman Castro

BENDIGO C.VISION CLUB

W.R.Oldacres-Dear, Bendigo, ,
*

Australian Club Address
W.R. Oldacres-Dear, Cl - 2 Fenton
St., Bendigo, VIC 3550. Meets
monthly,newsletter,30-members,no
dues.

BILL & NANCY RAHN

12426-15th St., Afton, MN, 55001
612-436-6577 *

CENTRAL CALIF. ADAM USERS

20110 Ave. 19, Madera, CA, 93637
299-661-8290 * James Turner,J.

Meets 1st Fri/Mo.
15 members.

CIMINO PIZZA & REST.

5441 N. Second St., Rockford, IL, 16111
*

contact Donald Rob
Lager for info

CLARESHOLM ADAM USERS

Box 820, Claresholm, AB, ,
* Dereh Townsend

Claresholm, AB Canada
TOLOTO. Dues-Free. 12 members. BBS-
404-445-8785.

COLECO ADAM USERS GROUP

1643 Beach St., San Francisco, CA, 94123
*

DANNY LEVITT

4525 S. White Pine, Tucson, AZ, 85730
602-790-9678 *

DAVID SANDAHL

USNH,Box 2844,FPO, Seattle, WA, 98778
*

DENNIS A. JUREWICZ

4553 Forest Hill Dr., Pekin, IL, 61554
*

DENVER ADAMS USER'S GP

1416 Lipan Street, Denver, CO, 80204
*

DEREK TOWNSEND

BOX 820, Claresholm, ,
*

Alberta,Canada TOL OTO

DONALD R. LAGER

5415 N. 2nd St., Rockford, IL, 61111
815-877-7786 *

DOWNTOWN MINNEAPOLIS AUG

3440 Golfview Dr #211, St. Paul, MN, 55123
* Thomas Gilmore

Meets 9:30 AM first Wed.
of each month.6-members,meets at
"Donna's Place" cafeteria downtown.

Dr. STEVE HARRIS

730-N Thurber Dr., Columbus, OH, 43215
614-221-2049 *

User-Groups

USER-GROUP

DWIGHT WAGGENER

4194 Meadow CT, Marietta, GA, 30066
404-928-1016 *

EAST TEXAS ADAM USERS

4105 Forrest Trail, Marshall, TX, 75670
* Jerry Pritchard

EXPANDABLE COMPUTER NEWS

R2 Box 211 Scrivner Rd, Russellville, MO, 65074
314-782-3448 * Darrell R. Sage.

Large membership, PD
libraries Standard and CP/M,
Newsletter Bi-Monthly, Dues \$15,
Reviews Technical information,
Highly recommended.

FIRST CANADIAN AUG

P.O. BOX 547, Victoria Station, ,
*

Westmount,
Quebec H3Z 2Y6

FRANK FLEICH

13381-19 Magnolia Ave., Corona, CA, 91719
*

G HIBBERT

P.O. Box 10, Mistatim, Sask., ,
*

Canadian Group Address
P.O. Box 10 Mistatim Saskatchewan,
S0E 1B0

GARY HILL

Lot 5 Oak Grove, Chapel Hill, NC, 27514
919-968-0299 *

GENESEE VALLEY ADAM USES

5132 Jordan Rd., Silver Springs, NY, 14550
* Don Zimmerman

GREATER CINCINNATI AUG

P.O. BOX 434, Alexandria, KY, 41001
* Keith Bowman

Soon full time BBS,
file up, down loading, help with
problems, spare parts, programs,
etc. 55 members, meet Bi-monthly at
Northern Ky Univ. campus ministry
Bld., newsletter \$9/yr. for 6
issues

H.A.A.U.G.c/Thomas Rutin

1805 14th Ave.N., Texas City, TX, 77590
* Thomas Rutan

HAMILTON-NIAGRA AUG

Grant Frost, , ,
*

11 Lynwood Avenue, Grimsby, Ontario,
L3M-2X5- 100+ members, meets
quarterly, PD library, newsletter,
Dues \$20 Canadian, \$25 US, \$30
overseas.

HARVEY KLEIN

1736 S. Bedford St., Los Angeles, CA, 90035
213-553-1062 *

HAWAII AUG

2335C Apollo Ave., Honolulu, HI, 96818
808/422-4019 * Harlan Fletcher

HERITAGE ADAM CLUB

514 S. 10th, Omaha, NE, 68102
402-342-2565 * Eileen Smith

HOUSTON USER'S GROUP

8954 Shoreview Ln, Humble, TX, 77346
* Russell Clinton

INLAND EMPIRE AUG

P.O. BOX 0, Rialto, CA, 92376
*

Contact-Ann Quental (membership)-
Wendy Ball-Secretary.

J.A. GIRARD

1420 Ave., Langevin Sud, ,
*

Alma, Quebec, Canada G8B
681

JAMES E GILBERT

4608 Lakeview Dr., Huntsville, AL, 35810
*

KANSAS ADAM USERS GROUPS

1325 N. Meridian Apt 201, Wichita, KS, 67203
* Dave Carmichael

55 members, meet
monthly, Three groups working
together with one newsletter, meet
individually pool PD library at
Wichita users group office, Non
Cash donations as dues, Outside
users send stamps to pay for their
mailings.

User-Groups

USER-GROUP

KC USERS GROUP

1513 Tauromee, Kansas City, KS, 66102
* Joe Reardon

KITIMAT ADAM USERS GROUP

1344 Albatross Ave, Kitimat, B.C., ,
*

Canadian Group Address
1344 Albatross Ave., Kitimat, B.C.,
V8C 1P8.

LAKE ERIE ADAM USERS

2110 W. 36th St., Lorain, OH, 44503
*

LAS VEGAS ADAM CLUB

P.O. BOX 81146, Las Vegas, NV, 89103
* Al Roginsky

P.O. BOX 81146
Las Vegas, NV 89103
meets every other
thursday 7-12 PM dues: \$10/yr
8 members.

METRO ADAM USER'S GROUP

414 W. 149th St., New York, NY, 10031
212-208-0645 * Russell Willis

9am-5pm, M-F

METRO TORONTO AUG

P.O. BOX 123, , ,
*

260 Adelaide St. East,
Toronto, Ontario M5A 1N0

MIDSOUTH ADAM USERS

Lot 142 NAS MHP, Millington, TN, 38053
* Roger Burford

MIKE LAURIER

7350 Roi Rene, , ,
*

366 Anjou, Quebec, Canada H1K

MONTGOMERY USERS GROUP

654 Sarver Av, Montgomery, AL, 36109
* Mike Heurman

MUTUAL ADAM USERS GROUP

412 Bettie St., Akron, OH, 44306
*

NIAD

Box 1317, Lisle, IL, 60532
312-961-3521 * Lyle Marschand

monthly newsletter,
buying service. Dues \$18/yr. P.D.
Library. 1,500 members., 888.

NITTANY ADAM USERS GROUP

R 2, Box 15, Spring Mills, PA, 16875
*

NORFOLK ADAM GROUP

1000 Rockbridge Av #144, Norfolk, VA, 23508
* Jerry Steen

43+ members, PD Library,
No dues, Free technical help, meets
twice a month.

NORTHWEST ADAM USER'S GP

22607 SE 322nd, Kent, WA, 98042
206-886-1167 *

Valorie Zimmerman

OMAHA ADAM USERS CLUB

809 W. 33rd Av., Bellevue, NE, 68005
402-291-4405 * Norman Castro

Meets every 2 mo.
Bellevue Public Library 1003
Lincoln Rd. 60 members, newsletter
Bi-monthly, dues \$20 family/yr,
members receive 300 page
information booklet with access to
100+ programs

OREGON ADAM USERS GROUP

1928 W. Burnside #309, Portland, OR, 97209
* C. Frerichs

Alternate contact, J.
Kahnoski 1606 SE Elliott, Portland
OR 97214.

OUTSIDERS USERS GROUP

122 Cedar Lane, Starkville, MS, 39759
* Donald Villiard

10 members, no
organized meetings, Have PD library,
Newsletter Bi-Monthly, No dues,
Members from all over the world
Only requirement to join is a
sincere desire and willingness to
help other members.

PLAYGROUND AREA AUG

812 Pinedale Rd., Ft Walton Beach, FL, 32548
*

User-Groups

USER-GROUP

PORTLAND AUG

P.O. Box 1081, Portland, OR, 97207
503-241-8173 * Craig Frerichs

24 members, meet 1st
saturday on month, Dues \$1 per
meeting, Test Adam's performance
with data drive speed tape and
consumer diagnostic test. These
and other low cost programs
available through independent
supplier.

PUGET SOUND

22607 SE 322nd, Kent, WA, 98042
206-886-1167 * B. & V. Zimmerman

Meets twice monthly
in private homes, Monthly
newsletter, dues \$5, very complete
P D Library

RICHARD BAINES

7210 Bulen Dr., Anchorage, AK, 99507
*

ROBERT DUNSTAN

95 Harland Crescent, Ajax, ,
*

Ontario, Canada
L1B 1K2
Compuserve ID#75026,3435

ROBERT LENNES

14637 Atlantic, Dolton, IL, 60419
312-841-5776 *

ROBERT MARENTES

9425 N. 38th Ave., Phoenix, AZ, 85021
*

SAN DIEGO ADAM USERS GP

37 Catspaw Cape, Coronado, CA, 92118
* Har. Alexander

SEATTLE-TACOMA ADAM USER

3727-34th Ave. SW, Seattle, WA, 98126
206-938-5276 * Barbara Duncan

THE (717) ADAM USERS

120 E. 4th St., Bloomsburg, PA, 17815
* Steve Chamberla

Steve Chamberlain

TOM RUTAN

1805 14th Ave. N., Texas City, TX, 77590
*

TOM STANHOPE

9539 Clanton, Houston, TX, 77080
713-460-9734 *

TRI-ANGLE ADAM USERS

L-5 Oak Grove, Chapel Hill, NC, 27514
919-968-0299 * Gary Hill

USNH

Box 2844, FPO Seattle, WA, 98778
* David Sandahl

VICTOR L. WATFORD

P.O. Box 777, Russellville, AL, 35653
205-332-6069 *

WINNIPEG AUG

729 Government Ave., Winnipeg, ,
* David Fordyce

Manitoba,
Canada, R2K 1X5

CANADA HOUSING & MORT CORP. ADAM USER GROUP

Jamie Sastre/ 6C Tropicana Priv./
Nepean, Ontario/ CANADA/ K2E 7R8

User Groups
Keep ADAM
Alive !!!!!!!!!!!!!

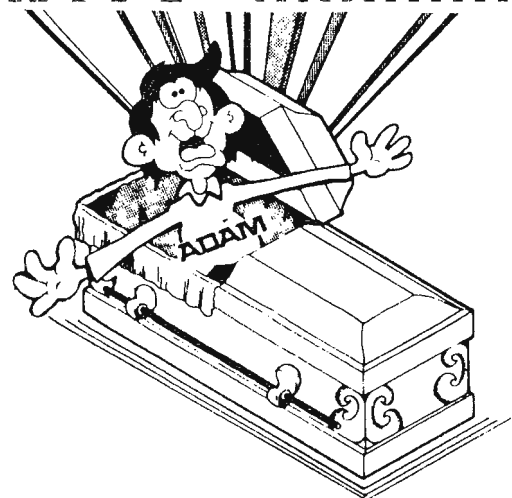

the ADAM Resource
P.O. BOX 30
WELLSVILLE, OHIO 43081



The Adam-User's Section

IN THE NEXT SEVERAL PAGES YOU WILL FIND HUNDREDS OF ADAM USERS LISTED THAT WANT TO BE IN TOUCH WITH OTHER USERS. THIS IS JUST A "DROP IN THE BUCKET" AS TO HOW MANY ADAM OWNERS ARE OUT THERE, BUT WE CAN ONLY PUBLISH THOSE WHO REQUEST US TO DO SO. WE HAVE INCLUDED A CODING OF INTERESTS IN THE LISTINGS. THE NUMBERS IN THE LISTINGS MEAN THE FOLLOWING:

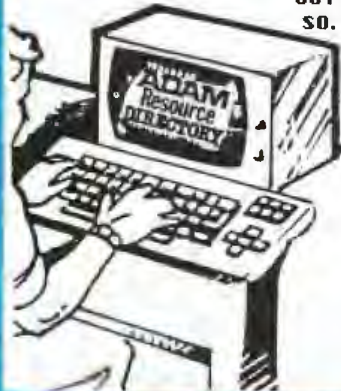

- 1- OWNS A MODEM
- 2- OWNS A DISC DRIVE
- 3- BASIC
- 4- LOGO
- 5- CPM
- 6- MACHINE
- 7- GRAPHIC GAMES
- 8- TEXT GAMES
- 9- EDUCATIONAL
- 10-BUSINESS
- 11-WORD PROCESSING
- 12-UTILITIES



[] ALBARINO, Joe - 3455 Caranbola Cir.6/Coconut Creek, FL / AGE:39 * 1,2,3,5,6,7,9,10,11*

[] ALBERRY, Joseph - /Modesto, CA /209-324-0864 AGE: * 3,7,9,10,11*

[] ANDRESEN, Leonard - 15803 Valley St/Omaha, NE /***-333-1825 AGE:36 * 2,3,4,5,6,7,8,9,10,11*

[] ARCORACI, Dennis - /Alex, VA / AGE:45 * 3,4,9,10,11*

[] AZEVEDO, Frank - 2733 Magnet St./N. Las Vegas, NV 89030/702-870-6640 AGE:38 * 1,3,4,5,6,7,9,12*

[] BADEAUX, Jon - 12115 Magnolia #126/N. Hollywood, CA / AGE: * 1,2,3,4,5,6,7,8,9,10,11,12*

[] BAER, Fred - PO Box 5401/San Mateo, CA 94402/415-345-4114 AGE:45 * 1,2,4,5,7,8,9,10,11,12*

[] BAER, Bridget - 853 Vega Circle/Foster City, CA 94494/415-593-5973 AGE:15 * 1,2,3,4,7,8,9,11*

[] BANAS, Steve - 3603 Katie Dr/C. Bluffs, IA 51901/***-366-1768 AGE: * *

[] BANKS, Sherry - /Ft Belvoir, VA / AGE: * 9,10,11*

[] BARANSKI, John - PO Box 8381/San Diego, CA 92102/ AGE:55 * 9,10,11,12*

[] BARANSKI, Elisa - 2418 California St/Berkeley, CA 94704/ AGE:25 * 9,10,11*

[] BARKER, Scott - 1850 NW 112 Ter./Pembroke Pines, FL 33026/ AGE:16 * 1,3,4,6,8,10,12*

[] BARR, Bud - P.O.Box 81146/Las Vegas, NV 89103/ AGE:48 * 1,2,3,5,6,9,10,11,12*

[] BELEFANT, Arthur - 706 Hackberry Court/Bellevue, NE 68005/402-292-0497 AGE 58 * 3,10,11,12*

[] BELLINETTI, Frank - /Springfield, VA / AGE: * *

[] BELLOTTE, Richard - 19161 Panoramic Dr./Madera, CA 93638/209-673-3465 AGE: * 3,4,7,10,11*

[] BENDER, Hal - 1777Mountain Shadow/Btome Mountain, GA 30087/ AGE: * 1,2,3,5*

[] BENESCH, Kelly - 7952 South 25th St./Omaha, NE 68147/402-734-1148 AGE:22 * 3,4,5,6,7,8,9,10,11,12*

[] BERGER, J.L. - /Alex, VA / AGE: * *

[] BERSANE, John - 615 N. 38th St/C. Bluffs, IA 51501/702-328-1032 AGE:32 * 3,4,5,6,7,8,9,10,11,12*

[] BERSANE, John - 615 North 38th/Council Bluffs, IA 51501/712-328-1032 AGE: * 1,2,3,4,5,6,7,8,9,10,11,12*

[] BIGGS, James N. - 7016 Putt Lane/Fort Wayne, IN 46815/219-485-1802 AGE:35 * 1,2,3,4,5,6,7,8,9,11,12*

[] BINGHAM, Jack - 3641 Autumn Leaves L/Marietta, GA 30064/ AGE: * 3*

[] BIRD, Steven - 12419 South 25th Ave/Omaha, NE 68123/402-292-6591 AGE:37 * 2,3,3,6,7,8,9,10,11,12*

[] BOGGS, Dennis - 15316 Polk Court/Omaha, NE 68137/402-896-0679 AGE:37 * 7,8,9*

[] BONA, Guy B. III - 1824 Wesley Ave./Berwyn, IL 60402/312-484-2850 AGE:28 * 2,3,4,5,7,8,11*

[] BONMAN, Keith - P.O.Box 434/Alexandria, KY 41001/606-635-1816 AGE:32 * 1,2,3,4,5,6,7,8,9,10,11,12* GC/AUG

[] BOTDORF, Mike - 623 B. 153rd Circle/Omaha, NE 68154/402-330-0249 AGE: * 3,5,10*

[] BOYER, George - /St. Petersburg, FL 33708/ AGE:72 * 3,5,6,9,10,11,12* 362 S Boca Ciega Pt BlvdB.

[] BRAMLETT, Richard - 461 Don Circle/Marietta, GA 30064/ AGE: * 3*

[] BRAYMEN, Chris - 58A B. Morrison Ave/San Jose, CA 95126/ AGE:26 * 1,2,3,4,5,6,7,8,9,10,11,12*

[] BRAYMEN, EM. - 1601 Shirley Ave./Los Altos, CA 95126/ AGE: * 7,9,10,11*

[] BROCH, Donald - 340 Royal Ct./Princeton, WV / AGE: * 3,5,7,9,10,11,12*

[] BROWN, William - /Hayettesville, MD / AGE: * 7,8,11*

[] BROWN, Richard - 13547 Currey Lane/Chantilly, VA 22021/ AGE:37 * 1,2,3,5,6,7,8,9,10,12*

[] BRUNING, Shirley - 10833 X St./Omaha, NE /***-339-3317 AGE:45 * 3,4,8,9,10,11,12*

[] BRYANT, Ricky - 1327 Bki Lodge III/Birmingham, AL 35209/ AGE: * 1,2,3,4,5*

[] BRYANT, William - c/o T Kelly 38 R 664/Earlysville, VA 22936/ AGE:32 * 1,2,3,4,5,6,7,8,9,10,11,12*

[] BURD, David - 95 Brookwood Road/Clifton, NJ 07012/201-472-0839 AGE:30 * 1,2,11*

[] BURK, John - 5261 E Teague St./Clovis, CA 93705/209-297-9119 AGE: * 1,3,5,9,10,11,12*

[] BURNS, Johnny - 5681 Tracy Drive/Hableton, GA 30059/ AGE: * 2,3*

[] BURROWS, Keith - Rt. 51 Box 472P/Terre Haute, IN 47805/ AGE:32 * 1,2,3,9,10,12*

[] BUBBY, John II - 6634 BW 41st St/Davie, FL 33314/305-792-6824 AGE: * * Compuserve ID #74726,1056

[] BUTTS, Robert L. - 9418 W. River Rd./Minneapolis, MN 55444/ AGE: * 2,3,4,7,8,11*

[] CARMICHAEL, David E. - 1325 N Meridian #201/Wichita, KS 67203/316-942-1603 AGE:30 * 1,2,3,4,5,7,10,11,12*

[] CASE, Bobby - 124 Filppen Road/Stockbridge, GA / AGE: * 1,2,3,5*

[] CASTLEBERRY, Paul - 5091 Lake Forest Dr./Conyers, GA 30208/ AGE: * 1,2,3,4,5*

[] CASTRO, Norman - 809 W. 33rd Ave/Bellevue, NE 68005/402291-4405 AGE:52 * 1,2,3,4,5,6,7,8,9,10,11,12*

[] CHRISTOPHR, Dennis - 601 NW 42 Ave./Plantation, FL 33317/ AGE:35 * 1,2,3,4,5,6,7,8,9,10,11,12*

[] CONNELLY, Ralph - 7104 86th St #326/LaVista, NE 68128/***-339-0380 AGE: * *



Adam Users

Users



USERS

[] COOKBEY, Ronald - 831 N. San Antonio ./Pomona, CA 91767/ AGE:27 * 1,2,3,4,5,6,7,8,9,10,11,12* Apartment 12D

[] CORTESE, Joe - /Atlanta, GA 30319/ AGE: * 3* 3650 Ashford-Dunwoody RdNE

[] COURTNEY, Lana - 4801 N. Pine St./Davenport, IA 52806/319-391-2730 AGE:44 * 2,3,5,6,7,8,9,10,11,12*

[] CRUMLEY, Dwayne - 689 Birchwood Lane/Marietta, GA 30060/ AGE: * 1,2,3,3*

[] CULPEPPER, Jane - /Atlanta, GA 30328/ AGE: * 2,3* 7340 Twin Branch Rd.NE

[] DANCA, Joseph A. - 794 Normandy #1522/Houston, TX 77015/713-450-1207 AGE: 51 * 1,2,3,6,9,10,11,12*

[] DANIELS, Moon - /Dale City, VA /703-680-2228 AGE:32 * 1,2,3,4,5,6,7,8,9,10,11,12*

[] DANYI, Bruce - 171 N. Yarrow/Oregon, OH 43616/419-693-0033 AGE: * 1,2,3,4,5,6,7,8,9,10,12*

[] DARANET, Michael - 28 Viola St./Winnipeg, / AGE: * 1,3,4,5,7,8,10,12* MB Canada R2V 3B9

[] DAHES, Steven - 6602 North 31st Ave./Omaha, NE 68112/402-457-5080 AGE:28 * 1,2,3,4,5,6,7,9,*

[] DAY, Kerwin - 1420 Mosswood Ln.SE/Bayrna, GA 30080/ AGE: * 1,3,5*

[] DE LA CRUZ, Armando - 11320 BH 156 St./Miami, FL 33157/ AGE: * 1,2,3,4,5*

[] DEL RA, M.W. - 237 N. O Apt C/Tulare, CA 93274/209-688-6391 AGE: * 1,3,5,6,10,11,12*

[] DILLINGER, Mary - 2226 Patterson/Joplin, MO 64801/417-781-9389 AGE:47 * 1,2,3,4,5,7,8,9,10,11,12*

[] DILLINGER, Aml - 2226 Patterson/Joplin, MO 64801/417-781-9389 AGE:47 * 1,2,3,4,5,7,8,9,10,11,12*

[] DOUGHERTY, John P. - 3103 Albert Street/Omaha, NE 68147/402-733-8681 AGE: 44 * 1,3,4,5,7,8,9,10,11,12*

[] DRIESSEL, Berkley - 2555 Homestead Ave/Santa Clara, CA 95051/ AGE:47 * 9,11,12* Apt #18

[] DRIVER, Larry - 4520 Knoll Dr/Dale City, VA 22193/703-520-9059 AGE:44 * 1,3,4,5,6,7,8,9,10,11,12*

[] DUKE, Dean - 712 LLOYD St.Apt D/Fort Walton Bch, FL 32348/ AGE:25 * 3,4,5,6,7,8,9,10,11,12*

[] DUNCAN, Barbara - 3727 34th BW/Seattle, WA 98126/206-938-5276 AGE: * 2,3,7,8,9,10,11,12*

[] EARLEY, Scott - 303 Cabaret Court/Marietta, GA 30064/ AGE: * 1,2,3,4,5*

[] EARLS, Michael - 6499 Sinclair Place/Morrow, GA 30260/ AGE: * 1,2,3,4,5*

[] EDWARDS, Wes. - 2820 Fireside Rd./Chesapeake, VA 23324/ AGE:28 * 1,3,4,5,6,7,8,9,10,11,12*

[] ENRANN, Rick - /Washington DC, / AGE: * 3,4,7,10,11,12*

[] ELLIS, Frank - 19 Eskgrove St./East Brisbane, / AGE:39 * 3,4,5,7,9,10,11* Q.N. Australia time

[] EMERSON, Bill - P.O. Box 298/Hatfield, IN 47617/812-359-5426 AGE:37 * 2,3,9,10,12*

[] ENGLEHART, Mickey - /Baltimore, MD / AGE: * *

[] ESTES, Martin - c/o T Kelly 3B R 664/Earlsville, VA 22936/ AGE:31 * 1,2,3,4,5,6,7,8,9,10,11,12*

[] ESTRADA, Joseph - 4672 Harrison St/Omaha, NE 68157/402-731-0363 AGE:11 * 3,4,7,8,9,10,11,12*

[] FEE, Bill - 729 E.Emerson Ave./Orange, CA 92665/ AGE:63 * 1,2,3,4,5,6,7,8,9,10,11,12*

[] FINNELL, Herb - 12229 Ramsy Lane/Omaha, NE 68123/402-291-4729 AGE:27 * 3,4,5,7,9,10,11,12*

[] FLOTRE, Murray - Box 790/Indian Head, / AGE:39 * 1,2,3,4,5,7,9,10,11,12* Sask, Canada S0G 2K0

[] FORMAN, Jay H. - 510 Rhode Island Ave/Cherry Hill, NJ 08002/609-667-2526 AGE:44 * 1,2,3,4,5,6,7,8,9,10,11,12*

[] FOSTER, Dan - 3504 Vinings N.Trail/Bayrna, GA 30080/ AGE: * 3*

[] FOSTER, Bob - 505 Summerhill Dr.,/Alpharetta, GA 30201/ AGE: * 3,5*

[] FRAZIER, Randy - 4803 B 22nd St/Omaha, NE 68107/402-733-7065 AGE:27 * 3,4,6,7,9,11,12*

[] FREDRICKS, Neal - 3125 Brooklawn Terr./Chevy Chase, MD 20815/ AGE:15 * 1,2,3,4,5,6,7,8,9,10,11,12*

[] FROBT, Grant - 11 Lynwood/Grimby, / AGE:17 * all* Ontario Canada, L3M 2X3

[] FURNAB, Laura - 15029 Chicago Circle/Omaha, NE 68154/402-334-1285 AGE:39 * 3,4,7,9,11*

[] FURBSTEIN, Saul - 2633 Cravey Dr. NE/Atlanta, GA 30345/ AGE: * 3,4*

[] GARNETT, Mary - /Rockville, MD / AGE: * *

[] GAVIO, John - 2441 Hershey Rd/Erie, PA 16509/412-864-0809 AGE: * 1,3,5,6,7,8*

[] GIESLER, Jack - 992 Brackett Rd./NE/Marietta, GA 30066/ AGE: * 3*

[] GILMORE, Thomas C. - 1424 W. 33rd St./Minneapolis, MN 55408/ AGE: * 1,2,3,4,7,8,9,10,11,12*

[] GILMORE, Tom - 3440 Golfview Dr 211/Eagan, MN 55123/ AGE:21 * 1,2,3,4,5,6,7,8,9,10,11,12*

[] GRACE, Hayse - 2306 Hidden Lane/Snellville, GA 30278/ AGE: * 1,2,3,5*

[] GRAMS, Eugene J. - P.O.Box 864/Randolph AFB, TX 78148/ AGE: * 1,2,3,5,6,7,8,10,11,12*

[] GREEN, Mary Kay - 1006 Howard St/Omaha, NE 68102/402-342-4041 AGE: * *

[] GREGORY, Shirley - /Annandale, VA / AGE: * *



Adam
USERS

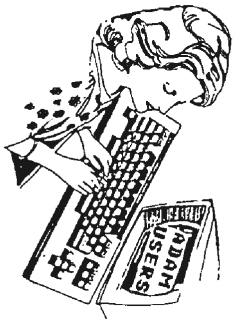

[] GREGORY, Sandy Mr. - 2105 Fisher Tr./N.E./Atlanta, GA 30345/ AGE: * 3,5*

[] GRICKO, Charles - 41 Longview Trail/Denville, NJ 07834/ AGE: * * Also Christopher Gricko

[] GROVES, Richard L. - 520 South 1st St #9/Omaha, NE 68105/402-342-2884 AGE 54 * 1,2,4,5,6,7,8,9,10,11,12*

[] HAGEN, Pat - 4989 Kingswood Dr./Roswell, GA 30075/ AGE: * 3*

[] HAGOOD, Pat - 4451 Custer Street/Hollywood, FL 33024/ AGE:42 * 1,2,3,4,5,6,7,8,10,11*

[] HALELY, Sharon - /, / AGE: * *

[] HALL, John P. - 2849 March Circle/Omaha, NE 68123/402-291-5998 AGE:38 * 3,5,6,7,8,9,10,11,12*

[] HAMMACK, Jim - RT 4/Fairfield, IL 62837/ AGE: * *

[] HARDIN, Tom - 1400 Valley Lake Dr./Riverdale, GA 30296/ AGE: * 1,2,3*

[] HARDTKE, Fred - Rt. 2, Box 552/Rolla, MO 65401/ AGE:53 * 1,2,9,11*

[] HAVACH, George A. - 550 27th St #202/San Francisco, CA 94131/415-285-3007 AGE:42 * 1,2,3,5,6,11,12*

[] HAWKINS, Karen - /Atlanta, GA 30319/ AGE: * 1,2,3* 2229 Drew Valley Rd. N.E.

[] HAYES, Robby - 2470 Morrison Rd.,/Conyers, GA 30208/ AGE: * 1,3*

[] HEIMANN, Dan - 1541 B. 25th St/Omaha, NE 68105/402-342-3217 AGE:35 * 3,4,5,7,8,9,10,11,12*

[] HENDERSHOT, Douglas - /Ft. Belvoir, VA / AGE: * *

[] HENDRICKS, Adrian - 9932 Lindel Lane/Vienna, VA 22180/ AGE:46 * 1,2,3,5,10,11,12*

[] HINTZ, Dan - 7716 Leaf Plum Dr/LaVista, NE 68128/402-339-3129 AGE:26 * 3,4,5,7,8,9,10,11,12*

[] HOLMES, Dennis - /, GA / AGE: * 3*

[] HOOK, Larry - /Alex, VA / AGE: * 1,3,4,7,8,9,11*

[] HOWGED, James - 6541 Va Hills Ave/Alex, VA 22310/ AGE: * 3,4,6,7,9,10,11*

[] HURLEY, Chuck - P.O. Box 81146/Las Vegas, NV 89103/ AGE:38 * 2,3,5,6,7,8,9,11,12* Cobol instructor at collage

[] HURTADO, George - 313 W. Pico Rd./El Centro, CA 92243/619-352-1845 AGE:16 * 1,2,3,5,6,7,8,10,11,12*

[] HUSEMAN, Joseph - 595 Oakstone Dr./Roswell, GA 30075/ AGE: * 3*

[] HYLAND, Larry/Paz - 7524 South 76th St/LaVista, NE 68128/402-339-6165 AGE: 35 * 3,4,7,11*

[] IMDIEKE, Mary Ellen - 1540 128th Ave./Blaine, MN 55434/ AGE: * 3,4,7,8,9,10,11,12*

[] INGERBKY, Don - /Woodbridge, VA /703-441-8218 AGE:32 * 1,2,3,4,5,6,7,8,9,10,11,12*

[] INGRAM, Ed - 1010 Evergreen Ave./Bellevue, NE 68005/402-291-3135 AGE:49 * 3,5,9,11,12*

[] ITSON, William - 4485 Pennwood Ave/Las Vegas, NV /702-367-0970 AGE:26 * 1,3,4,7,9,10,12* Apt. #334

[] JACOBSEN, Steve - 6417 Parkview Lane/Omaha, NE 68104/402-571-1244 AGE:35 * 9,10,11*

[] JACOBSON, Sandra - /Atlanta, GA 30324/ AGE: * 1,2,3,5* 1502 Beechcliff Dr. N.E.

[] JERABEK, Dave - 13436 Spring St/Omaha, NE 68114/402-333-9094 AGE:36 * 3,4,5,7,8,9,11*

[] JESSEN, Linda - 5278 Bunnyside Rd./Mounds View, MN 55112/ AGE: * 3,4,7,8,9,10,11,12*

[] JOHN, Daniel - /New Carlton, MD /301-552-1715 AGE: * 2,3,7,9,11*

[] JOHNSON, Mary Ann - 13124 Burdette Circl/Omaha, NE 68164/402-496-0386 AGE: 37 * 3,4,7,8,9,11*

[] JOHNSTON, David - Box 1042/Claresholm, / AGE:15 * 3,7,8,11* AB Canada TOL OTO

[] KARAWANNY, Paul - 2474 22ND Ave./San Francisco, CA 94116/415-665-0627 AGE: 32 * 1,2,3,4,5,6,7,10,12*

[] KEATING, Bob - 93E/Destin 32541, FL / AGE:70 * 2,3,4,6,9,10,11,12*

[] KEITH, Jack - /Falls Church, VA / AGE: * *

[] KELLY, Thomas J. - 38 Rt. 664/Earlyville, VA 22936/ AGE:42 * 1,2,3,4,5,6,7,8,9,10,11,12*

[] KELLY, Nixie - 3772 Harbor Hills Dr/Largo, FL 33540/ AGE: * *

[] KELTSNER, Allen - 815 Dover Drive/South Bend, IN 46614/219-291-8458 AGE:37 * 1,2,3,5,6,7,8,9,10,11,12*

[] KEMPIK, Paul A. II - 11 B. Porter St./Elgin, IL 60120/312-695-9427 AGE:20 * 1,2,3,4,5,7,8,12*

[] KENNEDY, George - Box 71 Howear Sub./Ruckersville, VA 22968/ AGE:27 * 1,3,4,5,6,7,8,9,10,11,12*

[] Kiessling, Linda - /Alex, VA / AGE: * *

[] KING, Michael V. - 6702 James Lee St./Falls Church, VA 22042/703-241-0540 AGE:29 * 1,2,3,4,5,6,7,9,10,11,12*

[] KING, Karen - /Manassas, VA / AGE: * *

[] KLINGLER, Rodney - 407 E. 11th St/Fremont, NE 68025/402-727-7256 AGE:38 * 2,3,4,5,6,7,8,9,10,11,12*

[] KOWALSKI, Charles - 16005 Bond Mill Rd./Laurel, MD 20707/ AGE: * 1,2,3,4,5,7,9,11,12*

[] L'ITTERAULT, Perry - 61 Cosby Ave/St. Catharines, / AGE: * 2,3,4,5,7,8,9,10,11,12* ON Canada L2M 5R7

[] LAKE, Donald - 6301 Brandywine Way/Las Vegas, NV /702-870-6640 AGE:38 * 2,3,4,5,6,7,8,9,10,12*



Adam Users

USERS



USERS

[] LANDRUM, Dewey - /Marietta, GA 30060/ AGE: +3* 2751 Hammondton Rd. Apt.D-11

[] LANDRUM, Dewey - /Marietta, GA 30060/ AGE: +3* 2751 Hamaandton Rd. Apt.D-11

[] LAUNDRE, T.H. - Rt 2 Box 233/Coldwater, MB 38618/ AGE: + 3,4,5,6,7,8,9,10,11,12*

[] LEE, Mike - P.O. Box 81146/Las Vegas, NV 89103/ AGE:127 * 1,3,5,10,11,12*

[] LEFKO, Richard - 2621 Collier Ave./San Diego, CA 92116/619-543-9269 AGE:31 * 1,2,3,5,7,8,10,12*

[] LEVY, Peter - /Columbia, MD / AGE: * *

[] LIEVBAY, Dwain - 953 Parkside Terr./East Point, GA 30344/ AGE: * 2,3,5*

[] LIPCOMB, David - /Branntown, MD /301-274-3550 AGE: * 3,7,11*

[] LODGE, Bruce - /Snellville, GA 30278/ AGE: * 1,2,3,5* 2503 Crumps Landing Rd.

[] LOGAN, John - 1905 Thurston Av #6/Bellevue, NE 68009/**-292-2373 AGE:28 * 3,4,5,6,7,8,9,10,11*

[] LONG, Robert - 5070 River Glen Dr/Las Vegas, NV 89103/702-873-5939 AGE:33 * 3,4,6,7,8,9,12* Apt #337

[] LOUIS, James - 1540 Hamonton Rd./Marysville, CA 95901/ AGE:31 * 3,4,5,6,7,8,9,10,11,13*

[] LUSBY, Robert - 3402 Albert Rains Av/Omaha, NE 68123/402-292-3506 AGE:40 * 8,9,11*

[] MACCARONI, Ron - /Springfield, VA / AGE: * 3,7,9,11,12*

[] MALONEY, Mark - Box 181/Claresholm, / AGE:15 * 3,4,7,8,12* AB Canada TOL OTO

[] MAR, Gary - 4417 Hartwick/College Park, MD 20740/ AGE:39 * 3*

[] MARLOW, Jason - 115A Hickory Ln./Eglin, FL 32542/904/631/6250 AGE: * *

[] MARLOW, Stanley - 115A Hickory Ln./Eglin, FL 32542/904/631/6250 AGE:40 * 2 3,4,5,7,8,9,10,11,12*

[] MARTIN, Joel - /Plantation, FL 33323/ AGE:64 * 1,2,4,5,6,7,9,10,11,12*

[] MARTIN, Kathy - 1321 Englewood Dr/Bellevue, NE 68005/**-292-3388 AGE: * *

[] MASON, Ralph - /Arlington, VA / AGE: * 2,3,5,6,9,10,11,12*

[] MAXWELL, Michael - /Springfield, VA / AGE: * *

[] MAXWELL, Jernell - 2046 Lyndhurst Rd./Wanesboro, VA 22981/ AGE:30 * 1,2,3,4,5,6,7,8,9,10,11,12*

[] MAZUR, Jon F. - 106A Cedarcrest Apts/Lower Burrell, PA 15068/412-337-1004 AGE:27 * 1,3,4,5,7,8,10,11,12* C.I.B. # 72447,1635

[] MAZZEI, Jim/Mary A - 2705 South 107th St./Omaha, NE 68124/402-397-8179 AGE 36 * 3,7,9,10,11,12*

[] McENTYRE, Roger H. - 5909 Country Ln/Citris Hgts., CA 95621/ AGE:29 * 1,2,3,5,7,8,10,12*

[] McFADDEN, Jim - 205 Beverly Rd., NE/Atlanta, GA 30345/ AGE: * 1,2,3,5*

[] MCINTOSH, Warren - 1774 Attawanderon Rd/London, /519-471-9460 AGE:35 * 1,2,3,4,5,7,10,12* Ontario, Canada N6G 3N1

[] MCINTOSH, Dave - 7 Monsarrat Crescent/London, /519-679-0378 AGE:31 * 1,2,3,4,5,7,10,12* Ontario, Canada N6Y 4Y7

[] MEDINA, Gus - 1154 NW 32nd Court/Miami, FL 33125/ AGE:37 * 1,2,3,4,5,6,7,8,9,10,11,12*

[] MEDINA, Patty - 5002 N.W. 18th PL/Gainesville, FL 32605/904-378-5424 AGE: * * CompuServe ID #72267,756

[] MENSER, Todd - 3124 N 45th St/Omaha, NE 68104/**-455-6088 AGE:15 * 3,4,7,8,9,10,11,12*

[] MILLARD, & Debbie - Box 154-B/Alabama, FL 32548/ AGE: * 3,4,5,6,7,8,9,10,12*

[] MILLER, Jerry - 2902 Ave. D/Co. Bluffs, IA 51501/ AGE: * 3,4,7,9,11*

[] MILLER, Fred - R.R.2 Box 156/Council Bluffs, IA 51501/712-366-2114 AGE:38 * 3,7,8,9,11*

[] MILLER, Collin - /Bethesda, MD / AGE:16 * 7,9,11*

[] MOHAMADI, Saleh - /Fairfax, VA / AGE: * *

[] MOORE, John - 1970 Fisher Tr.,NE/Atlanta, GA 30345/404-633-9701 AGE: * 1,2 3,4,5,6*

[] MORGAN, Kerry - 4904 219th St. S.W./Mountlake Ter., WA 98043/206-774-5997 AGE:20 * 1,2,3,4,5,7,8,10,11,12*

[] MORRIS, Tanya - /Fairmont Hts., MD / AGE: * 7,8,11*

[] MORROW, Jim W. - 5352-B Comman Dr/Eielson AFB, AK 99702/ AGE: * *

[] MORSE, Gordon - 6536 Wright Rd.,NE/Atlanta, GA 30328/ AGE: * 3*

[] MORTENSON, Jeffrey W. - 1128 S Gay Ave #136/Panama City, FL 32404/ AGE:25 * 3,4,5,6,7,8,9,10,11,12*

[] MULDER, Robert U. - 120-3 Turtle Creek/Charlottesville, VA 22901/ AGE:34 * 1,3,4,5,6,7,8,9,10,11,12*

[] MURDOCK, Sherman - Rt. 4 Box36/Dallas, GA 30132/ AGE: * 1,2,3,4,5*

[] MURPHY, Josephine - /Falls Church, VA / AGE:48 * 2,3,5,7,8,11,12* also Tom Murphy, 13

[] MURRAY, Arthur T. - 11033 Greenwood Av N/Seattle, WA 98133/ AGE: * 1,3,6,9 *

[] NATALE, Pat - 19 Mayo/Hurlburt Fld, FA 32544/581-2554 AGE: * *

[] NELSON, Don - 1283 Bramble Rd.,NE/Atlanta, GA 30329/ AGE: * 1,2,3,5*

[] NELSON, Ken - 501 East 100 St./Bloominton, MN 55420/ AGE:21 * 3,4,6,7,8,9,11,12*

[] NETTE, Ken - ATRB 109 MCDEC/Quantico, VA 22134/ AGE:41 * 2,3,9,11*

[] NICHOL, Jim - /College Parke, MD / AGE:33 * *

[] NIEMEYER, Robert - /St. Petersburg, FL 33708/813-391-2154 AGE:63 * 5,9,10,11* 292 Boca Ciega Point Bl.N.



ADAM USERS



[] NIGRA, Margaret M - 3311 Comstock Ave/Omaha, NE 68123/402-292-7475 AGE: * 1,6,10*

[] NOEL, Harry - 8512 Citta Drive/Omaha, NE 68147/402-291-5956 AGE:36 * 3,10,11*

[] NOVAK, Joe - 447 Ridge Court/Roselle, IL 60172/312-529-4521 AGE: * 1,3,7,8,9,10,11,12*

[] OKELBERRY, Bart - 3756 Brentwood St/Las Vegas, NV /702-458-5840 AGE:17 * 1,2,3,4,7*

[] OLDACRE, W.R. - 2 Fenton St./Bedigo, / AGE:30 * 3,4,5,6,7,9,11,12* VIC Australia

[] OLSEN, Peter - 5105 North 38th St./Omaha, NE 68111/402-451-1596 AGE:30 * 3,4,5,6,7,10,12*

[] OLSON, Mark - 31 Fairchild Circle/OAF3, NE 68113/402-291-5956 AGE:29 * 3,4,5,6,7,8,9,10,11,12*

[] ORLIN, Gary - 2662 Rangewood Dr.,/Atlanta, GA 30345/ AGE: * 1,2,3,4,5*

[] OSBORNE, Mike - /Arlington, VA / AGE: * *

[] PACHOLSKI, Mike - 3279 Hascall/Omaha, NE 68105/402-342-2692 AGE:28 * 3,5,7,8,12*

[] PARKERT, David - 3111 Avenue H/Council Bluffs, IA 51501/712-323-8962 AGE: 15 * 3,6,7,8,10,11*

[] PARRISH, Lynn - 5424 N 65 St./Omaha, NE 68104/402-371-4620 AGE: * *

[] PATRICK, Jack - 2145 N. Garden Ave./Fresno, CA 93703/209-251-8804 AGE: * 3,5,10,11*

[] PERKINS, G.R. - 3084 Waterfront Dr./Marietta, GA 30062/ AGE: * 3*

[] POWELL, Wayne - 3056 Juan Drive/Decatur, GA 30032/ AGE: * 3*

[] POWELL, RW. & PL. - 117A Middlesex Dr/Charlottesville, VA 22901/ AGE:28 * 1,3,4,5,6,7,8,9,10,11,12*

[] PROPER, Billy - 449 Scott Blvd./Forest Park, GA 30050/ AGE: * 3,5*

[] PURGLOVE, David - 747 54th St/Oakland, CA 94609/ AGE:19 * 6,7,10,11,12*

[] QUEEN, Mike - PO Box 633/Valley, NE 68064/402-359-2971 AGE: * *

[] QUIGLEY, Jim - P.O. Box 81146/Las Vegas, NV 89103/ AGE:33 * 1,2,3,7,8,9,10,11,12*

[] RAIMONDO, Paul - 8231 NW 67th Ave/Tamarac, FL 33319/ AGE:18 * 1,2,3,5,6,8,9,10,11*

[] RAUSCH, Bob - 407 Cascio Dr/Bellevue, NE 68005/402-291-4234 AGE:37 * 3,9,10,11*

[] REHS, Richard - 2803 Ponderosa Dr./Omaha, NE 68123/402-292-6480 AGE:28 * 1,3,4,5,6,7,8,9,10,11,12*

[] REYNOLDS, Dave - 110 W. Posey/Brazil, IN 47834/(812)448-178 AGE:30 * 1,2,3,4,5,6,7,8,12*

[] REYNOLDS, Bill - Rt. 6, Box 157E/Spartanburg, SC 29303/803-578-2637 AGE:36 * 2,3,4,5,7,8,9,10,11,12*

[] RICCIO, Christy - 2056 Khyber Pass/Bnellville, GA 30278/ AGE: * 3*

[] RICHARDI, James - 4551 E Kinspoint Cir/Dunwoody, GA 30228/ AGE: * 3*

[] RILEY, Deas - 10 Old Geelong Rd./Point Lonsdale, / AGE:35 * 3,4,5,6,8,9,11* VIC, Australia 3225

[] ROBERSON, Bill - 6621 Payton Woods Dr/Tucker, GA 30084/ AGE: * 1,2,3,4,5*

[] ROGINSKY, Al - 4327 Thorndale PL/Las Vegas, NV 89103/702-873-5950 AGE:39 * 1,2,3,5,6,7,8,12*

[] RONELL, Ray - 4751 E Laurite/Fresno, CA 93725/209-252-1709 AGE: * 3,9,10,12*

[] RUSSELL, John - 1220 Rogers Circle/Pittsmt, NE 68048/402-296-3578 AGE: * *

[] SAPPALA, Harvey - 6781 Greengrove Dr./Las Vegas, NV /702-873-8633 AGE:37 * 1,3,4,5,6,7,10,12*

[] SARAGOBA, Frank L. - 7906 Greene Circle/Omaha, NE 68147/402-733-3863 AGE: 48 * 3,6,9,10,11,12*

[] SCARBROUGH, Bob - 11654 Trumble Loop/Omaha, NE 68123/402-291-1211 AGE:37 * 1,2,3,5,10,11,12*

[] SCHLAUTMAN, Larry - RR 5 Box 64J/C. Bluffs, IA 51501/402-322-1939 AGE: * *

[] SCHLIFFKE, Warner F. - 6123 Ruggles St/Omaha, NE 68104/402-451-8267 AGE:42 * 2,3,4,5,6,7,10,11,12*

[] SCHMIDT, Curt - 2150 North T/Fremont, NE 68025/402-721-1551 AGE:18 * 2,3,4,6,7,8,9,10,11,12*

[] SCHNABEL, Warren - Rt. 1, Box 250/Earlysville, VA 22936/ AGE:40 * 2,3,4,5,6,7,8,9,10,11,12*

[] SCHULZE, Dave - 3107 Holly Hill Run/Marietta, GA 30062/ AGE: * 1,2,3,4,5*

[] BEELYE, Bob - 961 Indian Hill Pkwy/Marietta, GA 30067/ AGE: * 3*

[] BERENDNI, Ivan - 3636 Burlington Av N/St. Petersburg, FL 33713/813-327-8339 AGE:37 * 1,3,5,6,7,8,9,10*

[] SHAW, Harold L. - 350 Broken Arrow Ct./Indianapolis, IN 46234/317-271-5873 AGE: * 1,3,5,6,7,9,10,11,12*

[] SHIPLEY, Bruce - 330 Olive Post Rd./Niceville, FL 32578/897-3172 AGE:57 * 2,11*

[] SILVIA, William - 26 Jessie Ave./80. Attleboro, MA 02703/617-761-9296 AGE: * 2,3,4,5,7,8,12*

[] SMARTT, Ginny - /Atlanta, GA 30319/ AGE: * 1,2,3* 2229 Drew Valley Rd., NE

[] SMITH, Harry E. - 48 Scribner Ave./Staten Island, NY 10301/718-981-1351 AGE:63 * 1,2,10,11*

[] SMITH, Phillip W. - 75 Bonner Rd/OffuttAFB, NE 68113/402-292-0391 AGE:33 * 3,4,5,7,9,10,11,12*



ADAM
USERS

USERS



USERS

- [] SMITH, Mike/Paula - 6644 Beine Ave./Highland, CA 92346/ AGE:33 * 1,2,3,4,5,6,7,8,9,10,11,12*
- [] SMITH, Lee - 105 Donna Dr/Terre Hill, PA 17581/ AGE:30 * 1,2,3,4,5,7,8,9,10,11,12*
- [] SMITH, Thomas W. - 13 Spring Lake Ct./St Charles, MO 63303/ AGE: * 1,2,3,4,5,7,8,9,11,12*
- [] SMITH, Quinn G. - 3306 Daniel St./Bellevue, NE 68123/402-291-6373 AGE:60 * 1,2,3,5,9,10,11,12*
- [] SMITH, Wayne - 316 E. El Paso #104/Fresno, CA 93725/209-432-5437 AGE: * 1,2,3,5,10*
- [] SNYDER, Robert - 3960 Flagstone Ct./St. Louis, MO 63033/ AGE:39 * 3,5,7,8,9,10,11,12*
- [] SOPER, Gerald E. - 11965 S. 29th St/Omaha, NE 68005/---291-3193 AGE:39 * 3,5,9,10,11,12*
- [] STANG, Don - 815 Sixth St./Farmington, MN 55024/ AGE:21 * 3,4,6,7,8,9,11,12*
- [] STATON, John - 1302A Bellview Ave/Charlottesville, VA 22901/ AGE:27 * 2,3,4,5,6,7,8,9,10,11,12*
- [] STEGEN, John - /Marietta, GA 30062/ AGE: * 1,2,3,4,5* 3111 Holly Mill Run, NE
- [] STERIN, Heidi - 10006 NW 42 Ave/Pembroke Pines, FL 33024/ AGE:24 * 1,2,3,6,8,9,11*
- [] STEVEN, Karen - 17704 Hill Creek Dr/Derwood, Md 20855/ AGE:49 * 3,8,9,11* Also Barbara Dinsenbacher age 16
- [] STEWART, Ronny - P.O.Box 325/Rialto, CA 92376/ AGE: * 1,2,3,4,5,6,7,8,9,10,11,12*
- [] STRAUB, David - /Arlington, VA / AGE:30 * 3,5,6,9,11* Also Connie Straub
- [] STROUP, Dick - 1123 Rosecrans Ave./Fullerton, CA 92633/ AGE: * 1,2,5,11*
- [] SUDDRETH, Tim - 2774 Beecher Dr. BW/Austell, GA 30001/ AGE: * 3*
- [] SULLIVAN, Chris - 3149 Hampshire Ave,S/St. Louis Park, MN 55426/ AGE:21 * 3,4,6,7,8,9,11,12*
- [] SVARD, Erik - /Marietta, GA 30060/ AGE: * 1,2,3,5* 2969 Hidden Forest Ct.
- [] SWANSTON, Bill - 13535 Fernando Ave./Apple Valley, MN 55124/ AGE: * 3,4,5,6,7,8,9,10,11*
- [] TANIGUCHI, David - 3040 N Delia/Fresno, CA 93705/209-229-5748 AGE: * 1,2,3,4,5,7,8,9,12*
- [] TATUM, Bill - /Falls Church, VA / AGE:55 * 3,4,7,9,11*
- [] TAYLOR, Len - 9909 Pinkney St/Omaha, NE 68134/---571-7331 AGE: * *
- [] TETI, Howard - 1846 Judy Circle/Marietta, GA 30060/ AGE: * 3*
- [] THOMAS, Bonnie - 1409 River View Dr./Madera, CA 93637/209-674-2066 AGE: * 9,10,11*
- [] TIRY, Gaylon - 1402 Pelton Ave/Bellevue, NE 68104/---291-3193 AGE:41 * 3,4,5,6,7,8,9,10,11,12*
- [] TOMPKIN, Bill - RR 3 Box 67/Atlantic, IA 50022/712-243-5119 AGE:56 * 3,5,6,7,10,11,12*
- [] TOWNSEND, Derek - Box 820/Claresholm, / AGE:15 * 1,2,3,4,5,6,7,8,9,10,11,12* Ab Canada Toloto
- [] TUCKER, Elizabeth - 5307 O'Carol St./St. Mountain, GA 30088/ AGE: * 2,3,5*
- [] TURNER, James Jr - 20110 Ave 19/Madera, CA 93637/209-661-8290 AGE:28 * 1,2,3,4,5,6,7,8,9,11,12*
- [] TURNISPEED, David - 4403 Chateau Ct./Dunwoody, GA 30338/ AGE: * 2,3*
- [] TYSON, Jim - 1811 Saint Roman Dr./Vienna, VA 22180/ AGE:44 * 1,2,3,4,5,6,9,10,12*
- [] TZOV, Nolan - /Aldelpal, MD / AGE: * *
- [] ULRICH, Herman - 2117 Lincoln Ave/Pittsath, NE 68104/---296-4185 AGE: * *
- [] VAN EVERA, Jim - 303 N. Queen St./Martinsburg, WV 25401/ AGE: * *
- [] VILLARD, Donald L. - 122 Cedar Lane/Starkville, MS 39759/601-324-2146 AGE: 46 * 1,2,3,4,5,7,8,9,10,11,12*
- [] WADE, H.R. Jr. - 6015 Sprague St/Omaha, NE 68104/402-451-8475 AGE:61 * 11*
- [] WALSH, Al - Box 189/Gretna, NE 68028/---332-3704 AGE: * *
- [] WARREN, Nybo - 128 Patricia Dr./Columbus, MS 39702/601-327-2297 AGE:42 * 1,2,3,4,5,6,10,11,12*
- [] WASHINGTON, Willie - 4419 BW 28th Street/Hollywood, FL 33023/ AGE:38 * 1,2,4,5,6,8,9,10*
- [] HEAD, Sam Jr. - 4323 North 58th St./Omaha, NE 68104/402-451-2752 AGE:47 * 3,4,5,6,7,8,9,10,11,12*
- [] WEBB, Stu - 925 Lumber Exchang/, MN 55402/ AGE: * 3,4,7,8,11*
- [] WEINREIB, Mikka - 12117 Pedersen Dr./Omaha, NE 68114/402-330-2467 AGE:32 * 2,3,6,7,10,11,12*
- [] WENDELL, Don - /Washington DC, /201-291-2717 AGE: * 1,2,3,4,5,6,7,8,9,10,11,12*
- [] WESTCOTT, Vern - 2710 Calhoun St./Bellevue, NE 68005/402-291-3370 AGE:32 * 3,4,7,*
- [] WIGG, Jeff - 6021 Franklin St/Omaha, NE 68104/402-553-0548 AGE:29 * 3,7,8,9,10,11,12,3*
- [] WILSON, Bill - 203 Rackin Hill Dr./Marietta, GA 30060/ AGE: * 1,3,4,5*
- [] WITT, Garry - 18 Arthur Dr./Rochester, IL 62563/217-498-7738 AGE:23 * 3,5,7,8,10,11,12*
- [] WOOD, Stefan - 4229 Leland St/Chevy Chase, MD 20815/ AGE:14 * *
- [] WOOD, Stefan - /Chevy Chase, MD / AGE: * *
- [] WOODRUFF, Gary - RT. 7 Box 224/Frankfort, IN 46041/317/379-2281 AGE:31 * 1,2,3,4,5,7,8,9,10,11,12*
- [] WRIGHT, Walter - 490 17th Street/West Babylon, NY 11704/ AGE:68 * 1,2,3,4,5,6,7,8,9,10,11,12*

[] YAHLE, George - 3110 Johann Ave/Omaha, NE 68123/402-291-6443 AGE:63 * 3,10,11,12*

[] YATES, John - 1200 S Arl. Ridge Rd/Arlington, VA 22202/ AGE: * *

[] ZARUKI, Brian - 3-12 S Livingston/Gretna, / AGE:25 * 1,3,5,6,10,12* Ontario, Canada L3N 4G5

[] ZIMMERMAN, Ryan/Roger - 3329 South 126th St./Omaha, NE 68144/402-334-8342 AGE:34 * 3,4,7,9,10,11,12*

[] ZIMMERMAN, Valerie - 22807 SE 32nd St/Kent, WA 98042/206-886-1167 AGE: * 1,2,3,4,5,7,8,9,10,11,12*

[] ZIMMERMAN, Donald - 5132 Jordan Rd/Silver Springs, NY 14550/716-493-5998 AGE:45 * *

Adam Users



Service Information

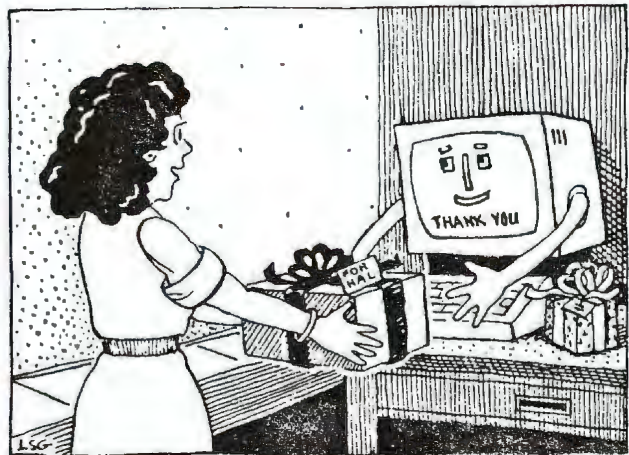

THE CARE & FEEDING OF ADAM

How to effectively maintain your ADAM Computer System

THERE ARE A NUMBER OF THINGS YOU CAN DO FOR YOUR ADAM TO HELP KEEP IT HEALTHY AND LIVE A LONG LIFE. WHILE AT RARE TIMES, YOUR ADAM MAY NEED SERVICING BY A PROFESSIONAL, THE MAJORITY OF THE TIME YOU CAN PERFORM PREVENTIVE MAINTENANCE, THUS KEEPING ADAM OFF THE SICK LIST !

HERE ARE A FEW SUGGESTIONS WE HAVE TO HELP KEEP ADAM UP & RUNNING:

1. KEEP HIM CLEAN - It's very important to keep any computer clean. Dust & dirt is a major enemy. When not in use, keep ADAM covered. There are a number of covers available, or if you have a seamstress in the family, have her make one for you. Periodically use a "dust blower" on ADAM. These come in aerosol cans & are relatively inexpensive. Once in awhile you should clean the heads on your data drive(s). Cleaning kits are available for this. (This is done very similar to cleaning a normal cassette recorder.) If you use high-quality data-packs, your heads will not need cleaning often. It all depends on what & how much you use. Disk drives need to be periodically cleaned as well. (See our special notes on Floppies & Disk drives in this section.) Always wipe ADAM off with a soft dry cloth. NEVER pour water on him! He gets so mad that he sizzles...& he may get mad enough to sizzle you, too!



Service

2. USE A SURGE PROTECTOR - Almost every household has experienced variance in their electric. Sometimes the lights dim or brighten for a few seconds. These surges can be caused by lightning, or other electrical appliances such as a refrigerator or air-conditioner. Spend a few dollars (aprox. \$15) to protect your ADAM from electrical surges. They can do permanent damage!

3. ANTI-STATIC PRODUCTS - Sometimes static electricity can ZAP away your info by erasing a data pack or disk. If you have static problems in your home (most do in the winter time) it may be a good idea to invest in a couple of anti-static products. These consist of sprays, mats, & touch pads which are available at most computer shops.

4. FANNING ADAM - The power supply in ADAM's printer gets very hot when used for long periods of time. There are a number of small computer fans available to help solve this problem. It's also possible to pick-up an additional power supply unit allowing you to program and not have the ADAM printer on, thus saving the life of your ADAM power supply in the printer.

5. WHEN SOMETHING GOES WRONG - If something doesn't seem to be working right, we suggest the following: 1st) Refer to the **Adam System Check-out & Troubleshooting Guide**. This is a several page manual that should have come with your ADAM. Follow its instructions & 75% of the time, you'll find the problem. If there's still a problem, 2nd) Contact a friend with an ADAM & see if you can find the problem area together. Sometimes you can isolate a problem by switching ADAM components to see if it will function after the switch. This is simply a process of elimination. If you feel like there is still a serious problem, then 3rd) Contact your nearest Honeywell Service Center. (All the current Honeywell Centers are listed in this section.) We have found the people at Honeywell to be very helpfull and reasonable in their prices. Of course, if your ADAM is still under warranty, there is no charge.

ADDITIONAL TID-BITS OF INFO ARE INCLUDED IN THIS SECTION. TAKE TIME TO READ THEM. THEY MAY SAVE ADAM'S LIFE & SAVE YOU A FEW BUCKS, (NOT TO MENTION KEEPING YOUR TEMPER UNDER CONTROL)



A Word About DataPacks...

DATA PACKS - Treat data packs with respect & you'll get a lot of use out of them. Never touch the tape. Keep from getting hot. Purchase some type of regular cassette storage case to store your data packs in. Keeping them safe is most important. Do not place them close to magnetic or electrical appliances that might emit magnetic waves. This can seriously damage your data pack. Always carefully insert them in the drive. If you have to force it in, then it's not in there right. Remove it and do it again. If you don't take the time to do this, you'll end up possibly damaging your datapack and end up with an IO ERROR & have to start all over again. Be sure to make back-ups of all your important programs. This is much easier with a second drive unit. (Drive units are easily available at reduced prices.)

DISK DRIVES & FLOPPIES...

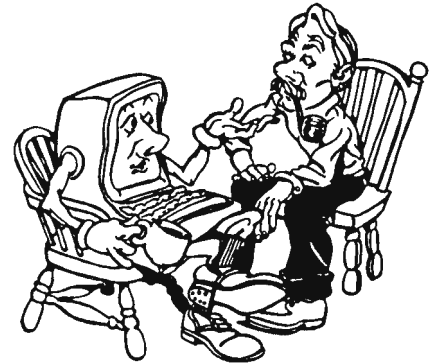

Take Care of Floppies

You will run into all kinds of warnings about how sensitive your floppy disks are to damage. The more you take these warnings to heart, the better. Here's a summary of floppy disk no-nos.

- Never touch the disk surface through the access hole—the elliptically shaped opening in the disk's cover where the actual reading and writing are done.
- Don't expose the disks to excessive heat or cold or to a magnetic field. Motors, telephones, and all sorts of other electrical devices—including your computer's power supply—generate magnetic fields.
- Don't write on your disks, paper-clip them, or otherwise gouge them. If you do, you'll physically damage the disk and, along with it, whatever programs or data were located there.
- Don't leave disks lying around—you are inviting trouble. They'll get dirty, crushed, or knocked onto the floor. They belong in their jackets, stored upright in a container that will keep dust from getting to them.
- Always maintain backup copies of programs and data. No matter how careful you are, something always seems to go wrong with a floppy—usually the one you forgot to back up.

We'll Drink to That

Accidents happen, and chances are that someday you'll spill something on your computer or disks. It may seem relatively harmless—a glass of water, perhaps—but it can damage your equipment in a big way.

You probably already know that water and electricity don't mix, so the first thing you must worry about when you spill something on your computer is the potential for electric shock. Your first action (after you make sure that whatever you spilled has stopped running into your computer) is to unplug everything.

The severity of the incident depends partly on what and how much was spilled. The worst problems come with liquids containing acids—most soft drinks, for example. The carbonic acid in a soft drink is mild, to be sure, but it will do a real number on the metal in your machine. The next biggest problem is with drinks containing sugar. After the liquid dries, the sugar remains, leaving a sticky, scratchy mess that can really foul things up.

Many computer components are hardy enough to withstand a quick dunking. If the liquid spilled was water—even hot water in the form of coffee or tea with no cream or sugar—you can get by with blotting up what liquids you can see, then blowing it dry with a hair dryer or a vacuum cleaner in reverse. Worry a bit about overheating your components with the hair dryer, but getting it dry quickly is more important.

If you spilled a soft drink or some other sticky liquid, you've got to get it off. Probably the safest approach is to try cleaning it with electrical-contact/relay cleaner, although it's rather expensive and may not give you enough liquid to wash things off thoroughly. Another approach is to literally bathe the board with isopropyl (rubbing) alcohol. Be sure it's straight alcohol—no sweet-smelling additives are needed by your computer. Be careful—it's flammable. But it dries quickly and shouldn't cause any real problems. And it's cheaper than electrical contact cleaner and probably more effective.

Disk drives are another problem. If one got drenched, you probably should have it professionally cleaned, lubricated, and realigned. Foreign matter that gets into the drive could cause it to scratch disks.

If you got disks wet, you're probably better off tossing them out and hoping that you've got backup copies. You can try wiping them off, but if moisture or other foreign matter remains, you run the risk of ruining a disk drive when you insert the soiled disk into your machine. If the disks got by with only a sprinkling, let them dry thoroughly (the lining in which disks are housed is absorbent, so let it dry overnight), then try reading one file. If you're successful, copy all the files from one disk to another and throw away the original.

And thank your lucky stars.

Don't Shake Your Head

When you move your computer from one place to another, there's a chance the drive's read/write head can become damaged from bouncing up and down. To avoid such problems, use a "head protection spacer" whenever you move. You can make one easily by cutting a piece of thin cardboard into the shape of a floppy disk. Or use a disk you no longer need.

Behind Closed Doors

If you have single-sided disk drives, keep the disk drive door closed when they're not in use to guard against dust, which can destroy the read/write head. But don't do this if you have double-sided drives. If you shut the door without a disk inserted, the two read/write heads will press together, possibly damaging them. Instead, place a disk you no longer need into the drive, leaving it there with the door shut when the drive is not in use. This will protect the read/write heads from dust and from each other.

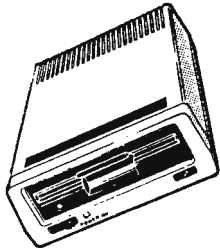

DISK-DRIVE REPAIR...

WE HAVE BEEN INFORMED THAT *EVE ELECTRONICS* AND *ORPHANWARE* SERVICE DISK DRIVES. THEIR ADDRESSES ARE LISTED IN THE RETAILERS SECTION.

NOTE: HONEYWELL ALSO SERVICES DISK DRIVES

HONEYWELL SERVICE CENTERS

THE FOLLOWING IS A CURRENT LISTING OF THE HONEYWELL SERVICE CENTERS ACROSS THE COUNTRY. ALL LOCATIONS PROVIDE WALK-IN SERVICE ONLY EXCEPT: * DENOTES WALK-IN & MAIL-IN SERVICE.

ARIZONA

Phoenix (602) 862-3577
5115 North 27th Avenue
M/S K76
Phoenix, AZ 85017

* CALIFORNIA

Los Angeles Area
(714) 956-6000 ext. 6036
405-A North Muller
Anaheim, CA 92803

Los Angeles Area
(213) 533-8618
20600 Gramercy Place
Torrance, CA 90501

San Diego (619) 576-9231
3860 A Calle Fortunada
San Diego, CA 92123

San Jose (408) 433-3076
4145 N. First Street
San Jose, CA 95134-1594

COLORADO

Denver Area (303) 792-1404
304 Inverness Way South
Suite TL-2
Englewood, CO 80112-5818

FLORIDA

Miami (305) 592-5293
8685 NW 53rd Terrace
Suite 106
Miami, FL 33166

Tampa Area (813) 576-1338
9721 Executive Center Drive
Suite 122
St. Petersburg, FL 33702

GEORGIA

Atlanta (404) 982-2320
2801 Buford Highway
Suite 132
Atlanta, GA 30329

HAWAII

Honolulu (808) 836-2905
550 Paiea Street
Suite 205
Honolulu, HI 968199

ILLINOIS

Chicago Area
(312) 671-1800 ext. 507
4849 North Scott Street
Suite 101
Schiller Park, IL 60176

LOUISIANA

New Orleans Area
(504) 456-7217
6620 Riverside Drive
Metairie, LA 70003

MARYLAND

Baltimore Area (301) 636-2005
801-A Barkwood Court
Lithicum, MD 21090

* MASSACHUSETTS

Boston Area (617) 923-7695
3 Newton Executive Park
Newton Lower Falls, MA 02162

* MICHIGAN

Detroit Area (313) 548-3550
338 East Twelve Mile Road
Madison Heights, MI 48071

MINNESOTA

Minneapolis Area
(612) 830-3899
7300 Metro Blvd.
Edina, MN 55435

MISSOURI

St. Louis Area (314) 576-2606
12144 Lackland
Creve Coeur, MO 63146

NEW JERSEY

Fairfield (201) 575-7695
264 Passaic Avenue
Fairfield, NJ 07006-2591

NEW YORK

Long Island Area
(516) 334-1199
55 South Service Drive
Jericho, NY 11753

New York City (212) 512-0671
Two Penn Plaza
Suite 1100
New York, NY 10121

Rochester (716) 424-2700
100 Metro Park
Rochester, NY 14623

OHIO

Cincinnati (513) 745-7375
4350 Malsbury Road
Cincinnati, OH 45242

Cleveland Area (216) 459-6281
925 Keynote Circle
Brooklyn Heights, OH 44131

Columbus (614) 486-9664
1393 Dublin Road
Columbus, OH 43215

PENNSYLVANIA

Philadelphia Area
(215) 839-6648
1 Bala Plaza
Bala Cynwyd, PA 19004

Pittsburgh (412) 928-4337
5 Foster Plaza Bldg.
651 Holiday Drive, 2nd Floor
Pittsburgh, PA 15220

TENNESSEE

Memphis (901) 345-6222
2598 Corporate Drive East
Memphis, TN 38132

TEXAS

Dallas Area (214) 241-6046
13239 Valley Branch Lane
Farmer's Branch, TX 75234

Houston (713) 957-7530
4501 South Pinemont
Suite 108
Houston, TX 77041

VIRGINIA

McLean (703) 749-2086
1766 Old Meadow Lane
McLean, VA 22102

Norfolk Area (804) 461-0219
1801 L Sara Drive
Chesapeake, VA 23320

WASHINGTON

Seattle Area (206) 575-0404
636 Industry Drive
Tukwila, WA 98188

WISCONSIN

Milwaukee Area
(414) 784-6260 ext. 403
150 North Sunnyslope Road
Brookfield, WI 53008-0945



HONEYWELL'S MAIN OFFICE ADDRESS IS: 141 Needham St./Newton Highlands/ Massachusetts 02161/(617)552-6000

**The ADAM
Resource File**
SECURITY, ADAM 2000

The Online Section



ONCE YOU CONNECT YOUR ADAM TO A PHONE LINE, YOU OPEN UP AN ENTIRE NEW WORLD OF INFO. IN THE PAGES AHEAD WE PROVIDE THE INFORMATION YOU NEED TO GET STARTED. INCLUDED ARE TIPS, ADAM BBS's, DATABASE INFO, GENERAL BBS's, & ONLINE PUBLICATIONS.



***COMPUERVE

INFORMATION***

IF YOU SUBSCRIBE TO COMPUERVE, THERE ARE TWO ON-LINE AREAS FOR ADAM USERS. AFTER LOGGING-ON - GO FAN 200 (SECTION (6)ADAMANIA) FOR THE FAMILY COMPUTING FORUM, OR GO PCS 22 FOR THE CREATIVE COMPUTING FORUM (SECTION (8)EVEN ADAM) BOTH FORUMS HAVE EXTENSIVE ADAM MESSAGE BASES AND (DL)DATA LIBRARIES WITH HELPFUL INFORMATION. TO ACCESS COMPUERVE YOU'LL NEED A STARTER KIT WHICH WILL GIVE YOU 3-HOURS OF TIME ON THE SYSTEM. IT IS POSSIBLE IN MOST LARGER CITIES TO ACCESS COMPUERVE THROUGH A LOCAL MANDER, SAVING LONG-DISTANCE CHARGES. COMPUERVE IS PROBABLY THE BIGGEST SYSTEM IN OPERATION TODAY. YOU NEED TO DO A LOT OF READING AHEAD OF TIME TO GET THE MOST OUT OF THE SERVICE. AVERAGE COST IS \$4-\$8 PER HOUR.



GENERAL TIPS FOR USING COMPUTER BULLETIN BOARDS

1. COMMUNICATIONS SETTINGS:

BOOT IN YOUR ADAMLINK PROGRAM AND SET YOUR PARAMETERS ACCORDING TO THE INSTRUCTIONS THAT PARTICULAR BOARD GIVES. IF YOU CANNOT ACCESS THE BOARD CORRECTLY, CHANCES ARE YOU HAVE MADE IMPROPER SETTINGS. GO BACK & START OVER IN SUCH A CASE, CHECK YOUR SETTINGS, MAKE NECESSARY CHANGES, THEN TRY AGAIN.

2. HOURS OF OPERATION

MOST BOARDS OPERATE 24 HOURS SO IT'S OK TO CALL ANYTIME. IF THE BOARD DOES NOT OPERATE 24-HOURS, YOU PROBABLY SHOULD NOT CALL THE BOARD ANY EARLIER THAN 6:00 PM IN ITS LOCAL TIME-ZONE. 8:00 PM WOULD BE EVEN SAFER.

3. OFF THE AIR:

IF A BOARD DOES NOT ANSWER AFTER TWO OR THREE RINGS, IT IS FOR SOME REASON OUT OF COMMISSION, POSSIBLY FOR GOOD OR FOR REPAIRS. HANG-UP AFTER 2-3 RINGS. MANY LONG-DISTANCE SERVICES NOW CHARGE YOU FOR A CALL EVEN IF IT IS NOT ANSWERED AFTER THREE RINGS. HANG-UP & SAVE MONEY!

4. WHO CAN YOU TALK TO?

YOU CAN TALK TO ANY BOARD USING YOUR ADAM. YOU SIMPLY NEED TO MAKE THE PROPER SETTINGS AND FOLLOW PROPER LOG-ON PROCEDURES FOR THAT PARTICULAR BOARD. IT IS ADVISED TO DOWNLOAD THE INSTRUCTIONS OFFERED WHEN YOU FIRST LOG-ON TO A SYSTEM, THAT WAY YOU WILL HAVE ALL THE INFO AT YOUR FINGERTIPS FOR FUTURE REFERENCE. REMEMBER...IF YOU ARE CONSTANTLY CALLING FOR THE "HELP" FILE YOU'RE GOING TO TAKE A LOT OF TIME AS WELL AS MONEY OUT OF YOUR POCKET.

5. BE CONSIDERATE

MOST SYSDOPS WANT YOU TO USE THEIR SYSTEM...AND YOU OF COURSE NEED TO TAKE EXTRA TIME AT FIRST TO LEARN THAT PARTICULAR SYSTEM....HOWEVER....DON'T FORGET THAT OTHER PEOPLE WANT TO USE THE SYSTEM TOO! AND IF IT'S LONG DISTANCE...LOOK OUT! TIME FLIES WHEN YOU ARE ON-LINE, SO DON'T FORGET TO KEEP AN EYE ON YOUR TIME CONNECT DISPLAY AT THE BOTTOM OF THE SCREEN.

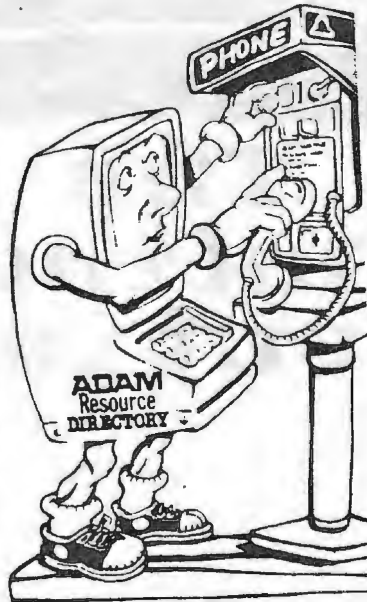

TELECOMMUNICATIONS SOFTWARE FOR ADAM

THERE ARE SEVERAL PIECES OF SOFTWARE THAT WORK WITH THE ADAM THAT ARE AVAILABLE. HERE IS A QUICK SUMMARY OF WHAT'S OUT THERE:

1. **ADAMLINK I & II** - The ADAMLINK Software comes with the ADAMLINK MODEM. Be sure you have the 2nd version of ADAMLINK (It's called ADAMLINK II) Only this version allows you to "upload" & "download". If you have the old version, check with one of the user groups listed in this directory & find someone to update yours.

2. **MABAM 7 & MEX** - These are software packages in the CP/M format which have been configured to work with ADAM's internal modem. They are available as public domain programs. If you are unable to obtain a copy, you can do so by sending \$5.00 for each program you want on disk to: Joe Blanke, PO BOX 41746, Sacramento, CA 95384. He has a number of PB programs available. Request the latest list by sending an SASE.

3. There are also a couple of PB Bulletin Board programs around. This is what you would use if you want to set your ADAM up to actually run a BBS. Your group may want to set one up for members. For latest info, contact the above or the ADAM RESOURCE.

DATABASE & SERVICE LISTING

BRS
Bibliographic Retrieval Services
1200 Rte. 7
Latham, NY 12110
(800) 833-4707
BRS/AFTR DARK
Bibliographic Retrieval Services
1200 Rte. 7
Latham, NY 12110
(800) 833-4707
C.A.R.O.L.
Computer Assisted Research
On Line
Bob Sherman
1166 N.E. 182 St.
North Miami Beach, FL 33160
(305) 944-2111
CHASE ECONOMETRICS
Chase Econometrics/Interactive
Data Corporation
486 Totten Pond Rd.
Waltham, MA 02154
(617) 890-1234

CITISHARE CORPORATION
850 3rd Ave.
New York, NY 10043
(212) 572-9605
COLLECTOR'S DATA SERVICE
430 West Mercer
Seattle, WA 98119
(800) 435-0100
(206) 281-7273 in Washington
COMPUSERVE
Consumer Information Service
5000 Arlington Center Blvd.
P. O. Box 20213
Columbus, OH 43220
(800) 848-8199
in Ohio
(614) 457-0803
DELPHI
General Videotex Corporation
3 Blackstone St.
Cambridge, MA 02139
(617) 491-3393



DOW JONES NEWS/RETRIVAL
Dow Jones and Company, Inc.
P. O. Box 300
Princeton, NJ 08540
(800) 257-8114
(609) 452-1511 in New Jersey
E-COM
United States Postal Service
call your local Post Office
EDNET
National Education
Corporation
315 Post Rd.
Westport, CT 06880
(203) 227-0891
ENIS
Electronic Information
Exchange System
Computerized Conferencing
and Communications Center
323 High St.
Newark, NJ 07102
(201) 548-8221

ELECTRONIC UNIVERSITY
TeleLearning Systems, Inc.
505 Beach St.
San Francisco, CA 94133
(415) 928-2800
THE ELECTRIC PAGES
P. O. Box 2550
Annetta, VA 78768
(512) 472-6432

THE INFORMATION BANK
New York Times Information
Service
1719A-Route 10
Paraply, NJ 07054
(201) 839-6850
(212) 683-2306 in New York
(793) 243-7280 in Washington, DC.
(312) 236-6800 in Chicago
(415) 822-2600 in San Francisco
(213) 852-7003 in Los Angeles
(713) 965-9371 in Houston
(416) 598-8250 in Toronto
KNOWLEDGE INDEX
Dialog Information Services,
Inc.
3460 Hillview Ave.
Falo Alto, CA 94304
(800) 227-8510
(415) 858-3796 in California
(800) 227-1927 (Dialog)

THE ELECTRONIC EDITION
Official Airlines Guides, Inc.
2000 Clearwater Dr.
Oak Brook, IL 60521
(312) 654-6000
HAM RADIO NETWORK
Chesapeake Microcomputer
Club
Joe Kaaser, President
11532 Stewart Ln.
Silver Spring, MD 20904
ITT DIALCOM
ITT Dialcom, Inc.
1109 Spring St.
Silver Spring, MD 20910
(301) 588-1872

MCI MAIL
(800) 323-7751 to register by
computer
(800) MCI-2255 for information
NEWSNET
945 Haverford Rd.
Bryn Mawr, PA 19010
(800) 345-1901
(215) 527-8030
NITS-LINE
National Computer Network
1929 Harlem Ave.
Chicago, IL 60635
(312) 622-6666
ORBIT
SDC Information Services
2500 Colorado Ave.
Santa Monica, CA 90406
(800) 421-7229
(800) 352-6689 in California
PARTICIPATE
Participation Systems, Inc.
43 Myrtle Ter.
Winchester, MA 01890
(617) 729-1976
PLATO
Control Data Corporation
Call the CDC office nearest
you, or
Missneapolis, MN
(800) 328-1109

SEARCHMART
Searchmart Corporation
636 U.S. Highway 1, Suite 210
North Palm Beach, FL 33408
(305) 845-2996

THE SOURCE
Source Telecomputing
Corporation
1616 Anderson Rd
McLean, VA 22102
(800) 336-3366
(703) 734-7540 in Virginia
TELENET
GTE TeleNet
8229 Boone Blvd.
Vienna, VA 22180
(703) 827-9565
(800) 336-0437
(800) 572-0406 in Virginia
TYMNET
Tymanet, Inc.
30705 Valley Green Dr.
Cupertino, CA 95014
(408) 446-6236
(800) 336-0149 in the East
(800) 323-7389 in the West
WESTERN UNION EASYLINK
(800) 336-3797 ext. 108
(703) 448-8877 ext. 108 in
Virginia

PUBLICATIONS & DIRECTORIES OF ON-LINE SERVICES

COMPUTER-READABLE DATABASES:
American Society for
Information Science
1010 16th St. NW
Washington, DC 20036
(202) 689-3644
COMPUTER-READABLE DATABASES:
A DIRECTORY AND DATA SOURCEBOOK
Knowledge Industry
Publications, Inc.
701 Winchester Ave.
White Plains, NY 10604
(914) 328-9157
DATACAST
Wireless Digital, Inc.
345 Sweet Rd.
Woodside, CA 94062
(415) 851-2614
DATAPRO DIRECTORY OF ON-LINE SERVICES
Delnet Research Corporation
1805 Underwood Blvd.
Delran, NJ 08075
(609) 764-0100

DIRECTORY OF FEDERAL STATISTICAL DATA FILES
National Technical Information
Service
5285 Port Royal Rd.
Springfield, VA 22161
(804) 467-4600
DIRECTORY OF ONLINE DATABASES
Cuadra Associates, Inc.
2001 Wilshire Blvd., Suite 305
Santa Monica, CA 90403
(213) 829-9972

ELECTRONIC MAIL & MESSAGE SYSTEMS (EMMS)
International Resource
Development
30 High St.
Norwalk, CT 06851
(203) 866-6914

ENCYCLOPEDIA OF INFORMATION SYSTEMS AND SERVICES
Gale Research Company
Book Tower
Detroit, MI 48226
(313) 961-3243
INFORMATION INDUSTRY MARKETPLACE
R.R. Bowker and Company
1180 Sixth Ave.
New York, NY 10036
(212) 764-5100

INFORMATION SOURCES
Information Industry
Association
316 Pennsylvania Ave. SE
Suite 400
Washington, DC 20003
(202) 544-1969
MICROCOMPUTER INFORMATION SUPPORT TOOLS (MIST)
Peter and Trudy Johnson-Lanz
695 Fifth St.
Lake Oswego, OR 97034
(503) 638-2615
ONLINE and DATABASE
Online, Inc.
11 Thayer Ln.
Weston, CT 06883
(203) 227-8466
THE ON-LINE COMPUTER TELEPHONE DIRECTORY
J. A. Casbron Company, Inc.
P. O. Box 10005
Kansas City, MO 64111
(816) 756-1847
CompuServe 70040.414

OTHER NETWORKS
P. O. Box 14066
Philadelphia, PA 19123
SPACE RESEARCH NEWSLETTER
Steven K. Mayer
P. O. Box 803
State College, PA 16801
(814) 238-2275
Delight: SPACEMAN
VIDEOPRINT
International Resource
Development
30 High St.
Norwalk, CT 06851
(203) 866-6914

ON-LINE BOOKS

The Complete Handbook of Personal Computer Communications
by Alfred Gloasbrenner
St. Martin's Press
New York, NY 1983
The Computer Phone Book
by Mike Cane
New American Library, 1983
(Updates available from:
Mike Cane
The Computer Phone Book
175 Fifth Ave., Suite 3371
New York, NY 10010)
Hooking In
by Tom Beeston & Tom Tucker
ComputerFood Press
Westlake Village, CA
1983
How to Create Your Own Computer Bulletin Board
by Larry L. Myers
TAB Books, Inc.
Blue Ridge Summit, PA
1983
The Network Nation: Human Communication via Computer
by Murray Turfitt and Starr
Kamman Hillis
Addison-Wesley
Reading, MA
1978
The Network Revolution: Confessions of a Computer Scientist
by Jacques Vallee
And/Ov Press, Inc.
Berkeley, CA
1982

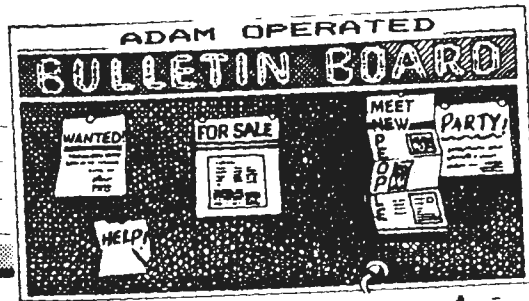

Adam BBS Listing

- *****
- THE ADAM/LINK BBS (San Francisco).....24 hours
(415) 346-3799
 - THE ADAM SmartLINK (Atlanta).....24 hours
(404) 424-6258
 - THE ADAM HOTLINE 2.2 (Upstate New York).....24 hours
(716) 773-4532
 - ADAM HOTLINE COMPUTER BBS (California).....7-7 Daily
(818) 761-1561
 - ADAM-A-CHANGE (Cobra BBS-New York).....24 hours
(315) 594-9372
 - THE ADAM INFO EXCHANGE (Dallas,GA.).....24 hours
(404) 445-8785 (write to Sherman Murdock/Rt.9Box 36/Dallas,GA
30132-for details)
 - THE BREAD BOARD (Arkansas).....24 hours
(501) 442-8777
 - TONY'S CORNER (Detroit).....24 hours
(313) 754-1131
 - CITADEL BBS (Sacramento, CA).....24 hours
(916) 338-2352
 - YOUR AVERAGE REMOTE (Los Angeles).....24 hours
(213) 325-0213
 - WEBER STATE COLLEGE BBS (Utah).....4:30PM-7:30AM MST
(801) 626-7906
 - MICROWAVE BBS (Kentucky).....24 hours
(606) 249-6291
 - THE COMPUTER STOP BBS (Arizona).....24 hours
(602) 249-6291
 - PLANET EARTH (San Francisco).....24 hours
(415) 968-7728
 - THE BOARD (Massachusetts).....24 hours
(617) 881-6349
 - REMOTE ACCESS CP/M BBS (Southern California).....24 hours
(213) 325-0213
 - TORONTO ADAM-NET (Canada).....24 hours
(416) 594-2841
 - SEACOM-80 (Seattle).....24 hours
(206) 768-8879
 - TABOIS CONSOLE BBS (Maine)...Sat & Sun 8PM to 12AM EST
(207) 929-8286 Man,Wed,Fri 6PM to 10PM EST
 - STEEL CITY BBS (Ohio).....24 hours
(216) 244-9081
 - DAKOM New Jersey).....24 hours
(201) 842-7644
 - TOWER OF ZOT (Rochester, NY).....24 hours
(716) 833-0316

General Bulletin Boards

HERE IS A COLLECTION OF BBS'S THAT ARE NOT ADAM-RUN BOARDS, HOWEVER, IT IS STILL POSSIBLE FOR ADAM TO "TALK" TO ANY BRAND OF COMPUTER. A WEALTH OF INFORMATION CAN BE PICKED UP ON BOARDS, SO LOOK THROUGH THIS LIST & SEE WHAT YOU MAY BE INTERESTED IN. CHANCES ARE, THERE ARE BOARDS IN YOUR OWN LOCAL DIALING AREA. GIVE THEM A CALL...YOU MIGHT LEARN SOMETHING. (NOTE: IF YOU CALL A BOARD & YOU GET NOTHING BUT "GARBAGE" ON THE SCREEN, CHANGE YOUR PARAMETER SETTINGS AND CALL AGAIN.)

Regular updates of this list may be found on
CompuServe MAUG XA4, The Source PUBLIC 112,
and most participating independent P.M.S. systems.

- * denotes 24-hour operation
- + denotes 8-12 hour DAYTIME operation ONLY
- denotes 8-12 hour NIGHTTIME operation ONLY
- ! new system or new number to existing system
- \$ Supports VADIC 1200 baud operation
- & Supports 212A 1200 baud operation
- % Supports BAUDOT operation
- #1 denotes original system of that type
- dd. denotes game oriented messages
- dl. download/program exchange system
- ml. mail/information exchange only
- rb. denotes call, let ring once and call back
- rl. religious orientation
- so. sexually oriented messages

ABBS AGS, Atlanta, GA (404) 733 3461*
 ABBS Akron Digital Group, Akron, OH (216) 745 7855*
 ABBS Apple Crate I, Seattle, WA (206) 935 9119
 ! new system or new number to existing system
 \$ Supports VADIC 1200 baud operation
 & Supports 212A 1200 baud operation
 % Supports BAUDOT operation
 #1 denotes original system of that type
 dd. denotes game oriented messages
 dl. download/program exchange system
 ml. mail/information exchange only
 rb. denotes call, let ring once and call back
 rl. religious orientation
 so. sexually oriented messages
 ABBS Apple Crate II, Seattle, WA (206) 244 5438
 ABBS Apple-Med, Iowa City, IA (319) 353 6528
 ABBS Apple-Mate, New York, NY (201) 864 5345
 ABBS Baileys Computer Store,
 Augusta, GA (404) 790 8614
 ABBS Baton Rouge, LA (504) 291 1360
 ABBS Byte Shop, Ft. Lauderdale, FL (305) 486 2983
 ABBS Byte Shop, Miami, FL (305) 261 3639
 ABBS Calvary Mission Church,
 Mnpis, MN (612) 472 3985*rl.
 ABBS CCNJ, Pompton Plains, NJ (201) 835 7228
 ABBS Charlotte, NC (704) 364 5245*
 ABBS CODE, Glen Ellyn, IL (312) 882 2926*
 ABBS Colortron Computer, Racine, WI (414) 637 9990*
 ABBS Compumart, Ottawa,
 Ontario, Canada (613) 725 2243
 ABBS Computer Corner, Amarillo, TX (806) 355 5610
 ABBS Computer Conspiracy,
 Santa Monica, CA (213) 829 1140
 ABBS Computer Crossroads,
 Columbia, MD (301) 730 0922
 ABBS Computer Lab, Memphis, TN (901) 761 4743
 ABBS Computer Room, Kalamazoo, MI (616) 382 0101
 ABBS Computer Store, Toledo, OH (419) 531 3845
 ABBS Dallas Info Board (214) 248 4539
 ABBS Denver, CO (303) 759 2625
 ABBS Detroit, MI (313) 477 4471
 ABBS Fort Walton Beach, Destin, FL (904) 243 1257
 ABBS Gamemaster, Chicago, IL (312) 475 4884*
 ABBS Illini Microcomputer, Naperville, IL (312) 420 7995
 ABBS Ketchikan, AK (907) 225 6789
 ABBS Michigan Apple-Pone, Southfield, MI (313) 357 1422
 ABBS Nessy Game System, Itasca, IL (312) 773 3308*
 ABBS Nessy Flynn's BBS, Crystal Lake, IL (815) 455 2406
 ABBS Omaha, NE (402) 339 7809
 ABBS Pacific Palisades, Los Angeles, CA (213) 459 6400
 ABBS Peoria, IL (309) 692 6502
 ABBS Phoenix, AZ (602) 898 0891
 ABBS Pirates Cove, Long Island, NY (516) 698 4008
 ABBS Rogers Park, Chicago, IL (312) 973 2227
 ABBS Software Sorcery, Herndon, VA (703) 471 0610
 ABBS South of Market, San Francisco, CA (415) 469 8111 so.
 ABBS The Pulse, Dallas, TX (214) 631 7747*so
 ABBS Teledunjon I, Dallas, TX (817) 469 1626
 ABBS Teledunjon II, Dallas, TX (214) 530 0858
 ABBS Teledunjon III, Dallas, TX (214) 960 7654
 ABBS Turnersville, NJ (609) 228 1149
 ABBS Vancouver, B.C. (604) 437 7001
 ABBS Vermont, Essex Junction, VT (802) 879 4981*
 ABBS Video Adv. Movie Marquee,
 Evanston, IL (312) 475 5282
 ABBS West Palm Beach, FL (305) 848 3802
 ABBS Youngs Elect Svc.,
 College Station, TX (713) 693 3462*
 ABBS #X, Atlanta, GA (404) 256 1549
 ACS Arlington Heights, IL #1(312) 392 2403
 ACS Chicago (312) 445 1130

A-C-C-E-S-S Annapolis, MD (301) 267 1666*
 A-C-C-E-S-S Olympia, WA (206) 866 9043*
 A-C-C-E-S-S Phoenix, AZ (602) 275 6644
 A-C-C-E-S-S Phoenix, AZ #1(602) 996 9709*
 A-C-C-E-S-S Phoenix, AZ &(602) 957 4428*
 A-C-C-E-S-S Phoenix, AZ (602) 274 5964
 A-C-C-E-S-S Scotsdale, AZ (602) 998 9411*
 A-C-C-E-S-S Wyckoff, NJ (201) 891 7441*
 AMIS A.R.C.A.D.E. Sterling Heights, MI (313) 978 8087*
 AMIS Clarendon Hills, IL (312) 789 3610*
 AMIS APOGEE Miami, FL (305) 238-1231 rb.
 AMIS GRAFEX Cupertino, CA (408) 253 5216
 AMIS G.R.A.S.S. Grand Rapids, MI (616) 241 1971*
 AMIS IBBS San Jose, CA (408) 298 6930
 AMIS M.A.C.E. Detroit, MI #1(313) 868 2064*
 AMIS Magic Lantern, Madison, WI (608) 251 8538
 AMIS Starbase 12 Philadelphia, PA (617) 876 4885
 AMIS T.A.B.S. Sunnyvale, CA (408) 942 6975
 AE-PRO DSI
 Lakeside, CA (pwd=DATEL) (619) 443 6616 dl.
 ARMUDIC Washington, DC #1(202) 276 8342
 ARMUDIC Computer Age, Baltimore, MD (301) 587 2132
 BBS IBM Hostcomm Atlanta, GA (404) 252 4146
 BBS IBM Hostcomm Fairfax, VA (703) 978 9592*
 BBS IBM Hostcomm Fairfax, VA (703) 978 0921*
 BBS IBM Hostcomm Fairfax, VA (703) 591 5120*
 BBS IBM Hostcomm Fairfax, VA (703) 425 9452*
 BBS IBM Hostcomm Springfield, VA (703) 425 7229*
 BBS IBM Hostcomm Houston, TX (713) 890 0310*
 BBS IBM Hostcomm Toronto, Ontario, CN (416) 499 7023*
 BBS IBM PC Annandale, VA (703) 560 0979*
 BBS IBM PC Atlanta, GA (404) 294 6879
 BBS IBM PC Atlanta, GA (404) 252 9438*
 BBS IBM PC Beltsville, MD (301) 937 4339*
 BBS IBM PC Bethesda, MD (301) 460 0538*
 BBS IBM PC California Users Group (805) 987 4127*
 BBS IBM PC Carlote, NC (704) 365 4311*
 BBS IBM PC Computer Society,
 Boston, MA ! (617) 353 9312-
 BBS IBM PC Culver City, CA &! (213) 649 1489*
 BBS IBM PC Niles, IL (312) 991 8887*
 BBS IBM PC Dale City, VA (703) 680 5220*
 BBS IBM PC Gaitersburg, MD (301) 251 6293*
 BBS IBM PC Madison, WI (608) 262 4939*
 BBS IBM PC New York, NY (201) 678 6670*
 BBS IBM PC Rockville, MD (301) 949 8848*
 BBS IBM PC Vienna, VA (703) 560 7803*
 BBS IBM PCmodem Chicago, IL &(312) 882 4227*
 BBS IBM PCmodem Chicago, IL (312) 376 7598*
 BULLET-80 Boston, MA &(617) 266 7789*
 BULLET-80 Chesterland, OH (216) 729 2769
 BULLET-80 Clarks Summit, PA (717) 586 2112
 BULLET-80 Danbury, CT #1(203) 744 4644
 BULLET-80 Fayetteville, GA (404) 461 9686
 BULLET-80 Hattiesburg, MS ! (601) 264 2361*
 BULLET-80 Holstein, IA (712) 368 2651
 BULLET-80 Ironton, OH (614) 532 6920
 BULLET-80 Langhorne, PA (215) 364 2180
 BULLET-80 Littlefield, TX (806) 385 6843
 BULLET-80 Marin County TRS-80 UG, CA ! (415) 897 0421-
 BULLET-80 New York, NY (212) 740 5680*
 BULLET-80 Orange County, Anaheim, CA (714) 952 2110
 BULLET-80 Seymour, CT (203) 888 7952
 BULLET-80 Springfield, IL (217) 529 1113
 BULLET-80 Tulsa, OK (918) 749 0059*
 BULLET-80 Waterford, MI (313) 683 5076*
 BULLET-80 Pirate Place, ? ! (714) 644 7942
 CBBS AMRAD, Washington, DC (703) 734 1387*
 CBBS Atlanta, GA (404) 394 4220*
 CBBS Aurora Computer Peripherals,
 Aurora (312) 897 9037*
 CBBS Baton Rouge, LA (504) 273 3116*
 CBBS Bloomington, IN (812) 334 2522
 CBBS Boston, MA (617) 646 3610*
 CBBS Cedar Rapids, IA (319) 364 0811*

CBBS Chicago, IL #1(312) 545 8086*
 CBBS CPEUG/ICST Gaithersburg, MD (301) 948 5717
 CBBS Lambda, Berkeley, CA (415) 658 2919 so.
 CBBS Lawrence General Hospital,
 Boston, MA (617) 683 2119
 CBBS LICA LIMBS, Long Island, NY (516) 561 6590*
 CBBS London, England
 (European standard) (044) 1 399 2136
 CBBS Long Island, NY (516) 334 3134*
 CBBS MAUDE Milwaukee, WI (414) 241 8364*
 CBBS MicroStar, Worcester, MA (617) 752 7284
 CBBS NW, Portland, OR (503) 646 5510*
 CBBS PACC, Pittsburgh, PA (412) 822 7176*
 CBBS Prince George, B.C., Canada (604) 562 9515
 CBBS Proxima, Berkeley, CA (415) 357 1130
 CBBS RAMS, Rochester, NY (716) 244 9531
 CBBS Rosemont, MN (612) 423 5016
 CBBS St. Petersburg, FL ! (813) 866 9945*
 CBBS Strictly Software, Honolulu, HI (808) 944 0562
 CBBS TC80, Chicago, IL (312) 949 6189
 CBBS TSG, Tucson, AZ (602) 746 3956*
 CBBS Ward and Randy's, Chicago, IL (312) 259 8086
 COMNET-80 Akron, OH &(216) 645 0827*
 COMNET-80 Laguna Hills, CA (714) 770 5052
 COMNET-80 Las Vegas, NV &(702) 870 9986
 COMNET-80 Mt. Clemens, MI &(313) 465 9531
 COMNET-80 North Wales, PA (215) 855 3809
 COMNET-80 Riverside, CA &(714) 359 3189
 COMNET-80 Riverside, CA &(714) 877 2253
 COMNET-80 Wichita Falls, TX (817) 767 5847
 CONNECTION-80 Centereach, NY (516) 588 5836
 CONNECTION-80 Denver, CO (303) 690 4566*
 CONNECTION-80 Fremont, CA (415) 651 4147*
 CONNECTION-80 Gaithersburg, MD (301) 840 8588*
 CONNECTION-80 Great Neck, NY (516) 482 8491*
 CONNECTION-80 Lansing, MI (517) 339 3367
 CONNECTION-80 Laval BELE,
 Laval, Quebec, CN (514) 622 1274*
 CONNECTION-80 Little Rock, AS (501) 372 0576
 CONNECTION-80 Manhattan, NY (212) 991 1664
 CONNECTION-80 Orlando, FL (305) 644 8327*
 CONNECTION-80 PAUG, Portland, OR (503) 281 7653
 CONNECTION-80 Peterborough, NH (603) 924 7920
 CONNECTION-80 Tulsa, OK (918) 747 1310*
 CONNECTION-80 W. Mich.
 Micro Group, MI (616) 457 1840*
 CONNECTION-80 Winter Garden, FL (305) 894 1886*
 CONNECTION-80 Woodhaven, NY (212) 441 3755*
 CONNECTION-80 Tampa, FL (813) 977 0989
 CONFERENCE-TREE Anchorage, AK (907) 344 5251
 CONFERENCE-TREE Atlanta, GA ! (404) 982 9627*
 CONFERENCE-TREE Berkeley, CA ! (408) 475 7101
 CONFERENCE-TREE Computerland,
 Honolulu, HI (808) 487 2001*
 CONFERENCE-TREE Flagship,
 Rockaway, NJ (201) 627 5151*
 CONFERENCE-TREE Honolulu, HI ! (808) 487 2001*
 CONFERENCE-TREE Hayward, CA (415) 538 3580
 CONFERENCE-TREE Kelp Bed,
 L.A., CA (213) 372 4800
 CONFERENCE-TREE Minneapolis, MN (612) 854 9691
 CONFERENCE-TREE Phoenix, AZ (602) 931 1829*
 CONFERENCE-TREE Rockaway, NJ (201) 627 5151*
 CONFERENCE-TREE
 San Francisco, CA #1(415) 861 6489
 CONFERENCE-TREE San Francisco, CA ! (415) 626 9427
 CONFERENCE-TREE Santa Monica, CA (310) 394 1505
 CONFERENCE-TREE Sausalito, CA (415) 332 8115
 CONFERENCE-TREE Victoria, TX (512) 578 5833
 DIAL-YOUR-MATCH #1 (213) 842 3322 so.
 DIAL-YOUR-MATCH #3 (912) 233 0863 so.
 DIAL-YOUR-MATCH #4 (213) 783 2305 so.
 DIAL-YOUR-MATCH #8,
 San Francisco, CA ! (415) 467 2588 so.

Bulletin Boards

DIAL-YOUR-MATCH #9	(213) 345 1047so.	NET-WORKS Charleston, WV	(304) 345 8280	PMS - Campbell, CA	(408) 370 0873*
DIAL-YOUR-MATCH #11, Carlsbad, CA	(619) 434 4600*so.	NET-WORKS Chicago, IL	(312) 882 8237	PMS - Century 23, Las Vegas, NV	(702) 878 9106*
DIAL-YOUR-MATCH #12, Houston, TX	(713) 556 1531*so.	NET-WORKS Chipmunk, Hinsdale, IL	(312) 323 3741*	PMS - Chicago, IL	(312) 373 8057*
DIAL-YOUR-MATCH #14	(201) 272 3686so.	NET-WORKS Coin Games, Los Angeles, CA	(213) 336 5535	PMS - Cincinnati, OH	(513) 671 2753
DIAL-YOUR-MATCH #16	(206) 256 6624so.	NET-WORKS College Station, Bryan, TX	(409) 846 2900*	PMS - Computer City, Danvers, MA	(617) 774 7516
DIAL-YOUR-MATCH #17	(415) 991 4911so.	NET-WORKS COMM Center		PMS - Computer Merchant, San Diego, CA	(619) 582 9557*ml.
DIAL-YOUR-MATCH #18	(617) 334 6369so.	NW3NAGAD, Laurel, MD	(301) 953 3341	PMS - Computer Solutions, Eugene, OR	(503) 689 2653*
DIAL-YOUR-MATCH #20	(919) 362 0676so.	NET-WORKS Computer City,		PMS - Datel Systems Inc., San Diego, CA	(619) 271 8613*
DIAL-YOUR-MATCH #21, Freehold, NJ	(201) 462 0435so.	Providence, RI	(401) 331 8450*	PMS - Downers Grove/SRT,	
DIAL-YOUR-MATCH #22	(213) 990 6830so.	NET-WORKS Computer Market,		Downers Grove, IL	(312) 964 6513
DIAL-YOUR-MATCH #23, Omaha, NE	(402) 571 8942so.	Honolulu, HI	(808) 524 6668-	PMS - Ed Tech, San Diego, CA	(619) 265 3428
DIAL-YOUR-MATCH #24, Houston, TX	(713) 783 4136so.	NET-WORKS Computer Pro, Ft. Worth, TX	(817) 732 1787	PMS - Ellicott City, MD	(301) 465 3176
DIAL-YOUR-MATCH #26, Clovis, CA	(209) 298 1328so.	NET-WORKS Computer Store, Honolulu, HI	(808) 488 7756	PMS - Escondido, CA	(619) 466 0667-
DIAL-YOUR-MATCH #??, NYC, NY	(212) 541 5975so.	NET-WORKS Computer World,		PMS - Floppy House, San Diego, CA	(619) 280 1958*
DIAL-YOUR-MATCH #33, Poway, CA	(619) 748 8746*so.	Los Angeles, CA	(213) 859 0894*	PMS - Ft. Smith Comp. Club, Ft. Smith, AK	(501) 646 0197
DIAL-YOUR-MATCH #37, Flint, MI	(313) 736 1398so.	NET-WORKS Crescent City,		PMS - Gameboard, San Diego, CA	(619) 283 3574*
DIAL-YOUR-MATCH #38, Austin, TX	(512) 451 8747so.	Baton Rouge, LA	(504) 454 6688	PMS - Gulfcoast, Freeport, TX	(713) 233 7943*
DIAL-YOUR-MATCH #39, Chicago, IL	(312) 243 1046so.	NET-WORKS Dallas, TX	(214) 361 1386*	PMS - Indianapolis, IN	(317) 787 5486*
FORUM-80 Augusta, GA	(803) 279 5392	NET-WORKS Dayton, OH	(513) 223 3672	PMS - Kid's Message System, San Diego, CA	(619) 578 2646*
FORUM-80 Charleston, SC	(803) 552 1612*	NET-WORKS Death Star, Oakbrook, IL	(312) 627 5138*	PMS - Lakeside, CA. (type PMS	
FORUM-80 Cleveland, OH	&(216) 486 4176	NET-WORKS Eclectic Computer Sys.,		to activate).	(619) 561 7271*
FORUM-80 #2, Denver, CO	(303) 399 8858*	Dallas, TX	(214) 239 5842	PMS - Logic Inc., Toronto, Ontario	(416) 447 8458*
FORUM-80 El Paso, TX	(915) 755 1000*	NET-WORKS Forth Dimension,		PMS - Los Angeles, CA	(213) 331 3574*
FORUM-80 Ft. Lauderdale, FL	(305) 772 4444*	St. Louis, MO	(314) 532 4652	PMS - Massillon, OH	(514) 832 8392*
FORUM-80 Hull, England	(011) 44 482 859169	NET-WORKS Granite City, IL	(618) 877 2904	PMS - Metarie, LA	(206) 889 2241*
FORUM-80 Kansas City, MO	#1 &(816) 861 7040*	NET-WORKS Greenfield, IN	(317) 326 3833*	PMS - McGraw-Hill Books, New York, NY	(212) 997 2488
FORUM-80 Kansas City, MO	&(816) 931 9316	NET-WORKS Hacker-net, Dallas, TX	(214) 824 7160	PMS - Minneapolis, MN	(612) 929 6699*
FORUM-80 Las Vegas, NV	(702) 362 3609*	NET-WORKS Hawaii	(808) 521 7312	PMS - I.A.C., Lake Forest, IL	(312) 295 6926*
FORUM-80 Linden, NJ	(201) 486 2956*	NET-WORKS Hawaii Connection,		PMS - O.A.C., Woodland Hills, CA	(213) 346 1849*
FORUM-80 Medford, OR	(503) 535 6883*	Honolulu, HI	(808) 423 1593*	PMS - Pikesville, MD	(301) 653 3413
FORUM-80 Medical, Memphis, TN	(901) 276 8196*	NET-WORKS Jolly Roger, Houston, TX	!(713) 468 0174*	PMS - Pleasanton, CA	(415) 462 7419*
FORUM-80 Monmouth, Brielle, NJ	(201) 528 6623*	NET-WORKS Livingston, NJ	(201) 994 9620*	PMS - Portland, OR	(503) 245 2536*
FORUM-80 Montgomery, AL	(205) 272 5069	NET-WORKS MAGIE, Galesburg, IL	(309) 342 7178	PMS - Portola Valley, CA	(415) 851 3453*
FORUM-80 Nashua, NH	(603) 882 5041	NET-WORKS Magnetic Fantasies, L.A., CA	(213) 388 5198	PMS - RAUG, Akron, OH	(216) 867 7463*
FORUM-80 Prince William County, VA	(703) 670 5881*	NET-WORKS MicroBBS, Chelmsford, MA	(617) 256 1446	PMS - Rutgers Univ. Microlab,	
FORUM-80 San Antonio, TX	(512) 655 8143	NET-WORKS Micro Design, Houston, TX	!(713) 864 4672-	Piscataway, NJ	(201) 932 3887
FORUM-80 San Mateo, CA	&(415) 348 2139	NET-WORKS Micro Ideas, Glenview, IL	(312) 998 5066	PMS - San Marcos, CA	(619) 727 7500*
FORUM-80 Seattle, WA	(206) 723 3282	NET-WORKS Mines of Moria, Houston, TX	!(713) 871 8577*	PMS - Santa Cruz, Aptos, CA	(408) 688 9629*
FORUM-80 Sierra Vista, AZ	(602) 458 3850*	NET-WORKS N A G S, ?, IL	!(618) 466 9497	PMS - Santee, CA	#1 (619) 561 7277*ml.
FORUM-80 Shreveport, LA	(318) 631 7107*	NET-WORKS New York, NY	(212) 410 0949	PMS - Software Unltd, Kenmore, WA	(206) 486 2368*
FORUM-80 Westford, MA	(617) 692 3973	NET-WORKS Nick Naimo,		PMS - Twin Cities, Minneapolis, MN	(612) 929 8966
FORUM-80 Wichita, KS	&(316) 682 2113*	Newburgh, IN	#1!(812) 858 5405	PMS - Your Computer Connection,	
FORUM-80 Wichita Falls, TX	(817) 855 3916	NET-WORKS North Parks, Chicago, IL	(312) 745 0924	KS City, MO	(913) 677 1299-
FORUM-80 Wild goose board, Tampa, FL	(813) 988 7400	NET-WORKS Pirate's Dream, Houston, TX	!(713) 977 5067*	PSBBS Baltimore, MD	(301) 994 0399*
Greene Machine WPB, FL	(305) 965 4388so.	NET-WORKS Pirate's Harbor, Boston, MA	(617) 720 3600	PSBBS Washington, DC	(202) 337 4694*
Greene Machine Fricaseed Chicken,		NET-WORKS Pirate's Harbor, ?, MA	!(617) 494 1985	RATS System, Whippany, NJ	#1 (201) 887 8874
Arcadia, CA	(213) 445 3591*	NET-WORKS Pirate's Lodge ???	(914) 634 1268	RATS Homewood, IL	(312) 957 3924
Greene Machine Golden State BBS,		NET-WORKS Pirate's Palace, Houston, TX	!(713) 974 5258*	RATS Wenonah, NJ	(609) 468 5293
Novato, CA	(415) 897 2783	NET-WORKS Pirate's Ship, Chicago, IL	(312) 935 2933*	RATS Wenonah, NJ #2	(609) 468 3844
Greene Machine Riverside, CA	(714) 354 8004	NET-WORKS Pirate's Trek	(516) 627 9048	RCP/M A.B. Dick Co., Niles, IL	&(312) 647 7636*
Greene Machine Chicago, IL	(312) 622 4442so.	NET-WORKS Portsmouth, NH	(603) 436 3461	RCP/M Anchorage, AK	!(907) 337 1984-
Greene Machine Corsair, WPB, FL	(305) 968 8653	NET-WORKS RJNET, Warnville, IL	(312) 393 4755	RCP/M Arlington, VA	(703) 536 3769-
Greene Machine Los Alamitos, CA	(213) 431 1443	NET-WORKS Softworx, West L.A., CA	(213) 473 2754	RCP/M Barstow, CA	\$(619) 256 3914*
Greene Machine Rome, NY	(315) 337 7720	NET-WORKS The Dark Realm,		RCP/M Beaverton, OR	!(503) 641 7276*
Greene Machine Irvine, CA	(714) 551 4336	Houston, TX	!(713) 333 2309*dd	RCP/M Boulder, CO	!(303) 499 9169-
Greene Machine Temple City, CA	(213) 287 1363	NET-WORKS The Dragon's Lair NW,	!(408) 996 7464	RCP/M Bridgeport, IL	(312) 326 4392*
HBBS Denver, CO	(303) 343 8401*	NET-WORKS The Inner Realm,		RCP/M CBBS ANAHUG, Anaheim, CA	(714) 774 7860*
HBBS El Paso, TX	(915) 592 1910	Houston, TX	!(713) 354 4690*dd	RCP/M CBBS CP/M Net Simi Valley, CA	(805) 527 9321*
HBBS Health/Zenith, Grand Rapids, MI	&(616) 531 0890	NET-WORKS The Shadow World,		RCP/M CBBS Columbus, OH	(614) 272 2227
HBBS MOG-UR, Granada Hills, CA	&(213) 366 1238*	Houston, TX	!(713) 777 8608*	RCP/M CBBS Dallas, TX	(214) 931 8274
MCMS C.A.M.S. Chicago, IL	#1 &(312) 927 1020*	NET-WORKS The Silver Tongue,		RCP/M CBBS Frog Hollow,	
MCMS J.A.M.S. Lockport, IL	(815) 838 1020*	St. Joseph, MO	(816) 232 3153	Vancouver, BC, CN	(604) 937 0906*
MCMS L.A.M.S. Round Lake, IL	(312) 740 9128	NET-WORKS The System, Houston, TX	!(713) 785 7996-	RCP/M CBBS MICOM, Melbourne,	
MCMS P.C.M.S. Wheaton, IL	&(312) 462 7560*	NET-WORKS The Weekender,		VIC, Australia	161 3 762 5088*
MCMS Goliath, Minneapolis, MN	(612) 753 3082	Houston, TX	!(713) 492 8700*	RCP/M CBBS Pasadena, CA	(213) 799 1632*
MCMS Metro West Database, Chicago, IL	&(312) 260 0640*	NET-WORKS Woodland Hills, CA	(213) 346 1849*	RCP/M CBBS RLP, MacLean, VA	(703) 524 2549*
MCMS NC Software, Minneapolis, MN	(612) 533 1957*	NET-WORKS Toronto, Ontario, CN	(416) 445 6696*	RCP/M CBBS Sacramento, CA	(916) 483 8718*
MCMS WACO Hot Line,		NET-WORKS Warlock's Castle		RCP/M CBBS Technical, Detroit, MI	&!(313) 846 6127*
Schaumburg, IL	<pvt> (312) 351 4374*	St. Louis, MO	(618) 345 6638	RCP/M Chuck Forsberg, OR	(503) 621 3193
MCMX Word Exchange, Springfield, IL	(217) 753 4309*	NET-WORKS Winesap, Dallas, TX	(214) 824 7455	RCP/M Colossal Xgate, San Jose, CA	(408) 263 2588
NET-WORKS ABC, Kansas City, MO	(816) 483 2526	NET-WORKS ?, NY	(914) 725 4060	RCP/M CUG-NOTE, Denver, CO	(303) 781 4937*
NET-WORKS Adventure's Inn,		NET-WORKS Zachary*Net, Houston, TX	!(713) 933 7353*	RCP/M CUG-NODE, PA State College	(814) 238 4857*
Lake Forest, IL	(312) 295 7284*	ONLINE Computerland, Montreal,		RCP/M Detroit, MI	(313) 584 1044b
NET-WORKS AGS, Augusta, GA	!(404) 733 3461*	Quebec, CN	(514) 931 0458*	RCP/M Edmonton, Alberta CN	&!(403) 454 6093*
NET-WORKS Apple Crackers,		ONLINE Dickinsons Movie Guide,		RCP/M DBASE [], San Jose, CA	(408) 378 8733*
Columbus, OH	!(614) 475 9791*	Mission, KS	(913) 432 5544*	RCP/M EI Division, Argonne, IL	(312) 972 6979
NET-WORKS Apple Grove, Dallas, TX	(214) 644 5197	ONLINE Indianapolis, IN <ID#=#GUES,		RCP/M El Paso, TX	(915) 598 1668*
NET-WORKS Apple Juice, Drien, IL	(312) 685 9573	pswd=pass>	(317) 787 9881*	RCP/M Elanders, NJ	&(201) 584 9227*
NET-WORKS Apple Net, Chicago, IL	(312) 963 5384	ONLINE Omega, Chicago, IL	(312) 648 4867*	RCP/M Geneseo, IL	(309) 944 5455
NET-WORKS Apple Shack, Dallas, TX	(214) 644 4781*	ONLINE Saba, San Diego, CA	(619) 692 1961*	RCP/M Glen Ellyn, Chicago, IL	(312) 469 2597*
NET-WORKS Apple-Technical, Chicago, IL	(312) 935 3091	ONLINE Lakeside, CA <ID#=#GUEST,		RCP/M Granada Hills, CA	(213) 360 5053*
NET-WORKS Armadillo, Grand Forks, ND	(701) 746 4959	pswd=PASS>	(619) 561 7271*	RCP/M HAM Radio, Morton Grove, IL	(312) 967 0052
NET-WORKS Armadillo Media,		PET BBS Commodore, Largo, FL	!(813) 391 5219+	RCP/M HAPN Hamilton, Ontario, CN	(416) 335 6620*
Houston, TX	!(713) 444 7098*	PET BBS Commodore, Chicago, IL	(312) 397 0871*	RCP/M Logan Square, Chicago, IL	(312) 252 2136*
NET-WORKS Assembly Line,		PET BBS AVC Comline, Indianapolis, IN	(317) 255 5435*	RCP/M Los Angeles, CA	!(213) 296 5927*
Louisville, KY	!(502) 459 5531-	PET BBS KCUPG, Kansas City, KS	(816) 356 2382*	RCP/M MCBBS Keith Petersen,	
NET-WORKS Asylum, ?, IL	(618) 692 0742	PET BBS S.E.W.P.U.G., Racine, WI	(414) 554 9520*	Royal Oak, MI	(313) 759 6569b.
NET-WORKS Aurora, CO	(303) 343 8401*	PET BBS SE Wyoming PUG	(307) 637 6045*	RCP/M MCBBS Ken Stritzel, Flanders, NJ	(201) 584 9227*
NET-WORKS Baud-ville, Louisville, KY	!(502) 423 0695-	PET BBS PSI WordPro, Ontario, CN	#1 (416) 624 5431*	RCP/M MCBBS TCBBS Dearborn, MI	(313) 846 6127*
NET-WORKS Beach BBS, Pensacola, FL	(904) 932 8271	PET BBS TPUG, Toronto, Ontario, CN	(416) 223 2625*	RCP/M Mid-Suffolk, Long Island, NY	!(516) 751 5639-
NET-WORKS Big Apple, Miami, FL	(305) 948 8000	PMS - *JF***, Anaheim, CA	(714) 772 8868*	RCP/M Mission, KA	(913) 362 9583*
NET-WORKS Briar-Net, Houston, TX	!(713) 782 5706*	PMS - Anchorage, AK	(907) 344 8558	RCP/M Mississauga HUG,	
NET-WORKS Brooklyn, NY	(212) 410 0949	PMS - Apple Bits, Kansas City, MO	(816) 252 0232*	Toronto, Ont., CN	\$(416) 232 2644*
NET-WORKS C.A.M.S., Decatur, IL	(217) 429 4738*	PMS - Apple Guild, Weymouth, MA	(617) 767 1303*	RCP/M NEI, Chicago, IL	&!(312) 949 6189-
		PMS - Baltimore, MD	(301) 764 1995*		

Online

RCP/M North Chicago, Chicago, IL (312) 937 5639
RCP/M Olympia, WA (206) 357 7400*
RCP/M ?, OR &(503) 621 3193*
RCP/M North Side BBS, Chicago, IL (312) 251 0168
RCP/M Oxgate 001, Saratoga, CA &(408) 867 1243*
RCP/M Oxgate 007, Grafton, VA !&(804) 898 7493*
RCP/M Palatine, IL (312) 359 8080*
RCP/M Programmers Anonymous,
Gorham, ME. &(207) 839 2337*
RCP/M Providence, Providence, RI !&(401) 751 5025rb
RCP/M RBBS AIMS, Hinsdale, IL !&(312) 789 0499*
RCP/M RBBS Allentown, PA (215) 398 3937*
RCP/M RBBS AlphaNet, Lawrence, KA !&(913) 843 4259*
RCP/M RBBS Apple UG, El Paso, TX !&(915) 533 2202*
RCP/M RBBS Arvada Elect.,
Colorado Springs, CO (303) 634 1158*
RCP/M RBBS BBS Valley (213) 360 5053
RCP/M RBBS Boulder, CO (303) 499 9169
RCP/M RBBS Bethesda, MD (301) 229 3196
RCP/M RBBS BHEC, Baltimore, MD. !&(301) 661 2175*
RCP/M RBBS Bogdanovich, New Jersey !&(201) 747 7301*
RCP/M RBBS Brewster, NY (914) 279 5693-
RCP/M RBBS Cincinnati, OH !&(513) 489 0149-
RCP/M RBBS Comp. Tech. Assoc.,
El Paso, TX (915) 533 2202*
RCP/M RBBS Computerized Services,
Tampa, FL (813) 988 7400*
RCP/M RBBS Computron, Edmonton,
Alberta, Can (403) 482 6854*
RCP/M RBBS Cranford, NJ (201) 272 1874*
RCP/M RBBS DataTech 001,
San Carlos, CA #1&(415) 595 0541*
RCP/M RBBS Edmonton, Alberta, Canada &(403) 454 6093*
RCP/M RBBS El Paso, TX (915) 598 1668
RCP/M RBBS Fort Mill, SC (803) 548 0900*
RCP/M RBBS GFRN Dta Exch.
Garden Grove, CA. &(714) 534 1547*
RCP/M RBBS GFRN Dta Exch.
Palos Verde, CA. &(213) 541 2503*
RCP/M RBBS HawkEye-PC,
Cedar Rapids, IA !&(319) 363 3314
RCP/M RBBS Helena Valley, Helena, MT. !&(406) 443 2768 +
RCP/M RBBS Hollywood, CA !&(213) 653 6398*
RCP/M RBBS Houston, TX (713) 497 5433-
RCP/M RBBS Huntsville, AL (205) 895 6749rb.
RCP/M RBBS Lakewood, Denver, CO !&(303) 985 1108*
RCP/M RBBS Laurel, MD (301) 953 3753*
RCP/M RBBS Larkspur, CA (415) 461 7726*
RCP/M RBBS Manhattan, N.Y. City, NY &!&(212) 255 7240*
RCP/M RBBS Marin County, CA (415) 383 0473*
RCP/M RBBS Mike's, Milwaukee, WI (414) 647 0903
RCP/M RBBS MUG, Mission, KS &(913) 362 9583*
RCP/M RBBS NACS/UAH, Huntsville, AL !&(205) 895 6749rb.
RCP/M RBBS Napa Valley, CA. (707) 257 6502*
RCP/M RBBS Ocean, NJ &(201) 775 8705
RCP/M RBBS Pasadena, CA !&(213) 577 9947*
RCP/M RBBS Piconet #3 Datatech,
San Jose, CA. !&(408) 238 9621*
RCP/M RBBS Piconet #4 Wiz. Keep,
San Jose, CA (408) 281 7059*
RCP/M RBBS Pickerington, OH !&(614) 837 3269
RCP/M RBBS Pinecliffe, CO &!&(303) 598 3995*
RCP/M RBBS San Jose Oxgate,
San Jose, CA (408) 287 5901*
RCP/M RBBS Surrey, Vancouver, BC, CN. (604) 584 2643*
RCP/M RBBS Pontiac, MI (313) 338 8575
RCP/M RBBS Paul Bogdanovich, NJ. (201) 747 7301
RCP/M RBBS Rochester, NY !&(716) 425 1785*
RCP/M RBBS Rutgers, New Brunswick, NJ (201) 932 3879*
RCP/M RBBS San Diego, CA &(619) 273 4354*
RCP/M RBBS Software Store, L.A., CA (213) 296 5927*
RCP/M RBBS Southfield, MI (313) 559 5326*
RCP/M RBBS Tampa, FL !&(813) 831 7276
RCP/M RBBS Westland, MI (313) 729 1905rb.
RCP/M RBBS Woodstock, NY &(914) 679 8734*
RCP/M RBBS Yelm, Olympia, WA (206) 458 3086rb.
RCP/M Redstick, Baton Rouge, LA !&(504) 291 6834-
RCP/M Rich & Famous, San Francisco, Ca !&(415) 552 9968*
RCP/M Royal Oak, Detroit, MI. &!&(313) 759 6569*rb.
RCP/M San Diego, CA. &!&(619) 534 1547*
RCP/M Satsuma, Houston, TX !&(713) 469 8893*
RCP/M Silicon Valley, CA. (408) 246 5014*
RCP/M Simi Valley, CA. !&(805) 527 2219-
RCP/M SJBSBS Bearsville, NY. (914) 679 6559*rb
RCP/M SJBSBS Johnson City, NY (607) 797 6416-
RCP/M Software Tools,
Sydney, Australia !&1 02 997 1018*
RCP/M Sunnyvale, CA !&(408) 730 8733-
RCP/M Superbrain, Lexington, MA &(617) 862 0781*
RCP/M System One, Toronto, CN. &(416) 231 9538*
RCP/M System Two, Toronto, CN &(416) 231 1262*
RCP/M Technical, Thousand Oaks, CA &!&(805) 492 5472*
RCP/M Terry O'Brien, Vancouver,
BC, Canada (604) 584 2543
RCP/M The C-Line, NJ !&(201) 625 1797-
RCP/M TRS-80 NEI, Mundelein, IL (312) 949 6189*
RCP/M W. Carrollton, Dayton, OH !&(513) 435 5201*

RCP/M Westchase, Houston, TX !&(713) 789 3355*
Remote Northstar Atlanta, GA #1(404) 926 4318*
Remote Northstar Denver, CO (303) 444 7231
Remote Northstar Largo, FL (813) 381 2394*
Remote Northstar NASA, Greenbelt, MD (301) 344 9156
Remote Northstar Santa Barbara, CA (805) 682 7876
Remote Northstar Santa Barbara, CA (805) 964 4115
Remote Northstar Virginia Beach, VA (804) 340 5246
ST80-CC Lance Micklus, Inc.
Burlington, VT #1(802) 862 7023*
ST80-PBB Monroe Camera Shop,
Monroe, NY (914) 782 7605
TCBBS Astrocom, New York, NY (212) 799 4649*
TCBBS B.A.M.S. New York, NY (212) 362 1040*
TCBBS Leigh's Computer World, NY (212) 879 6257
TCBBS AstroCom, New York, NY #1(212) 799 4649*
T-NET Central Processing Unit (313) 453 5146*
T-NET CPAC (313) 453 5146*
T-NET CVBS, Chula Vista, CA !&(619) 691 8367*
T-NET Delta Connection !&(609) 896 2436*
T-NET Special Corp (313) 855 6321*
T-NET Twilight Phone, Warren, MI #1(313) 775 1649*
TBBS Austin, TX #1(512) 447 2818*
TBBS Beer City, Milwaukee, WI. &(414) 355 8839*
TBBS Canopus, Milwaukee, WI. (414) 281 0545*
TBBS Exidy 2000, Houston, TX &(713) 442 7644*
TBBS Freelancin' Alvin, Houston, TX &(713) 331 2599*
TBBS Freelancin', Houston, TX &(713) 488 2003*
TBBS Hawkins, TX (312) 474 769 3036*
TBBS Shreveport, LA (318) 680 9613so.
TRADE-80 Albany, GA (912) 439 7440*
TRADE-80 Ft. Lauderdale, FL #1(305) 525 1192
TRADE-80 Omaha, NE. (402) 292 6184
TRADE-80 Erie, PA (814) 898 2952*

MISCELLANEOUS OR UNKNOWN SYSTEM TYPES

Access-80, Tampa, FL !&(813) 884 1506*
A.U.R.A. Atari 800, St. Louis, MO (314) 535 3799*
(?) Queens, NY (212) 896 0519
? (Western Massachusetts). (413) 637 3515
Adventure BBS (516) 621 9296
Adventurer's Tavern !&(714) 583 3103
All Night BBS. (213) 564 7636
Alpha, Tampa, FL. <acct# = ABCD00,
pwd = TRYIT> (813) 251 4092*
Aphrodite-E. (201) 790 5910so.
Apollo's Chariot, Apollo, FL (813) 645 3669
Apple-Gram (313) 295 0783*
Applecrackers, Columbus, OH. (614) 475 9791*
Apple Crunch, Houston, TX (713) 468 3122
Apple Trek IV, Houston, TX (713) 932 1124*
ARBB Seattle, WA. (206) 546 6239
Atari BBS, Virginia Beach, VA !&(804) 491 1437*
Austin Party Board, Austin, TX (512) 442 1116*
Aviators Bulletin Board, Sacramento, CA (916) 393 4459
Baton Rouge Data System, Baton Rouge, LA (504) 926 0181
Blax-80 BBS, Phoenix, AZ (602) 952 1382*
BBS Annandale, VA (703) 978 9754
BBS Apollo, Phoenix, AZ (602) 246 1432*
BBS B.R., Los Angeles, CA (213) 394 5950*
BBS Commodore, San Juan, Puerto, Rico. !&(809) 781 0350-
BBS Computer Applications Co., Poland, OH (216) 757 3711
BBS Homestead, FL (305) 246 1111
BBS MCUA, Houston, TX !&(713) 661 5428*
BBS Pensacola, FL. (904) 477 8783
BBS SUE Milwaukee, WI (414) 483 4578
BBS The BULL, Toronto, Ontario, CN (416) 423 3265so
BBS-80 DALTRUG, Dallas, TX (214) 235 8784*
Big Top Games System, Milwaukee, WI. (414) 259 9475
Bird House, San Jose, CA !&(408) 267 7399
Boston Information Exchange, Boston, MA &!&(617) 423 6985*
Bronx BBS, NY (212) 933 9459
Bradley Computer BBS (813) 734 7103
BSBB Tampa, FL (813) 885 6187
Call-A-Lawyer, Phoenix, AZ (602) 275 6644*
Capital City BBS, Albany, NY. (518) 346 3596*
Carrier 2, Alexandria, VA (703) 823 5210
Cass-80 Hickory Hills (312) 598 4861
C.M.M.S. Chicago, IL (312) 957 3924*
C-HUG Bulletin Board, Fairfax, VA (703) 360 3812*
Cohoes Forum, Cohoes, NY !&(518) 235 9073
COMM-80 Queens, NY (212) 897 3392*
Commodore Communication, St. Louis, MO !&(314) 625 4576*
Commodore Video King, ?, IL !&(312) 674 6502
Communitee - Golden Hind, St. Louis, MO !&(314) 638 0644*
Compuke-80, Houston, TX &(713) 444 7041*
Compusystems, Columbia, SC. (803) 771 0922
Computer Connection (213) 657 1799
Computers for Christ, Ontario, CA (714) 983 9923*
CVBBS, San Diego, CA (619) 691 8367*
Datamate, Canoga Park, CA #1(213) 998 7992so.
Davy Jones Locker (313) 764 1837
Diamond III, Phoenix, AZ (602) 890 0972*
Dimension-80 Orange, CA (714) 974 9788
Distra-Soft, Montreal, Quebec, CN (514) 327 5764*
Download-80 Mojo's, Forest Knolls, CA. &!&(415) 488 9145*dl
Download-80 Plus, Danville, CA #1&(415) 838 2383*dl

Dragon's Game System. (pass=DRAGON). (213) 428 5206
Drummer (415) 552 7671so.
Electric Line Connection, Sherman Oaks, CA (213) 789 9512
EMC-80 St. Louis, MO !&(314) 645 1047
Experimental-80 Kansas City, MO (913) 676 3613
FBBS #1, Purdue, IN &!&(317) 494 6643*
Future Tech, Alexandria, VA (703) 360 5439*
GBBS Metro Detroit, MI (313) 455 4227so
Genesis, Phoenix, AZ (602) 967 4529*
Great Apple, Houston, TX !&(713) 455 9502*
GroundStar System, Long Beach, CA (213) 591 7239*
Hermes-80 Allentown, PA (215) 434 3998
HEX Silver Spring, MD &(301) 593 7033*
IDBN Info-Net, Costa Mesa, CA (714) 545 7359
INFOEX-80 West Palm Beach, FL (305) 683 6044*
INFOEX-80 Akron, OH (216) 724 2125*
Interface BBS (Atari), Chicago, IL (312) 296 3883
Irvine Line, Irvine, CA (714) 551 4336
JCTS Redmond, WA (206) 883 0403*
Jolly Roger #2, Houston, TX (713) 932 1124
Kluge Computer &(213) 947 8128*
L.A. Interchange, Los Angeles, CA (213) 631 3186*
Lehigh Press BB, PA. #1(215) 435 3388
Lethbridge Gaming system, Lethbridge, AB. (403) 320 6929
LITHO/NET (800) 831 6964
Long Beach Community Computer (213) 591 7239*
Mages Inn, Omaha, NE. (402) 734 4748*
Mail Board-82 Seattle, WA (206) 527 0897*
Metron, Phoenix, AZ (602) 942 6569*
Micro-Com, Louisville, OH (216) 875 4582*
Micro-80 West Palm Beach, FL (305) 686 3695
Micro Informer, Tampa, FL (813) 875 3331
Microsystems, Phoenix, AZ (602) 938 4508*
Midwest, St. Louis, MO (314) 227 4312so.
Mini-Bin Seattle, WA (206) 762 5141*
MSG-80 Everett, WA (206) 334 7394
NBBS Norfolk, VA (804) 444 3392
North Orange County Computer Club. (714) 633 5240
Novation CO., Los Angeles, CA
<pass=CAT> (213) 881 6880
Nibble One, Schenectady, NY !&(518) 370 8343
NWWCUG Edmunds, Seattle, WA !&(206) 543 6021
Nybbles-80 Elmsford, NY (914) 592 5385
Nybbles-80 NY (212) 626 0375
OACPM Omaha, NE (402) 292 9598*
OARCS Portland, Oregon (503) 641 2798
OCTUG Orange County, Garden Grove, CA (714) 530 8226
Ohio Valley BBS (614) 423 4095*
Omega, Phoenix, AZ (602) 952 2018*
Oracle North Hollywood, CA (213) 980 5643so.
Orange County Dta Exchange,
Garden Grove, CA (714) 537 7913
OS-9 6809 BBS, Palatine (312) 397 8308
OSUNY Scarsdale, NY (914) 725 4060
PBBS Co-operative Comp Svc. Palatine, IL . (312) 359 9450*
Personal Msg. System-80,
Deerfield Bch, FL &(305) 427 6300*
PHOTO-80, Haledon, NJ (201) 790 6795
PMBBS (713) 441 4032
Potomac Micro Magic Inc.,
Falls Church, VA (703) 379 0303*
RACS V Fullerton, CA (714) 524 1228
RBBS Milwaukee-Chicago Line (312) 876 0974
Remote Apple Jackson, MS (601) 992 1918*
RS-CPM Clarksville, MI (616) 693 2648
SATUG BBS, San Antonio, TX (512) 494 0285*
Seacom-80 Seattle, WA. (206) 763 8879
SIGNON Reno, NV <pswd=FREE> (702) 826 7234
\$(702) 826 7277
SISTER Staten Island, NY (212) 442 3874*
SOBBS Poor Man's BBS, Houston, TX !&(713) 453 7931*
SOBBS Test Mode, Houston, TX !&(713) 522 5156
Software Referral Service (603) 625 1919
Stellar III, Phoenix, AZ (602) 833 0740*
Steve's BBS(also: Game Palace). (913) 648 5301*
Sunrise Omega-80, Oakland, CA (415) 452 0350
Switchboard, Alexandria, VA (703) 765 2161*
System/80 San Leandro, CA (415) 895 0699
Talk-80 ROBB, Portsmouth, VA (804) 484 9636
TCUG BBS, Washington, DC (703) 836 0384*
Tech-Link, Forest Glen, MD (301) 565 9051*
TECOM-80, Tampa, FL (813) 839 6746
Telcom 7 New Fairfield, CT (203) 746 5763*
Telemessage-80, Atlanta, GA (404) 962 0616
The Interface, Los Angeles, CA !&(213) 477 4605
Toledo Apple Users BBS, Toledo, OH (419) 867 9777*
Treasure Island (313) 547 7903
Vanmil, Milwaukee, WI (414) 271 7580*
VERGA 80, ? !&(714) 547 6220
Voyager, Phoenix, AZ (602) 247 6034
Vic-20 Online, Houston, TX !&(713) 944 6597*
Visiboard, Wellesley, MA (617) 235 5082
WAPABBS, Charlotte, NC !&(704) 373 7966*
Westside Download, Detroit, MI (313) 533 0254
XBBS Hamilton, OH (513) 863 7681*
XIO, Houston, TX (713) 495 1422*

General Tip Section

A COLLECTION OF PRACTICAL HELPS, IDEAS, AND SUGGESTIONS

WE HAVE COLLECTED A NUMBER OF VALUABLE PIECES OF INFO FOR THE ADAM-USER & HAVE ORGANIZED THEM HERE. IF YOU ARE A NEW ADAM USER, THIS SECTION IS ESPECIALLY FOR YOU...& EVEN IF YOU'RE AN OLD PRO, YOU MAY PICK UP A FEW TID-BITS HERE & THERE THAT WILL ENHANCE YOUR USE OF ADAM.

HERE'S WHAT YOU'LL FIND IN THE PAGES AHEAD:



1. **THE ADAM KIT** - THIS IS AN ARTICLE WHICH EXPLAINS HOW YOU CAN CUSTOM BUILD YOUR OWN ADAM FOR A SMALL COST. YOU MIGHT CONSIDER THIS IF YOUR BUDGET IS TIGHT, OR IF YOU WANT A SECOND ADAM AROUND.

2. **NEW ADAM BEGINNERS WORKSHOP**- (COURTESY OF NIAD) GIVES YOU THE BASICS OF GETTING STARTED WITH YOUR ADAM.

3. **BEGINNER'S BASIC WORKSHOP** - (COURTESY OF NIAD) GETS YOU GOING ON PROGRAMMING IN BASIC.

4. **DID YOU KNOW** - THIS SECTION IS JUST A COLLECTION OF MISC. "TID-BITS" OF INFO THAT CAN SAVE YOU TIME, AGGRAVATION, AND MONEY AS AN ADAM OWNER.

5. **MORE PROGRAMMING HELPS** - INFO YOU WON'T FIND IN THE MANUAL TO HELP YOU IN YOUR BASIC PROGRAMMING.

NOTICE TO HACKERS: IF YOU CONSIDER YOURSELF TOO ADVANCED FOR THIS SECTION, THE NEXT SECTION IS FOR YOU!!!!

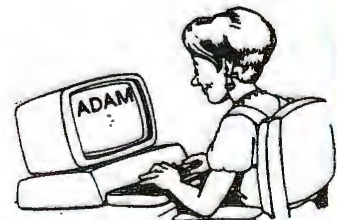
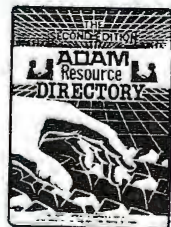
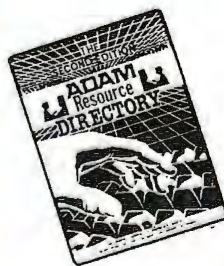

THE ADAM KIT

HOW TO BUILD YOUR OWN ADAM FROM COMPONENTS

by Gary Woodruff

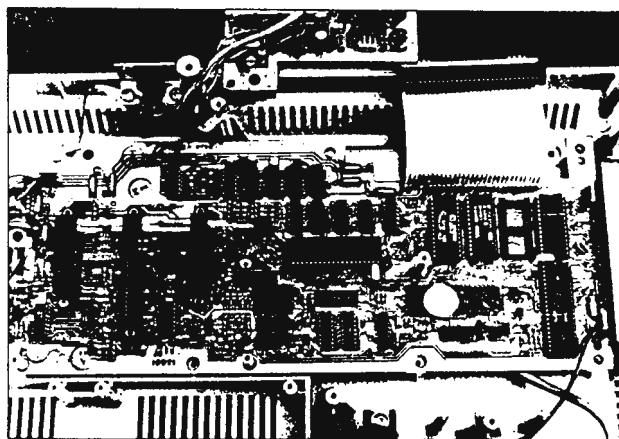

The advertisement said Coleco Adam Computer, complete, less printer and cabinet. Build your own Adam computer from components, for \$99.95.

It sounded good, and I am mechanically inclined, so I ordered one. Eight weeks later I received the following; One power supply, One each of the two component boards, One keyboard, Two data drives, Two game controllers, and One Buck Rogers game tape.

As the ad had claimed, it was all there, and could easily be plugged together to form a working computer. No soldering was required, and all the receptacles, toggle switches, etc. were present. However it would have to be put in something to protect and contain it. Checking the local Radio Shack, and other Electronics stores I found no container large enough for the job. I resorted to using whatever was at hand. I used a flat oak board as a base, and glued small wood blocks to this to provide the two tiered base for the component boards. I also glued small blocks to attach the toggle switches, and other ports. I screwed the boards in place with wood screws, with foam pads between the boards and the wood blocks. I then made the sides and top out of plexiglass. Several vent and access holes had to be made through the plexiglass, and this is not an easy job. I left one corner open to install one data drive. I only used one to keep the container as small as possible.

I now have a working Adam computer that is about two thirds as large as the original, and can look right inside to see the components. By using my Eve interface I can use any dot matrix printer to complete the package. It is not fancy, though yours could be, but it is rugged and it works.

A few things need to be explained. The first time I hooked up the power supply the electronic typewriter screen appeared and nothing would work. I traced this down to the fact that the power supply is actually the bottom portion of the printer. There usually though not always are additional electronic components from the printer on this board. Since the rest of the printer is not connected it won't function properly. I have seen in some publications a kit with a switch and wiring diagrams to get around this problem. There is a much simpler way to do this. Just disconnect the white plastic, four prong, slide connector connecting the transformer board to the other components. Also make sure that any peripheral units such as disc drives or printers are turned on before the power supply. This minor inconvenience allows for normal use of the power supply. The container I used is not shielded and this can cause serious interference with a regular TV. No interference is noticed on a monitor, just on a TV. Also when I Tried to use a roller controller with this unit my remote control TV located at the other end of the house went crazy. It turned on then off then on again, channels changed etc. Proper shielding would eliminate this. The wiring diagram provided with the kit did not describe what to do with the braided ground wire hanging from the edge of one board. I connected it to a similar position on the other board assuming this would ground the whole rig.

All in all I am real pleased with the results of this package. It is a working Adam in a smaller package. I am going to assemble another without installing a data drive to use just with my disc drives allowing for a very small container. By the way this article was written on my home built Adam home computer.

TIPS

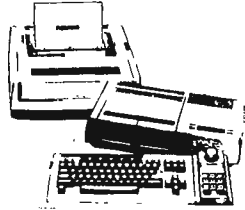

NEW ADAM OWNERS WORKSHOP COURTESY OF NIAD USER GROUP

The purpose of this column is to help new ADAM owners get started and effectively use their system.

Obviously, some of you new ADAM owners may be computer experts in that you may have had other systems and only need acclimation to the specifics of the ADAM. The rest of you may have purchased the ADAM as their first computer system.

The first thing to stress is READ the instructions and manuals supplied with your ADAM. Many questions I have answered could have been solved through reading the Coloco manuals. Now, I know that this is tough for the impetuous among us (I am one of these types), but it necessary if you want to effectively use your system. I do recommend a training course that will help you get started with your ADAM called the Learning Express. This audio course was reviewed in NIAD issue # 10 and is a great way to get started, especially if you are a new computer owner. The audio tape and manual does a nice job of stepping the novice through setting up the computer, and using both SMARTWriter and SMARTBasic. Depending on what you plan to use your ADAM for will determine what education you need. If you just plan to use the wordprocessing program (SMARTWriter) then a combination of the book supplied with ADAM and one called

The Second Book of ADAM: Using SMARTWriter.

For you potential Basic programmers, you need to plan on spending some time to learn the Basic programming language. There are alot of Basic programming books around and two that are good for the beginner are: The Coloco ADAM User's Handbook and The First Book of ADAM.

Another good book on ADAM SMARTBasic is The Basic ADAM: A Self Teaching Guide. This book is good for both the beginner, due to its approach to explanations and many examples and for the person who wants advanced programming techniques in areas such as graphics. Now if you want to get into other languages such as LOGO or use programs such as ADAMCalc or SMARTfiler you will have to study the manuals that come with these programs. I would suggest you get the back issues of NIAD to read the reviews and workshops on some of these programs.

CPM is a whole other world and I would suggest you get acquainted with the ADAM for awhile before you tackle CPM. See the CPM WORKSHOPS in the various issues for information on this operating system and associated programs.

These are some basics you need to get started.

1. The first is a "backup copy" utility that will allow you to create a second copy of important programs such as your SMARTBasic tape and other key programs. This is a commandment to insure that you have an extra copy of these key programs in case your original is lost or damaged. If you do not have one of these programs (there are a bunch on the market) you should order the NIAD Public Domain Volume UTILITY # UNDV1 which contains a program called UTILICOPY which will make back up copies of all your data packs and disks except for the SUPERgames. This is the only tape/disk backup program in the Public Domain that we are aware of. Hardware repair for your ADAM (except for the Disk Drive) can be obtained at a Honeywell Service center located near you - call information or the Coloco toll free "Hotline" for the phone number of the nearest Honeywell Service center.

3. Read reviews of software and hardware products to determine which products you are interested in. Don't buy indiscriminately just because a title sounds good because you may be disappointed and frustrated.

4. Order basic supplies of ribbons and extra data packs/diskettes so you don't run out when you're in the middle of a hot project.

BEGINNER'S BASIC WORKSHOP COURTESY OF NIAD USER GROUP

To get a catalog listing

CATALOG (optional Bn)

i.e. CATALOG catalog from last drive used --dd/disk CATALOG

D1 catalog from tape drive 1

CATALOG B3 catalog from disk drive 1

If you do not have a tape/disk in the requested drive, the system seems to lock up. Simply put a tape/disk in the drive and the catalog command is processed. Listed on the screen is the catalog listing showing the contents (files) on the tape/disk.

To get a program listing,

LIST (optional start line #,opt. end line #)

This displays, on the screen, the current program in memory (or portion of that program).

i.e. LIST lists all lines

LIST 10 lists line 10 only

LIST 10,100 lists line 10 thru 100

LIST 10, lists line 10 thru last line

LIST ,100 lists first line thru line 100

As we said, these normally go to the T.V. screen. The speed at which they are displayed is normally very fast. Long lists/catalogs scroll off the top of the screen before we can read them. Let's take a look at how we can handle these situations.

CHANGING Screen to Printer

PR#1 directs all future output to ALSO go to the ADAM printer. Output can be from list, catalog, or normal print.

PR#0 Shuts printer output off. Output only goes to screen. These commands can be either part of a BASIC program or typed in directly. Once you PR#1, the printer is on (output goes there) until you PR#0. One other thing does it. If in the middle of printer output, you do a Control/C, this will interrupt the listing AND discontinue output to printer (as if you did PR#0). To restart, redo PR#1. It is normal to have the print carriage go back to the left when you do PR#1. EXAMPLE

PR#1 : set on printer output

CATALOG: catalog list from current drive

output to screen AND printer

PR#0 : shut off printer output

If you already have text output on the screen and wish to print it, hit CONTROL/P (hold control key and the P or p). This will print all text information currently on the screen. It WILL NOT print HI-res, LO-res graphics or INVERSE text information.

Suppose you simply wish to slow down the display (screen) speed at which the information is listed. The SPEED=n command will do this. Again, either make it part of a BASIC program or type it in directly. This controls screen display speed, NOT printer speed.

i.e. SPEED=255 fastest speed

SPEED=0 slowest speed

SPEED=any value 0-255

Once set, the speed stays set until you change it.

SAMPLE PROGRAM

10 HOME:PRINT " ENTER SPEED 0 - 255"

20 PRINT " or other value to end"

30 INPUT " SPEED ";S

40 IF S < 0 OR S > 255 THEN SPEED=255:END

50 SPEED=S

60 PRINT " This is a sample"

70 PRINT " of SPEED ";S

80 PRINT " try a different value to judge"

90 GOTO 10

Run it to see the relative speeds. Just type in a numerical speed value of 0 to 255. To END, enter a numeric value other than 0 - 255 (ie 256).

The last thing we want to control is stop screen scrolling. Actually, what we want to do is PAUSE the display (not interrupt it as with Control/C). To do this, we do a Control/S (hold control key and S or s) to pause the output. To continue, hit any key (or just hit return). The output (screen or printed) will restart where it left off. Try it when running the sample program.

I hope this helps some of our new computer users out or makes the reference manual information on this a little clearer.

TIPS

Try These...



To make it easier to proof and update your Smartwriter files try this adjustment to your screen. Change the screen options to moving window format. Then set the margins to 10 and 42. This keeps all the text on the same screen, and allows for moving the cursor anywhere to edit at will.

Did YOU Know...



ADAM's printer was manufactured in Northern Ireland.



ADAM's operating system was developed by InfoSoft, and is labeled I/OS

To go to whatever screen you want to practice on Miner 2049er when the game asks for the number of players you enter 6453# followed by the screen number. * corresponds to screen 10 and # equals screen 11.



That if you have a disc drive you must turn it on first for ADAM to recognize that it's on line.



That if you poke 17529,00 the cursor will disappear from the screen, and poke 17529,66 brings it back. Poking in the ASCII number of any character will work similarly.



That by pressing CONTROL + [in the typewriter mode will take you to Smartwriter.



Your ADAM disc drive was manufactured by M.P.I. (Micro Peripherals, Inc.)



When installing a second data drive to be very careful to get these connected correctly. They can be installed one pin to either side. Failure to do this may destroy one or more of your components including the CPU.



Lightning is a terribly powerful static discharge. So called surge suppressors, spike protectors, and voltage regulators are worthless against a direct or near direct strike. Even unplugging may not protect you since lightning can jump from point to point, though this is the only resort we have. Also don't forget that your discs, and data packs can be damaged by being in proximity to the static path, and should be stored away from any danger, this includes the area around all the wires and metal around your computer work station.



Sometimes placing aluminum foil under a TV being used as a monitor will reduce interference.

Wrapping unused monitor cable in loose loops with a plastic trash fastener, or around a cardboard tube left from handtowels will sometimes reduce ghosting on your TV.



You may be able to get a blank line while using Smartwriter without the extra half line it automatically inserts, by doing the following in the first space of the line to be left blank. Hit the SUPER/SUBSCRIPT key, then hit the SUBSCRIPT key, then enter a space, hit the DONE key, and then hit RETURN. This should work.



Smartbasic does not allow for recovering H type files. By poking address 20619 with 72 will allow you to recover them.



To initialize a disc from smartbasic allowing for volume naming without the bug of 255 blocks being registered poke address 25305 with 160. This will show the correct number of blocks, and allows you to name the volume.



If you have ever been working on an extremely long smartbasic program, and wasn't able to save it due to an "OUT OF MEMORY" error message, don't give up. Some of your memory has been tied up by your manipulating your program lines. Try deleting five to ten lines at the end of the program until you free enough memory for you to save the program. Now reload the program and type back the deleted lines, nine times out of ten the program will save after this procedure.

Tips

Using Coleco Software with the Eve SPI Interface...

Checking YOUR Version...

To check your version of CPU, while in the electronic typewriter mode press CONTROL + R. look at the smartkey display at the bottom of the screen and you will see an "R" followed by a number. If your number is under R79 is has bugs in it and should be taken to honeywell for an updated version.

To check the revision number of Smartbasic, then type PRINT PEEK (260) then press RETURN. A number will appear. If its 79 or above it's OK. If it's under 79 get it replaced because it's an old version. (Some programs available will not run with the old version).

To check your revision of Disk Manager (D.O.S.), press CONTROL + R just after booting. The number 15 seems to be a good version.

To check your revision of SmartFiler, press CONTROL + R just after booting. Revision 27D is the only version that seems to operate adequately, though it seems to have some problems in the search mode. N-I-A-D. has a copy service to update your version that also takes care of the half space problem when printing.

To check your revision of AdamLink II, press CONTROL + R just after booting. Revision 12 is the newest one.

Randomize Numbers...

RANDOMIZE NUMBERS: SmartBasic's RND function returns a random real number less than 1 and greater than or equal to zero. The sequence of random numbers is the same each time Smart Basic is booted, and each time you RUN and program. This arrangement is consistent with ANSI standards, but it differs from AppleSoft tm Basic which produces a new random number each time the program runs.

Here is a little program that will randomize the numbers each time you start the program. The randomization is based on the variable length of time it takes a person to press a number on the front Paddle's keypad that is requested in the first line. ADAM strobes the keypad to see if any number has been pressed. If it was not pressed, ADAM decrements counter rx. Since it is very unlikely that people will press the keypad's number keys in the same length of time, a random seed (negative number) is produced.

Here is a program that can be tacked into the first 3 lines of your program:

```
1 PRINT "Press # on the front
  keypad to continue"
2 rx= rx - 1 : IF NOT PDL(11) THEN
  2
3 junk = RND(rx)
```

If you want to use this in a little test program that shows a bunch of random numbers between 1 and 6, type in lines 1 through 3, then add:

```
10 FOR Y = 1 TO 5
20   FOR I = 1 TO 10
30     PRINT INT(RND(1)*6+1); " ";
40 NEXT : PRINT : NEXT
```

You may wish to have a truly randomized number to start your program the first time, but start from the same number each time thereafter. If so, have your program loop back to line 3.

Eve Electronics Systems has been shipping with their SPI interface a patch to allow direct printing with Smartwriter. This patch you implement yourself onto a copy of your disk manager. There after by booting this patched disc manager then pushing the EXCAPE/WP key twice you can print directly from Smartwriter. This patch can also be used to run most other software using the regular print drivers, or pri commands.

By pressing smart key V FILE OPTIONS, then IV RUN , and then VI RUN FILE you can run Smart Basic, Smart Filer, and nearly all of the Coleco software except the Super Game Packs. This is a lot simpler then running a seperate program under Smart Basic, then using pr2 commands, and makes nearly all of the Coleco software available to your new printer easily.

Beside the Super Game Packs there are a few programs that give special problems. You cannot get Smart Letters and Forms to print directly, but you can save your letter or form to disc or datapack, then print it over the interface using Smart Writer. You cannot print out the practice drills to paper off EXPERTYPE since it uses its own print drivers. The other piece, ADAMCalc will not print directly, also because it uses its own print drivers not handled by the Eve patch. You can by using the STORE VALUES instead of the STORE SHEET command from ADAMCalc put a file on your disc, or datapack that can be accessed by Smartwriter, and printed through the SPI interface and high speed printer.

This version is not the same format as from ADAMCalc. If you have a spreadsheet more then 60 characters wide it shifts the right half one line down then compresses the form to 60 characters. It will print all the information, and is readable though not as nice as the ADAMCalc version. The ADAMCalc manual discusses this option on page 35, and describes it as a way to include spreadsheet information in a smartwriter report, etc. You can by deleting first the left part, and storing, then the right half and storing, come up with a good looking, easily read two part sheet.

As with many of the other programs people are now trying to get around these print driver problems and there may even be an easier way to handle these problems in the near future

Closing Data Files...

CLOSING DATA FILES: If you have worked with Sequential or Random Access files, you may have noticed an intermittent problem when ADAM was attempting to read data and close the file. The result was either an END OF DATA ERROR, or garbage appearing in your files.

The problem is caused by a safety feature built into SmartBasic. As with AppleSoft, SmartBasic uses PRINT CHR\$(4) as a signal to ADAM to change the I/O message to the Data Drives. But CHR\$(4) also can be used to print a heart on the screen. To help ADAM distinguish which signal is being used, PRINT CHR\$(4) is only interpreted as an I/O signal when the instruction begins in the left margin of the screen, directly after the line numbers, or after a carriage return.

Your program is often written so that the statement immediately preceding the file closing places the cursor somewhere on the screen other than the left margin. (A NEXT, or a MON,C,O,L will do this.) As a result, a heart followed by a "close..." statement appears on the screen, followed by the END OF DATA error message.

This problem can be corrected by adding an HTAB 1 to the beginning of the Close File line.

```
160 HTAB 1 : PRINT d$: "close myfile"
```

The Question Marks: When ADAM reads a data file, it prints the question mark each time it looks for an input, resulting in as many question marks as you have data items. If you find this aggravating, you can erase the question mark by adding to the INPUT line:

```
140 INPUT add$(x) : PRINT CHR$(8);
```

This causes the cursor to backspace over the question mark and rub it out each time it is printed.

These modifications are written into a sequential file program on Page 2.

An example of a Sequential File with 10 items.

Writing the File out to the Disk. The fix is on line 150.

```
5 d$ = CHR$(4)
10 REM **** Read the DATA for filling.
20 FOR x = 1 TO 10
30 READ stuff$(x)
40 NEXT x
100 REM **** Write a File called Games
110 PRINT d$: "Open Games"
120 PRINT d$: "Write Games"
130 For x = 1 TO 10
140 PRINT stuff$(x)
150 NEXT x
160 HTAB 1 : PRINT d$: "Close Games"
1000 DATA Buck Rogers, Zaxxon, Donkey Kong, Tarzan,
Choplifter, Star Trek, AE, Congo Bongo, Telly Turtle,
Dragon's Lair
```

A Program to read the file. The fixes are on lines 140 and 160.

```
5 d$ = CHR$(13) + CHR$(4)
100 REM **** Read the File called Games.
110 PRINT d$: "Open Games"
120 PRINT d$: "Read Games"
130 For x = 1 TO 10
140 INPUT stuff$(x) : PRINT CHR$(8);
150 NEXT x
160 HTAB 1 : PRINT d$: "Close Games"
170 REM **** Print out your file.
180 For x = 1 to 10
190 PRINT stuff$(x)
200 NEXT x
```

If you wish to print the contents of the file on the printer, turn the printer on after line 170. Otherwise, the printer will print the messages that go out to the data drive, and all of the question marks.

Really Clean-up your Datapacks...

REALLY DELETING FILES

WHEN YOU DELETE FILES IN SMARTBASIC, IT ACTUALLY ONLY ERASES THE FILE NAME FROM THE TAPE OR DISK. TO ACTUALLY CLEAN-UP THE TAPE, RUN THE FOLLOWING PROGRAM.

```
10 D=CHR$(4)
20 ? D$;"OPEN(FILENAME)"
30 ? D$;"WRITE(FILENAME)"
40 ?
50 ? D$;"CLOSE(FILENAME)"
```

AFTER THIS PROGRAM RUNS, TYPE IN "DELETE (FILENAME)" AND HIT RETURN.

Alignment of Columns...

Zones: If you wish to have variables printed in columns on the screen or printer, the convention used in BASIC is a comma, printed just after the variable.

Try this program:

```
10 FOR X = 1 to 20
20 PRINT X,
30 NEXT X
```

On the ADAM, this prints on the screen in two zones that are 15 columns apart, with the first zone offset to the second column.

It looks like this:

```
1          2
3          4
5          6
7          8
9         10
11        12
etc.....
```

But why is that 1 not in the column? Unfortunately, the comma that tells ADAM that the numbers are to be arranged in Zones is not read until after ADAM has received the command to print 1, so it is printed out of place.

To fix the columns so that they are in line, insert this line:

```
5 PRINT TAB(2)
```

This causes ADAM to position the cursor in the second column, and when the order is given to print the loop of numbers, the cursor is in the right place to begin.

ZONES ON THE PRINTER: The printer is not programmed to provide zones. It will dutifully print each number 15 or 16 spaces apart, but this produces an unpleasant arrangement on the page (which is 80 columns instead of the 31 columns provided on the SmartBasic screen.)

Here is one way to get the printer to print your data in five even zones:

```
5 PRINT : PRINT TAB(2)
10 FOR X = 1 TO 20
20 PRINT X,
30 IF INT(X/5) = X/5 THEN PRINT : PRINT
TAB(2)
40 NEXT X
```

It is necessary to issue two print statements in line 5. The first statement takes the printer off of the line on which it placed the Basic Bracket]. That bracket throws the printer off by one space. Line 20 throws in a Carriage Return after the fifth zone.

SMARTBasic Text-Centering Chart

Brought to you by THE OMAHA ADAM USERS CLUB and Norman R. Castro, Founder

Use H TAB	Word/Text Length	To Center Word/Text
15	1	
15	22	
14	333	
14	4444	
13	55555	
13	666666	
12	7777777	
12	88888888	
11	999999999	
11	10 - - - -10	
10	11 - - - -11	
10	12 - - - -12	
9	13 - - - -13	
9	14 - - - -14	
8	15 - - - -15	
8	16 - - - -16	
7	17 - - - -17	
7	18 - - - -18	
6	19 - - - -19	
6	20 - - - -20	
5	21 - - - -21	
5	22 - - - -22	
4	23 - - - -23	
4	24 - - - -24	
3	25 - - - -25	
3	26 - - - -26	
2	27 - - - -27	
2	28 - - - -28	
1	29 - - - -29	
1	30 - - - -30	
1	31 - - - -31	

When using SmartBASIC and you have Instructions/Text on the TV screen it is distracting to see some words that are started on one line and continue on the next line. This pyramid will help you to choose the correct H Tab to center each Line/Paragraph. Do not exceed 30 Characters per line.

The maximum number of Text lines that can be on the TV screen while in SmartBASIC is 24. This includes any spaces between paragraphs. VTAB 1 is printed on the first line while VTAB 24 will print on the last line (24). Use the VTAB first followed by the HTAB #. Example: 10 VTAB 6: HTAB 2: PRINT "Modified by Norman R. Castro" This will be on the 6th line and indented one space.

Your Text Window...

SETTING THE SIZE OF THE TEXT WINDOW: If your television screen seems too small for SmartBasic (because characters disappear off the left or right edge), or if you want to have your text appear in a "Window" on one section of the screen, here is a program that will help.

The program peeks into Basic and finds four important memory addresses. It is written to list these locations on your printer:

```
10 PRINT "Put paper in the printer." : PRINT
20 PRINT "Press any key when ready." : GET q$
30 PR#1
40 seek = 16000
50 IF PEEK(seek) = 1 AND PEEK(seek + 3) = 17 AND
   PEEK(seek + 6) = 33 AND PEEK(seek + 9) = 62 AND
   PEEK(seek + 11) = 8 THEN 70
60 seek = seek + 1 : GOTO 50
70 PRINT "Lines Address is "; seek + 1
80 PRINT TAB(5) "Present Value is "; PEEK(seek + 1)
90 PRINT "Columns Address is "; seek + 2
100 PRINT TAB(5) "Present Value is "; PEEK(seek + 2)
110 PRINT "Top Line Address is "; seek + 4
120 PRINT TAB(5) "Present Value is "; PEEK(seek + 4)
130 PRINT "Left Margin Address is "; seek + 5
140 PRINT TAB(5) "Present Value is "; PEEK(seek + 5)
150 PR#0
```

Explanation: Text displayed on ADAM'S screen is actually a map of a portion of ADAM'S memory. What you see on the screen is simply copied from that section of memory. The boundaries of the memory section are set by ADAM to 31 columns by 24 rows. You change the size of this "window" by changing numbers in the 4 memory locations. **Caution:** While it is possible to put any number (0 to 255) in these locations, you can create a situation in which ADAM is not putting characters on the screen, or one in which ADAM has no place in memory to place screen information. If you do this, you will get unsatisfactory results, and likely wind up re-booting BASIC. When you RUN the program, it will display the current value stored in each location. This value is called the DEFAULT value (the number stored in that location when BASIC is booted.)

Number of lines on your screen. ADAM'S Address: _____
(Apple's PEEK 35) Default value is 23.
To change the number of lines, POKE a number (between 3 and 23) into the "Lines Address" that you obtained when you ran the program.

POKE (address), number : TEXT

After you POKE this location, it is necessary to enter the TEXT command. ADAM only looks at the margin addresses when BASIC is first booted up, and after the TEXT command, so you must enter TEXT after changing the dimensions of your window.

Number of columns. ADAM'S Address: _____
(Apple's PEEK 33) Default is 30. To make the screen one column narrower, change this to a value of 29.
The number of columns is added to the left margin. If your left margin is set at 2, a setting of 28 columns will take the cursor over to the 30th column on the screen. **CAUTION:** If you use the CONTROL-N function to insert characters on a line, and the end of the line spills past the right margin of the screen, the text that was pushed off of the screen will be ignored by ADAM.

Top Margin: ADAM'S Address: _____
(Apple's PEEK 34) Default = 0.

Left Margin: ADAM'S Address: _____
(Apple's PEEK 32) Default = 1.

Don't split your TEXT in SMARTBasic...

IT'S EASY TO WRITE TEXT IN SMARTBASIC WITHOUT TAKING A LOT OF TIME TO MAKE SURE WORDS ARE NOT SPLIT-UP. THERE IS NOTHING MORE UNPROFESSIONAL THAN SPLIT-WORDS. DO THE FOLLOWING AND YOU'LL FIND IT TO WORK QUICKLY & EASILY ONCE YOU GET USED TO DOING IT. 1. START TYPING YOUR TEXT. 2. CONTINUE TYPING ON THE NEXT LINE. 3. WATCH TO SEE WHEN YOU ARE TYPING DIRECTLY UNDERNEATH THE QUOTATION MARK OF THE PREVIOUS LINE. 4. IF THE WORD YOU ARE TYPING DOES NOT END BEFORE REACHING THE POINT DIRECTLY UNDER THE QUOTATION MARK, YOU NEED TO SKIP ENOUGH SPACES TO START PRINTING YOUR NEXT WORD IMMEDIATELY FOLLOWING THE SPACE UNDER THE " MARK.

WHEN YOU RUN THIS PROGRAM YOU WILL FIND YOUR TEXT UN-SPLIT! IF YOU WISH TO CENTER ALL YOUR TEXT, REFER TO THE CHART LATER IN THIS SECTION.

HERE'S A BRIEF EXAMPLE OF THIS METHOD. (IT WORKS BY THE WAY ON ANY COMPUTER):

```
20 PRINT "HELLO...I AM TRYING TO
   DEMONSTRATE HOW TO TYP
   E TEXT IN SMARTBASIC AND END UP
   WITH A LOT OF SPLIT WORDS!"
```

Reusing Printer Ribbons...

Brought to you by THE OMAHA ADAM USERS CLUB
and Norman R. Castro, Pounder

PRINTER RIBBONS & REUSE/REWINDING

This modified ADAM printer ribbon case will enable you to rewind other ribbons and place them back into their former ribbon cases for reuse. Or you could use this modified ribbon case immediately after rewinding by inserting the Ribbon advance knob, pivot arm & the rubber ring. **NOTE:** If this is not done correctly the ribbon will NOT advance properly and your printed sheet will be extremely light in print.

You will need the following tools:

1. A small thin blade screwdriver
2. A clean putty knife
3. A flat 1/8" punch
4. An Xacto hammer with the steel head
5. A variable speed(preferred) electric drill
6. A 3/8" Brad point wood drill bit with cutting flutes
7. A hobby type small electric drill with a 1/4" circular blade
8. Fine sandpaper

A. Remove the small rubber ring & set aside. **NOTE:** Before removing any parts read over all of the instructions to acquaint yourself so that you will be able to replace each part correctly.

B. Use the small thin blade screwdriver to pry open the top of the ribbon case. Take your time as there are 6 plastic pins that are part of the top cover that have to be coaxed open(ried apart) from the bottom. Use the putty knife to help keep this case apart while working your way around the case. Set the top of the case aside.

C. Remove the 1" pivot arm by lifting it straight up along with the Ribbon Advance Knob & set both aside.

D. Remove the empty supply spool on the right by lifting straight up. Leave the end of the ribbon attached & set aside.

E. Take the clean putty knife & insert it carefully under the take-up spool of the used ribbon & core. Move this as one unit & set aside.

F. To remove the 2-1/2" thin round plastic disk that the used ribbon was on top of, turn over the ribbon case & tap it out & set aside.

G. Use the small hobby drill(Dremel Moto-Tool type) with the 1/4" blade & remove the 3/8" plastic stud that held the fresh supply of ribbon on the right side. Cut flush to the ribbon case & run slightly to remove burrs etc. Clean the bottom of the ribbon case & wipe with a clean rag. Set aside.

H. Take the ribbon case top and use the 1/8" flat punch on the INSIDE, where the fresh ribbon was & flatten the center dimple so that the Brad point wood drill bit won't slip.

I. Drill a 3/8" hole where that dimple was using the Brad point wood bit. You'll end up with a hole on the top of the ribbon case that will now enable you to insert a 3/8" dowel (around 8" long) into the right spool core to rewind the used ribbon on.

J. Replace the 2-1/2" thin round plastic disk on the left.

K. Replace the full used ribbon with the core intact back on the round plastic disk(use the clean putty knife). Take the empty core with the ribbon attached & put it back in the bottom right of the ribbon case.

L. Do NOT replace the Ribbon Advance Knob(Ratchet) OR the 1" pivot arm(Tongue). Thread the ribbon back on the empty core by-passing the tension wire and put the ribbon case cover back on & PRESS carefully at the 6 plastic pins(Pegs) to close this tightly. This is to insure that the ribbon will rewind evenly and not be lumpy.

M. Insert the 3/8" wood dowel in carefully as far as it go and begin to rewind COUNTER Clock Wise until finished. Do not hurry your almost finished.

N. When the rewinding is finished carefully take out the re wound supply ribbon & empty core from the left & transfer this to the original ribbon case on the right side(supply spool). Don't forget to install the Ribbon Advance Knob(Ratchet) and the 1" pivot arm(Tongue) back in. Rethread the ribbon as shown & don't forget the tension wire.

DRAWING COURTESY OF
NICKELODEON GRAPHICS

NOTE: IF YOU FIND IT PRINTS DARK FOR A WHILE BUT SHOUDL BECOMES TOO LIGHT IT IS BECAUSE THE RIBBON IS NOT MOVING IN THE PROPER GUIDE PATH. THIS IS USUALLY CAUSED BY...
1. Ribbon not positioned around the R. side of the tension wire.
2. Ribbon not positioned properly around the ratchet on the left side.
Pop the top and compare how it looks to the sketch.

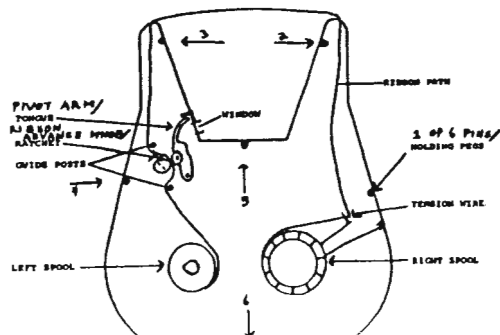

What About SmartBasic II

COLECO NEVER DID RELEASE (AT LEAST OFFICIALLY) SMARTBASIC II. HOWEVER, A GROWING NUMBER OF PEOPLE ACROSS THE COUNTRY ARE OBTAINING COPIES OF IT FROM FRIENDS, USER GROUPS, ETC.. NOBODY'S REALLY SURE WHERE IT ORIGINALLY CAME FROM, BUT IT APPARENTLY IT WAS "BRIEF-CASED" OUT OF COLECO. SINCE THERE IS A GROWING INTEREST IN THIS, WE HAVE INCLUDED A FEW FACTS WE HAVE OBTAINED ABOUT SMARTBASIC II. AS TO OBTAINING YOUR OWN COPY, YOU'LL NEED TO ASK AROUND!

WELL...HERE'S A FEW SMARTBASIC II.....

- 1) The 64K expander is accessed in a "bank-switch" configuration..To switch to the Memory Expander, then command is EXTHEM, and the command to switch back is STDMEM. This, fully realized, could be a boon.. imagine storing the data files for programs in the memory expander..then switching back and forth as needed..
- 2) SBII (abbrev.) also allows calls to the music chip and to the sprites..although exactly HOW is not known save to the designer. More on this later as it develops...
- 3) SBII has a slightly jazzes-up screen display and also has definitions for some of the dedicated function keys..PRINT is the same as Ctrl-P, INSERT the same as Ctrl-M, and DELETE the same as Ctrl-O.
- 4) SBII allows you to break a Ctrl-P with a Ctrl-C..so you can recover from a screen dump without having to reset the computer.
- 5) SBII has a larger free space for programs, EVEN THOUGH SBII is larger than SBI. (FRE(0) shows about 7K more space than SBI.)
- 6) SBII allows you to merge files together...format for this is MERGE <filename>.. It loads the designated file into memory and merges it with the current program..If any line numbers are the same, the new ones replace the old, just as if you had retyped the lines.
- 7) a minor point..SBII has a redesigned jump table and function call addresses are NOT the same.. so a program that runs in SBI that make use of the SmartBasic direct function CALLS will NOT WORK without major modification.

TIPS



Thou Shalt Not Dupe

Either Way It's Wrong

People who would never walk into a store and shoplift a software product think nothing of making several copies of the same software. The results are the same. The act is just as wrong.

When it comes to unauthorized duplication of software, many people do not realize the costly impact on the software developer and the customer community. The relationship between customer and developer in a software transaction is one of mutual trust. The customer trusts that the developer has produced a product that will deliver the desired result, performs according to specifications, and is properly documented and supported. The developer trusts that the customer will make use of only those copies for which he has purchased a license, even though making additional, unauthorized copies

violates the U.S. Copyright Law, and unfairly deprives software developers of revenue they are entitled to receive for their work.

Software developers find that thousands of illegal copies have been made by customers who either innocently believe they are doing nothing wrong or simply choose to ignore the law.

The Law is Clear

Reproducing computer software without authorization violates the U.S. Copyright Law. It is a Federal offense. The money paid for a software product represents a license fee for the use of one copy. It does not represent an authorization to copy. Civil damages for unauthorized software copying can be as much as \$50,000 or more and criminal penalties include fines and imprisonment. Bills have been introduced in Congress to strengthen the law and increase penalties.

Myths and Facts of Software

Let's start by dispelling some myths with a few facts.

First, software developers *do not* condone unauthorized copying in order to gain market penetration.

Second, the price of software *does not* make unauthorized copying justifiable. The cost of a software product to a consumer represents only a small fraction of the publisher's development and marketing costs.

Third, although the cost of *softlifting* is borne initially by the software developer, it is paid for ultimately by legitimate users.

What It Means to You

It's obvious that legitimate software users are paying for theft along with software developers.

It's obvious, too, that no one is going to put up with it for long. Think twice before you ask someone to give you an illegal copy of their software. Think three times before you offer to do it for someone else. *Softlifting* or *software piracy* is not only a crime: it's simply wrong.

Where to Get More Information

ADAPSO represents more than 750 corporate members that provide a wide spectrum of computer services and software including micro, mini and mainframe software products; professional software services; batch and remote processing services; integrated hardware/software systems; education and training; and consulting.

For further information or questions on software protection, contact ADAPSO at Suite 300, 1300 North 17th Street Arlington, VA 22209; or phone (703) 522-5055.

OUR BEST TIP...

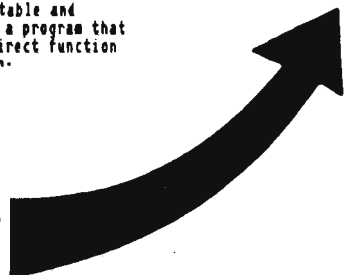

AS AN ADAM OWNER, OUR BEST TIP TO YOU, IF YOU WANT THE ADAM COMPUTER SYSTEM TO LIVE ON...AND IF YOU WANT THERE TO BE A CONTINUED PRODUCTION OF NEW ADAM SOFTWARE, DON'T DUPE SOFTWARE FOR YOUR FRIENDS. UNLESS IT'S PD SOFTWARE AND UNLESS YOU HAVE PERMISSION....IT'S AGAINST THE LAW.....AND YOU, AS AN ADAM OWNER WILL LOSE IN THE END. SUPPORT THE ADAM COMPANIES & THEY WILL CONTINUE TO SUPPORT YOU. READ THE ARTICLE TO THE RIGHT.

**The ADAM
Resource**

The Adam-Hacker Section

**Special helps to
the serious Adam User**
**IN THIS SECTION WE OFFER SEVERAL PAGES
OF REFERENCE MATERIAL FOR THE "REAL"
ADAM PROGRAMMER.**

**IF YOU ARE EXTREMELY INTERESTED IN THIS AREA, WE RECOMMEND
TO YOU *THE HACKER'S GUIDE TO ADAM VOLUMNS 1 & 2* by
*HINKLE.***

(ADDRESS IN RETAILERS SECTION.)

**IF YOUR INTO TELECOMMUNICATIONS, WE RECOMMEND *THE
HACKER'S HANDBOOK*, AVAILABLE FROM *THE ADAM RESOURCE*
FOR \$12.95 (SEE ADAM SHOPPER SECTION FOR DETAILS)**

**TAKE A CLOSER LOOK
AT WHAT MAKES
ADAM TICK!**



POKES & PEEKS



HERE IS A RELATIVELY LARGE COLLECTION OF POKES & PEEKS FOR THE MORE SERIOUS ADAM PROGRAMMER ALONG WITH A SHORT DESCRIPTION. THE ORIGINAL LIST WAS GIVEN TO *THE ADAM RESOURCE* BY THE *LAS VEGAS ADAM USERS CLUB*. WE HAVE UPDATED THIS LIST FROM VARIOUS SOURCES & PUT IT ALL TOGETHER FOR EASY REFERENCE.

HERE ARE A COUPLE OF DEFINITIONS THAT YOU NEED TO BE FAMILIAR WITH BEFORE USING THESE IN PROGRAMS:

POKE - This alters the contents of a memory location. It stores a designated value directly into a specific memory location. Refer to your manual for more info. It's dangerous to POKE around & not know what you're doing!

PEEK - This allows you to just look at the data in a particular memory location. You can PEEK into RAM.

CALL - Lets you execute a machine-language subroutine at a specified memory location.

CALL 6047	END COMMAND
CALL 6159	RUN COMMAND
CALL 6336	TRACE COMMAND
CALL 6341	NOTRACE COMMAND
CALL 6356	NEW COMMAND
CALL 6378	STOP COMMAND
CALL 6387	CONT COMMAND
CALL 8109	CLEAR ERROR (CLRERR)
CALL 8141	CLEAR COMMAND
CALL 8313	RESUME COMMAND
CALL 8477	RETURN
CALL 8493	POP COMMAND
CALL 9482	RESTORE COMMAND
CALL 11050	FLASH
CALL 11055	INVERSE
CALL 11060	NORMAL
CALL 11065	TEXT
CALL 11070	GR COMMAND
CALL 11075	HGR COMMAND
CALL 11080	HGR2 COMMAND
CALL 11090	HOME
CALL 12137	GET#
CALL 12159	INPUT
CALL 17008	TEXT
CALL 19504-19526	Prints CHARACTER
CALL 19520	HOMES CURSOR W/O SCREEN CLEAR
CALL 19526	"END PAGE" symbol
CALL 19529	STOP
CALL 19550	BREAK
CALL 63585	"WARM BOOT"
CALL 64560	TYPEWRITER
CALL 64885	LAST KEY PRESSED

PEEK 16102	HIGH BYTE OF ADDRESS WHERE THE LARGEST LINE NUMBER IS STORED IN THE LINE # TABLE
PEEK 16101	LOW BYTE OF ADDRESS WHERE THE LARGEST LINE NUMBER IS STORED IN THE LINE # TABLE
PEEK 16641,x	VALUE OF START-UP STORAGE DEVICE
PEEK 16779,x	PADDLE (6) LEFT TRIGGER [0=off, 1=on]
PEEK 16780,x	PADDLE (8) RIGHT TRIGGER [0=off, 1=on]
PEEK 16781,15	PADDLE (12) KEY PAD # PRESSED [**=10, #=11]
PEEK 16783,x	PADDLE (5) DIRECTION [1=Up,2=Rt,4=Dn,8=Lt]
PEEK 16784,x	PADDLE (7) LEFT TRIGGER [0=off, 1=on]
PEEK 16785,x	PADDLE (9) RIGHT TRIGGER [0=off, 1=on]
PEEK 16786,15	PADDLE (13) KEY PAD # PRESSED [**=10, #=11]
PEEK 16788,x	PADDLE (4) DIRECTION [1=Up,2=Rt,4=Dn,8=Lt]
PEEK 16954,x	VALUE OF CHR WHEN HOME PRESSED (<32)
PEEK 64885	LAST KEY PRESSED

POKE 159	FLASH DELAY TIME BETWEEN PULSES (12)
POKE 260	VERSION OF SMARTBASIC
POKE 1145,x	NUMBER OF PROMPT FONTS
POKE 1146,93	ASCII OF THE PROMPT CHR.
POKE 1147,x	SECOND PROMPT FONT
POKE 16089,x	HIMEM LOW BYTE
POKE 16090,x	HIMEM HIGH BYTE
POKE 16091,x	# OF PROGRAM LINES LOW BYTE
POKE 16092,x	# OF PROGRAM LINES HIGH BYTE
POKE 16095,x	LOMEM LOW BYTE
POKE 16096,x	LOMEM HIGH BYTE
POKE 16099,x	START NUMERIC VARIABLES LOW BYTE
POKE 16100,x	START NUMERIC VARIABLES HIGH BYTE
POKE 16109,x	END NUMERIC VARIABLES LOW BYTE
POKE 16110,x	END NUMERIC VARIABLES HIGH BYTE
POKE 16111,x	START STRING STORAGE LOW BYTE
POKE 16112,x	START STRING STORAGE HIGH BYTE
POKE 16115,x	END STRING STORAGE LOW BYTE
POKE 16116,x	END STRING STORAGE HIGH BYTE
POKE 16126,x	LINE # FOR ONERR GOTO LOW BYTE
POKE 16127,x	LINE # FOR ONERR GOTO HIGH BYTE
POKE 16129,x	SPEED VALUE
POKE 16136,0	GET# OR PAUSE

HIGHER

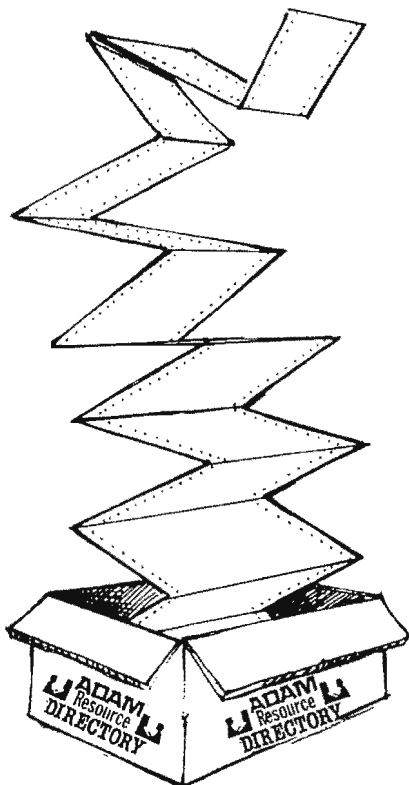

POKES & PEEKS



POKE 16149,255 \ ■ ENABLES POKES UP TO 65535
 POKE 16150,255 /
 POKE 16178,x CONTROLS OUTPUT OF THE # OF SIGNIFICANT DIGITS

POKE 16588-16645 HELLO SEARCH ROUTINE
 POKE 16651,x LAST KEYBOARD ENTRY
 POKE 16680-16687 TURNKEY FILENAME
 POKE 16763,x LAST H PLOT x,VALUE
 POKE 16764,y LAST H PLOT y,VALUE
 POKE 16763,255 HGR MODE
 POKE 16764,255 HGR2 MODE
 POKE 16765,x SCALE VALUE
 POKE 16766 NUMBER OF ROWS IN HGR MODE
 POKE 16767 NUMBER OF COLUMNS IN HGR MODE
 POKE 16768 TOP LINE HGR MODE
 POKE 16769 LEFT MARGIN HGR MODE
 POKE 16766,x COLOR VALUE
 POKE 16777,(0-15) COLOR OF H PLOT
 POKE 16796-16807 FILENAME BUFFER
 POKE 16821,4 VALUE OF DISK DR.#1
 POKE 16821,5 VALUE OF DISK DR.#2
 POKE 16821,8 VALUE OF DATA DR.#1
 POKE 16821,24 VALUE OF DATA DR.#2
 POKE 16953,32 BLANK CURSOR
 POKE 16953,95 NORMAL CURSOR
 POKE 16953,# ANY CHARACTER ASC(#) AS CURSOR
 POKE 16954,x HOME BLANK SPACES
 POKE 16956,x VALUE OF LEFT MARGIN (default =1)
 POKE 16957,x VALUE OF RIGHT MARGIN (default =31)
 POKE 16958,x VALUE OF TOP MARGIN (text=0 GR&HGR=20)
 POKE 16958,16 GIVES 4 EXTRA LINES OF TEXT IN GRAPHICS
 POKE 16959,x BOTTOM MARGIN (default=23)
 POKE 16993,x TEXT LINES TO CLEAR GR & HGR MODE (4)
 POKE 16994,x TEXT LINES TO CLEAR TEXT MODE (24)
 POKE 16995,x HOMED CURSOR LINE # PLUS CLEAR SCREEN
 POKE 16996,x HOME TO LEFT MARGIN# (default=1)
 POKE 17000,1 STAEYD CURSOR
 POKE 17000,0 BLINKING CURSOR
 POKE 17001,x VALUE OF VERTICAL POSITION OF CURSOR
 POKE 17002,x VALUE OF HORIZONTAL POSITION OF CURSOR
 POKE 17009,0 OPENS UP VIDEO PROCESSOR FOR INPUT
 POKE 17059,x FRAME COLOR (text)
 POKE 17115,x TEXT & WINDOW COLOR (text)
 POKE 17126,x INVERSE COLOR (text)
 POKE 17198,x # OF LINES (23)
 POKE 17199,x # OF COLUMNS (30)
 POKE 17201,x TOP LINE TEXT WINDOW
 POKE 17202,x LEFT MARGIN (1)
 POKE 17291,x CURSOR SPEED
 POKE 17302,17 TURN OFF CONTROL P & CONTROL O
 POKE 17950,x FIRST BYTE BELL TONE
 POKE 17954,x SECOND BYTE BELL TONE
 POKE 17956,121 CHR*(7) TONE [120=Lower, 122=Higher]
 POKE 17958,x BELL VOLUME
 POKE 17963,7 CHR*(7) SOUND DURATION (1-255)
 POKE 18607,x GR BACKGROUND
 POKE 18633,x GR GRAPHICS WINDOW
 POKE 18705,(1-5) # OF LINES IN GRAPHICS TEXT WINDOW
 POKE 18711,x GRAPHICS TEXT WINDOW COLOR
 POKE 23328,x MAXIMUM FILENAME LENGTH
 POKE 25431,x GRAPHICS WINDOW COLOR
 POKE 25471,x HGR WINDOW COLOR
 POKE 25568,x TEXT COLOR IN HGR MODE
 POKE 27100,x PADDLE #0's Vertical POSITION
 POKE 27101,x PADDLE #2's Horizontal POSITION
 POKE 27102,x PADDLE #1's Vertical POSITION
 POKE 27103,x PADDLE #3's Horizontal POSITION

MEMORY INFORMATION

256 -27406	BASIC INTERPRETER
267 -817	PRIMARY BASIC WORD TABLE
818 -936	SECONDARY BASIC WORD TABLE
937 -1055	COMMAND PARAMETER ADDRESSES
1152 -1463	BASIC COMMAND ERROR MESSAGES
6423 -6556	POINTERS TO COMMAND EXECUTION ADDRESSES
6500 -15000 approx.	BASIC COMMAND ROUTINES
15000-16050 approx.	ROUTINES TO CONSTRUCT MACHINE LANGUAGE CODE
FOR BASIC	
16089-16118	POINTERS TO FLOATING STACKS
17000-20000	VARIOUS TEXT AND GR SCREEN CONTROLS AND
CHECKS	
20138-20302	O. S. COMMANDS
20303-20389	ADDRESS TABLE
20390,24127	ACTUAL TAPE DISK ROUTINES
24128,24296	O. S. BASIC COMMAND ERROR MESSAGES
25000-27000	HGR SCREEN CONTROLS AND CHECKS
54272-65535	OPERATING SYSTEM
54272-55295 (1024 bytes)	CATALOG BUFFER AREA
55296-56319 (1024 bytes)	BUFFER FOR FIRST FILE OPENED
56320-57343 (1024 bytes)	BUFFER FOR SECOND FILE OPENED
57344-64511	ELEMENTARY OPERATING SYSTEM EOS
64512-64559	OPERATING SYSTEM DATA TABLE
64560-64860	OPERATING SYSTEM JUMP TABLE
64861-65215	OPERATING SYSTEM RAM

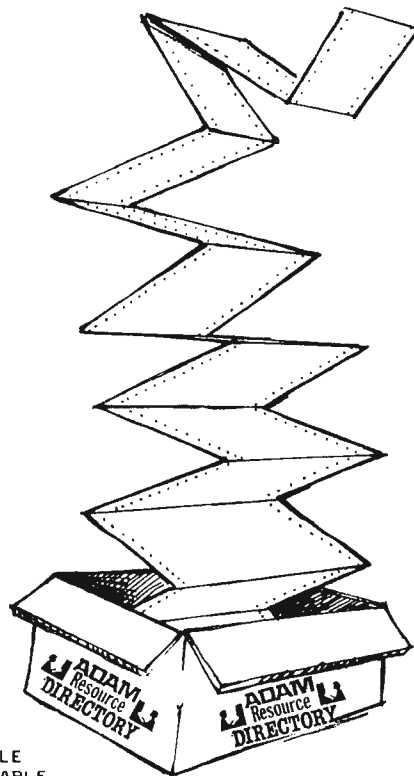

Hacker

Adam System Calls

by Darrell R. Sage

THIS WAS ORIGINALLY PRINTED IN EXPANDABLE COMPUTER NEWS ISSUES 11 THROUGH 15. THEY ARE REPRINTED HERE AS A COURTESY OF SAGE ENTERPRISES. IF YOU HAVE AN INTEREST IN THIS AREA, THIS SERIES WILL CONTINUE IN FUTURE ISSUES OF THE EXPANDABLE COMPUTER NEWS. WE HIGHLY RECOMMEND THIS PUBLICATION TO ALL ADAM OWNERS.(SEE SHOPPER SECTION FOR DETAILS ON THE SERVICES OF SAGE ENTERPRISES)

ADAM SYSTEM CALLS

by D. Sage

Over the last year I have spent a substantial amount of time disassembling the ADAM operating system. Actually the ADAM has two operating systems that have been designated EOS and OS7. The OS7 system is essentially the Colecovision cartridge system and this is used to handle most of the sound and graphics that are produced on the ADAM. The EOS is the ADAM's primary operating system that handles I/O and other system functions.

This column will be used to present the various system calls that are available to the user in SmartBasic. This column will not be a tutorial on assembly or machine language programming. I will simply present the information with a brief explanation of its function and how it is used, what you do with it is up to you. To use the calls you will have to understand the Z80 and its machine language. In most cases you will have to write machine language routines in order to provide the called routines with the information that they require. In previous issues I have already given some information on writing such routines for using some of the calls to the video display processor and the sound chip.

As I said earlier, I have spent a lot of time disassembling the Adam's operating system. After I had completed that task, Coleco provided us with a copy of their technical manual for the ADAM. Unfortunately the technical manual is not very well organized and contains what I consider to be some major gaps. The manual clearly is not designed for the novice. Even though I have the manual, I feel that much of what I learned in disassembling the OS was more than worth while. Unfortunately, the technical manual includes almost nothing on SmartBasic and its memory map. For that information you should consult the previous issues of ECN for many peeks and pokes and the Hacker's Guide to ADAM which is a great deal more organized (the Hacker's Guide is available for \$12.95 from Peter & Ben Hinkle, 117 Northview Road, Ithaca, NY 14850 or MW Ruth Co.).

In this column numbers will generally be presented in hex format and will be so designated by a following '\$' sign, for example: 4D32\$. All numbers without the dollar sign will be in regular decimal format. Each of the CALL statements will include a description of the registers used for input in the call and a description of the output registers, if any. We will publish a few CALLS each issue until we have covered the entire list of CALLS available.

First of all you should know that the operating system CALLS do not directly address any routines, but are directed to a jump table that contains another CALL instruction and the actual location of the routine. For example the CALL FC30\$ (64560) actually CALLS a routine at F832\$ (63538). This was done so that the CALL statement would remain the same for a particular routine even if the routine were changed and placed in a new location. So revisions to the operating system could be made without affecting any existing programs provided they used only CALLS to the jump table. Programs which failed to follow this practice would not run. This is probably the reason some cartridge games will not run correctly on the stand-alone ADAM (Defender is one example).

CALL FC30\$ (64560) - This routine executes a system reset and causes the operating system to check the various devices for a disk or data pack.

The order of the check is device #4, #5, #8 and #24. Device #4 is disk drive #1; #5 is disk drive #2; #8 is data drive #1 and #24 is data drive #2. If one of the drives contain media, then block #D is read to locate boot instructions if none is present or an error is encountered then the system loads the Electronic Typewriter from ROM. If a boot record is present the system loads it to C800\$ (51800) and branches to it where the boot routine takes control. In addition this routine performs a number of housekeeping functions such as clearing video RAM, turning off the sound and setting up the Device Control Blocks (DCB's).

CALL FC33\$ (64563) - Display the character whose value is stored in register A. This one is easy to check out. All you have to do is place a value in the A register (LDA x) and CALL the routine. The character will be displayed at the current cursor position and the cursor will be moved one place to the right. This routine will not execute the control characters, but will instead print them on the screen if there is a corresponding graphic character in video RAM.

CALL FC36\$ (64566) - Initialize the video display screen. HL register contains the video RAM screen address. This information appears to be stored in memory at FD64\$ (64868). Additional information needed by this call and the associated registers are as follows: B register = line length -1 (normally 31); C register = screen lines -1 (23); D register = cursor position (column); E register = cursor position (row).

CALL FC39\$ (64569) - Send a character to the screen and display it or execute the appropriate action if the code represents a control character. The code for the character is stored in the A register. Most of the control characters are described in the SmartBasic manual.

CALL FC3C\$ (64572) - This is a delay that is executed after a hard reset. It is approximately 40 micro-seconds in duration. Only the A register is killed (cleared).

CALL FC3F\$ (64575) - Checks the DCB command/status byte to determine status of printer. Reissues print command to a busy printer if no error is returned. The A register return the error code, if any. This routine is used with the start-up call.

CALL FC42\$ (64578) - Calls the same routine listed above (FC3F\$).

That completes the calls for this issue. Next issue we'll have more.

CALL FC45\$ (64581) - This routine checks on I/O progress. Checks on DCB (device control block). Determines if I/O read is complete and error free. A register contains the device ID at start and the error code, if any, is returned in the A register.

Adam System Calls Cont...

CALL FC48\$ (64584) - Similar to FC45\$ but used for the keyboard I/O. A register usage is the same.

CALL FC4B\$ (64587) - Get keyboard key or current status. If key press has occurred place key in buffer. Error code, if any, is returned in register A. This appears to be a non-waiting command.

CALL FC4E\$ (64590) - checks I/O status following a write. A register is device ID and error code, if any, is returned in A register.

CALL FC51\$ (64593) - checks I/O write status of printer. A register is device ID and error code is returned in A register.

CALL FC54\$ (64596) - Finds the Device Control Block for a specified device ID. A register is the device ID and IY contains the start of the DCB.

CALL FC57\$ (64599) - Identical to FC54\$.

CALL FC5A\$ (64602) - Get address of Processor Control Block (PCB) for current PCB. Starting address returned in IY register.

CALL FC5D\$ (64605) - This is a Hard Init. All devices are reset and all PCBs and DCBs are cleared and checks for all active devices.

CALL FC60\$ (64608) - sends OF\$ to port 3F\$, wait 2ms, send OD\$ to port 3F\$. This is essentially a hard reset of the ADAM NET.

CALL FC63\$ (64611) - send a string to the printer. The location of the string is stored in HL register and the string must be terminated by an ETX (this is simply the value 03). Any error code is returned in the A register.

CALL FC66\$ (64614) - send one character to the printer. The character is stored in A register and any error code is returned in the A register.

CALL FC69\$ (64617) - read a block from a block device. Register A is the device number, HL register contains the destination address of the data, register BCDE contains the block number to be read.

CALL FC6C\$ (64620) - read a character from the keyboard and store it in the A register. If there is an error the error code is returned in the A register.

CALL FC6F\$ (64623) - read DCB return codes (completion code) for keyboard. Code returned in A register.

CALL FC72\$ (64626) - same as FC6F\$ for printer.

CALL FC75\$ (64629) - same as FC6F\$ for device specified in A register.

CALL FC78\$ (64632) - same as FC6F\$ for tape device.

CALL FC7B\$ (64635) - relocate current PCB (Processor Control Block?). Register HL contains new address of PCB.

CALL FC7E\$ (64638) - Initiate a status request command. IY register contains the address of DCB and error code, if any, is returned in register A.

CALL FC81\$ (64641) - similar to preceding but requests status of keyboard.

CALL FC84\$ (64644) - status of printer.

CALL FC87\$ (64647) - status of data drive.

CALL FC8A\$ (64650) - scan active devices. 1 DCB allocated for each device identified by a status request.

CALL FC8D\$ (64653) - initialize the I/O processor with control area at value in register HL.

CALL FC90\$ (64656) - reset the device whose number is in register A.

CALL FC93\$ (64659) - reset the keyboard.

CALL FC96\$ (64662) - reset the printer.

CALL FC99\$ (64665) - reset data drive.

CALL FC9C\$ (64668) - start-up typing a string to the printer, but does not wait for completion. Register HL contains the string.

CALL FC9F\$ (64671) - start-up typing a character to the printer, but does not wait for completion. Character is in register A.

CALL FCA2\$ (64674) - start-up a block read for device in register A. BCDE is the physical block to read and register HL contains memory location to store data.

CALL FCA5\$ (64677) - start-up a byte read for device in A. BC contains the byte requested and DE the destination for storing the byte.

CALL FCA8\$ (64680) Start-up a keyboard byte read.

CALL FCA8\$ (64683) Start up a write for a block device. Register A = device ID (low nibble is device address, high nibble is secondary device ID). HL register contains the source address in RAM of the data to transfer. BC and DE registers contain the sector number on the device. The error code if any is returned in the A register.

CALL FCAE\$ (64686) Start up a write for a byte (character) device. Register A = device ID, BC = number of bytes to write, HL = source of data, return error code in A.

CALL FCB1\$ (64689) Init bump. Start of a larger I/O routine. Carries out synchronization.

CALL FCB4\$ (64692) writes one block to a block driver. Register A = device id, HL = source address in RAM, BCDE = sector number on device, return error code in A.

CALL FCB7\$ (64695) Write byte (character) device. Register A = device ID, BC = number of bytes, HL = source of data, return error in A.

CALL FCB8\$ (64698) File Manager Init. Register DE = address of FCB buffers, HL address to place FCB headers.

CALL FCBD\$ (64701) Initialize tape directory. Register A = device ID, C = number of sectors in directory, DE = number of sectors in Device, HL = pointer to ASCII ETX terminated string (volume ID of 12 characters), return error in A.

CALL FCC0\$ (64704) Open file. Register A = device ID, HL = address of file name string, B = mode (sub-type), error returned in A.

CALL FCC3\$ (64707) Close a file. Register A = file number (1 or 2), return error in A.

Standard ASCII Code Table

NORMAL	INVERSE	NORMAL	INVERSE	NORMAL	INVERSE	NORMAL	INVERSE
A = 65	193	a = 97	225	0 = 48	176	<CR> = 32	160
B = 66	194	b = 98	226	1 = 49	177	! = 33	161
C = 67	195	c = 99	227	2 = 50	178	" = 34	162
D = 68	196	d = 100	228	3 = 51	179	# = 35	163
E = 69	197	e = 101	229	4 = 52	180	\$ = 36	164
F = 70	198	f = 102	230	5 = 53	181	% = 37	165
G = 71	199	g = 103	231	6 = 54	182	& = 38	166
H = 72	200	h = 104	232	7 = 55	183	' = 39	167
I = 73	201	i = 105	233	8 = 56	184	(= 40	168
J = 74	202	j = 106	234	9 = 57	185) = 41	169
K = 75	203	k = 107	235			* = 42	170
L = 76	204	l = 108	236			+ = 43	171
M = 77	205	m = 109	237			, = 44	172
N = 78	206	n = 110	238			- = 45	173
O = 79	207	o = 111	239			. = 46	174
P = 80	208	p = 112	240			/ = 47	175
Q = 81	209	q = 113	241			: = 58	186
R = 82	210	r = 114	242			; = 59	187
S = 83	211	s = 115	243			< = 60	188
T = 84	212	t = 116	244			= = 61	189
U = 85	213	u = 117	245			> = 62	190
V = 86	214	v = 118	246			? = 63	191
W = 87	215	w = 119	247			@ = 64	192
X = 88	216	x = 120	248			[= 91	219
Y = 89	217	y = 121	249			\ = 92	220
Z = 90	218	z = 122	250] = 93	221
						^ = 94	222
						_ = 95	223
						~ = 96	224
						{ = 123	251
						= 124	252
						} = 125	253
						~ = 126	254

Apple/Adam Equivalents

Courtesy of N.L.A.D. User Group

THE NIAD USER GROUP HAS PROVIDED US WITH THIS USEFUL INFO FOR ALL YOU PROGRAMMERS WHO WISH TO CONVERT APPLE SOFTWARE TO RUN ON THE ADAM. THESE CONVERSIONS WILL BE A GREAT HELP IN GETTING STARTED. WE HIGHLY RECOMMEND NIAD TO ALL ADAM USERS. THIS ORGANIZATION OFFERS A NUMBER OF SERVICES INCLUDING A MONTHLY NEWSLETTER & BUYING SERVICE. (SEE SHOPPER SECTION)

NOTE: Apple addresses are given as positive. Occasionally, they will be shown as negative (-). To calculate the positive equivalent, add 65,536
 I.E. -16384 = -16384 + 65536 = +49152

On ADAM or APPLE, 2 addresses denote Low value in first and High in second
 calculated value is Low + (High * 256)
 On some of the ADAM addresses, the normal default will be shown as (x).

Nothing for the ADAM denotes no known (as of yet) equivalent

APPLE		ADAM		APPLE		ADAM
32	Left edge	17202 (1)		216	ONERR (0 clears)	CLRERR
33	Line Width	17199 (30) from 17202		218-219	ONERR line #	16126/16127
34	Top edge	17201 (0) 1 less than actual		222	ONERR error code	x=ERRNUM(1)
35	Bottom edge	17198 (23) Lines down from 17201		225	x of last HPLOT	16763
	NOTE: I.E. 17202 = 6, 17199 = 19, 17201 = 4, 17198 = 13 and do TEXT			226	y of last HPLOT	16764
	Creates a text window from line 5 thru 18, margins being column 6 thru 25.			228	HCOLOR code	16777
	Resetting the above and doing a CALL 17197:HOME will reset the text window and ONLY clear the new window area. Text already on the screen outside the new boundaries will not be erased.			231	SCALE	16765
	The equivalents for HGR are 25577 (1), 25574 (30), 25576 (20), 25573 (3)			232-233	Shape table start addr	16766/16767
	CALL 25572:HOME for hgr text window clear (similar to text CALL 17197)			234	Hires collision check	
	-- you can increase the HGR text window to 8 lines by			241	SPEED	16129 (255)
	POKE 25576,16:REM top edge			243	FLASH speed	159 (12)
	POKE 25573,7:REM lines down to bottom then HGR.			249	ROT	
36	Cursor horz (col)	17002 or POS(0)			POKE limit	16149/16150
37	Cursor vert (row)	17001 or VPOS(0)			POKE each with 255 for unlimited address	
48	Lores color	18633 GR window			CALLS	
50	Text format			-16384	Read Keyboard	PEEK(64885)
	83 = inverse, 127 = flash, 255 = normal			-16368	Clear Keyboard	POKE 64885,0
51	Prompt Character	1146		-16336	Speaker click	PRINT CHR\$(7)
105-106	LOMEM pointer	16095/16096		-16287/285	PDL	use PDL commands
107-108	Start array space			-3288		RESUME
109-110	End array space			-3086	Clear Hires to Black	HGR or HGR2
111-112	Start string space	16111/16112		-3082	Clear Hires to last HPLOT color	
113-114	End string space	16115/16116			Move cursor right	
115-116	HIMEM pointer	16089/16090		-1036	Move cursor left	
119-120	Line # where program stopped	*		-1008	Move cursor up	VTAB VPOS(0)-1
117-118	Line # being executed	*		-998		Range 0 - 23
121-122	Addr of line # exec	*		-958	Clear text cursor-down	PRINT CHR\$(24)
	NOTE: 16124/16125 contains address pointing to the NEXT line number-token address area. The 4 bytes pointed to are 2 bytes for line number and 2 bytes for actual token instruction area. Since 16124/16125 point to NEXT line, the current line number area is the 16124/16125 address - 4 (preceding 4 block area). The first 2 bytes at that point are the line number, the next 2 is the actual tokenized instruction address.			-922	Move cursor down	VTAB VPOS(0)+1
				-868	Clear text cursor-right	Range 0 - 23
				-756	Wait for keypress	POKE 16136,0
					do inside a program. not immediate	
123-124	Current DATA line #	NOTE: 16119/16120 contains address of the current data VALUE. 16121 shows the number of bytes left of data in the current data VALUE area.		-678	Wait for return	
125-126	NEXT data address	16117/16118		-676	Bell, Wait for return	
127-128	INPUT/DATA address			-198	Ring bell	PRINT CHR\$(7)
129-130	Last used variable name	16107/16108	Has the next variable number (1st is 30) that points to the var. name/addr area.			
131-132	Last used var. addr.					

SHOPER

Text Color Table

HERE'S A HANDY TABLE TO PUT SOME COLOR IN YOUR BASIC PROGRAMS
COURTESY OF LAS VEGAS ADAM CLUB

BACKGROUND COLOR	0	1	2	3	4	5	6	7	8	9	10	11	12	13	14	15
0	0	1	2	3	4	5	6	7	8	9	10	11	12	13	14	15
L 1	16	17	18	19	20	21	22	23	24	25	26	27	28	29	30	31
E 2	32	33	34	35	36	37	38	39	40	41	42	43	44	45	46	47
T 3	48	49	50	51	52	53	54	55	56	57	58	59	60	61	62	63
T 4	64	65	66	67	68	69	70	71	72	73	74	75	76	77	78	79
E 5	80	81	83	83	84	85	86	87	88	89	90	91	92	93	94	95
R 6	96	97	98	99	100	101	102	103	104	105	106	107	108	109	110	111
7	112	113	114	115	116	117	118	119	120	121	122	123	124	125	126	127
8	128	129	130	131	132	133	134	135	136	137	138	139	140	141	142	143
C 9	144	145	146	147	148	149	150	151	152	153	154	155	156	157	158	159
D 10	160	161	162	163	164	165	166	167	168	169	170	171	172	173	174	175
L 11	176	177	178	179	180	181	182	183	184	185	186	187	188	189	190	191
O 12	192	193	194	195	196	197	198	199	200	201	202	203	204	205	206	207
R 13	208	209	210	211	212	213	214	215	216	217	218	219	220	221	222	223
S 14	224	225	226	227	228	229	230	231	232	233	234	235	236	237	238	239
15	240	241	242	243	244	245	246	247	248	249	250	251	252	253	254	255

COLORS in TEXT

- 0 = TRANSPARENT
- 1 = BLACK
- 2 = MEDIUM GREEN
- 3 = LIGHT GREEN
- 4 = DARK BLUE
- 5 = MEDIUM BLUE
- 6 = DARK RED
- 7 = CYAN
- 8 = LIGHT RED
- 9 = ORANGE
- 10 = DARK YELLOW
- 11 = LIGHT YELLOW
- 12 = DARK GREEN
- 13 = MAGENTA
- 14 = GREY
- 15 = WHITE

FRAME = POKE 17059,(color #)
LETTERS & BACKGROUND = POKE 17115,(color #)
INVERSE = POKE 17126,(color #)

Hex Decimal Conversion Table

	0	1	2	3	4	5	6	7	8	9	A	B	C	D	E	F
0	0	1	2	3	4	5	6	7	8	9	10	11	12	13	14	15
1	16	17	18	19	20	21	22	23	24	25	26	27	28	29	30	31
2	32	33	34	35	36	37	38	39	40	41	42	43	44	45	46	47
3	48	49	50	51	52	53	54	55	56	57	58	59	60	61	62	63
4	64	65	66	67	68	69	70	71	72	73	74	75	76	77	78	79
5	80	81	83	83	84	85	86	87	88	89	90	91	92	93	94	95
6	96	97	98	99	100	101	102	103	104	105	106	107	108	109	110	111
7	112	113	114	115	116	117	118	119	120	121	122	123	124	125	126	127
8	128	129	130	131	132	133	134	135	136	137	138	139	140	141	142	143
9	144	145	146	147	148	149	150	151	152	153	154	155	156	157	158	159
A	160	161	162	163	164	165	166	167	168	169	170	171	172	173	174	175
B	176	177	178	179	180	181	182	183	184	185	186	187	188	189	190	191
C	192	193	194	195	196	197	198	199	200	201	202	203	204	205	206	207
D	208	209	210	211	212	213	214	215	216	217	218	219	220	221	222	223
E	224	225	226	227	228	229	230	231	232	233	234	235	236	237	238	239
F	240	241	242	243	244	245	246	247	248	249	250	251	252	253	254	255

0100 = 256	1000 = 4096
0200 = 512	2000 = 8192
0300 = 768	3000 = 12288
0400 = 1024	4000 = 16384
0500 = 1280	5000 = 20480
0600 = 1536	6000 = 24576
0700 = 1792	7000 = 28672
0800 = 2048	8000 = 32768
0900 = 2304	9000 = 36864
0A00 = 2560	A000 = 40960
0B00 = 2816	B000 = 45056
0C00 = 3072	C000 = 49152
0D00 = 3328	D000 = 53248
0E00 = 3584	E000 = 57344

ACTIVATING THE SPRITES

Once you have created the Sprite data and Attribute table, you are ready to begin using your sprites. Since SmartBasic doesn't have commands that activate the sprites, it is done with a 40 byte machine language program. Below is an Assembly Language listing of this program, a memory mapped listing of the same program, and heavily REMarked data statements which will be loaded and used by your Basic programs.

Assembly Language Listing:

```
LD C,226 ;Select mode
LD B,1
CALL 64800
LD A,(64536)
LD IY,nnnn ;'nnnn'=the length, in bytes, of the sprite
;attribute table (d * # of sprites).
LD HL,nnnn ;Point to the first address of the Sprite
;data.
LD DE,0000 ;Clear DE register pair.
CALL 64812
LD A,(64535)
LD IY,nnnn ;# of sprites to activate.
LD DE,0000 ;Clear DE pair.
LD HL,nnnn ;Point to first address of Sprite Attribute
;table.
CALL 64812
RET ;and return.
```

Memory map for ML Sprite prog.

ADDR./DEC./COMMENTS

```
27407/ 14 /
27408/226 /
27409/ 6 /
27410/ 1 / mode (0,1,2, or 3)
27411/205 / CALL
27412/ 32 / lsb of 64800
27413/ 253/ msb of 64800
27414/ 58 /
27415/ 24 / lsb of 64536
27416/ 252/ msb of 64536
27417/ 253/
27418/ 33 /
27419/ - / poke w/attribute table length (d* # of sprites)
27420/ 0 /msb of attribute table length
27421/ 33 /
27422/ - /poke lsb of addr. of begining of sprite data
27423/ - /poke msb of addr. of begining of sprite data
27424/ 17 /
27425/ 0 /
27426/ 0 /
27427/205 /CALL
27428/ 44 /lsb of 64812
27429/ 253/ msb of 64812
27430/ 58 /
27431/ 23 /lsb of 64535
27432/ 252/msb of 64535
27433/ 253/
27434/ 33 /
27435/ - /poke lsb of the # of sprites to activate
27436/ 0 /msb of # of sprites to activate
27437/ 17 /
27438/ 0 /
27439/ 0 /
27440/ 33 /
27441/ - /poke lsb of first addr. of attribute table
27442/ - /poke msb of first addr. of attribute table
27443/ 205/CALL
```

```
27444/ 44 /lsb of 64812
27445/ 253/msb of 64812
27446/ 201/ return
27407 / first available address for attribute table.
.
.
27575 /first available address for sprite data if all 32
;/sprites used.
.
.
28599 /first available address for user program (LOMEM)
;/if 32 - 16 x 16 bit sprites are used.
```

REMarked data statements (shown for 32 -16 x 16 bit sprites)

ML loader routine:

```
15000 REM * LOAD ML PROG *
15010 faddr=27407 : REM first available address after Basic.
15020 offset=0 :REM initialize offset
15030 READ val : IF val = -1 THEN RETURN : REM check if done
15040 POKE faddr + offset,val
15050 offset=offset + 1 : goto 15030
```

```
15098 REM * ML ROUTINE DATA *
15099 REM LD C,226
```

```
15100 DATA 14,226
15109 REM LD B,1 (select mode 1 (16 x 16 bit sprites)
15110 DATA 6,1
15119 REM CALL 64800
15120 DATA 205,32,253
15129 REM LD A,(64536) (get val from addr 64536)
15130 DATA 58,24,252
15139 REM LD IY,128 (d * 32 sprites)
15140 DATA 253,33,128,0
15149 REM LD HL,27575 (begining of sprite data)
15150 DATA 33,183,107
15159 REM LD DE,0000 (HEX)
15160 DATA 17,00,00
15169 REM CALL 64812
15170 DATA 205,44,253
15179 REM LD A,(64535) (get val from addr 64535)
15180 DATA 58,23,252
15189 REM LD IY,32 (total # of sprites to activate)
15190 DATA 253,33,32,0
15199 REM LD DE,0000 (HEX)
15200 DATA 17,00,00
15209 REM LD HL,27447 (begining of attribute table)
15210 DATA 33,55,107
15219 REM CALL 64812
15220 DATA 205,44,253
15229 REM RET (return)
15230 DATA 201,-1
15231 REM (-1) signals end of ML data
```

Once your Sprite data and Attribute table is loaded starting at 27575 and 27447 respectively, and you are in one of ADAM's graphics modes, a 'CALL 27407' in your program will display your sprites. Every time you change any sprite's attributes, you will have to 'CALL 27407' to see the change. This is not to say that you must call 27407 for each individual change, but only that no change will be apparent until you call 27407.

***** SOME SPECIAL CONSIDERATIONS *****

PRIORITIES

Think of sprites as being between you and the background of ADAM's screen. There are 32 levels or planes that the sprites move on, one on each plane. Sprite # 0 moves on the plane nearest to you and sprite # 31 moves on the plane closest to the background of the screen. If sprite # 0 is moved to the same screen location as sprite # 1, then sprite # 0 will cover all or part of sprite # 1. If any two sprites are moved to the same screen location, then the lower numbered sprite will cover all or part of the higher numbered sprite.

THE FIFTH SPRITE PROBLEM

ADAM can only display 4 sprites on any horizontal row. If five sprites are moved onto the same horizontal row, then the sprite with the highest number (or lowest priority) will become covered and will not be displayed even though it is actually still there. It is up to the programmer to insure that 5 sprites are never on the same horizontal row. If you experiment with this, you will see what I mean.

TURNING OFF UNWANTED SPRITES

Let's say that you have the data for all 32 sprites loaded, but only want to use sprites # 0,1,2, & 3. Simply place a value of 208 decimal in the 'Y' coordinate position in the attribute set of sprite # 4 and all of the sprites from 4 through 31 will not be displayed.

CREATING AND SAVING SPRITES EASILY

During my quest to learn more about sprites, I modified a sprite editor that I downloaded from the Family Computing Data Library 6. The original program only allowed editing of sprites number 1 through 7. My modified version allows editing of all 32 sprites, uses less protected memory, is compatible with this sprite documentation, and will be more user friendly by the time I upload it to the DL. Look for it as 'GUTILSprite'.



USE THIS PAGE FOR NOTES...WHEN YOU COLLECT A FEW IMPORTANT FACTS...WRITE TO US AT THE ADAM RESOURCE..WE WANT TO HEAR FROM YOU!!!



the ADAM™
Resource
START UP AND GO
WITH THE ADAM SYSTEM

the



ADAM™



SHOPPER

Section

In the pages ahead you will find a record number of Adam-ads from companies & user groups who provide products and/or services for the Adam Computer System. As you support these companies you also extend the life of the Adam & insure a future of New products!

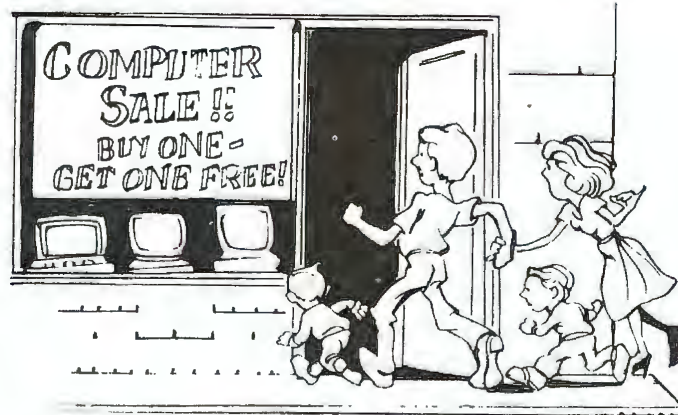

EDITOR'S NOTE: ALL DATA-DOCTOR PRODUCTS MUST BE ORDERED THROUGH "DIGITAL EXPRESS". THE DATA DOCTOR IS NO LONGER SUPPLYING THEIR OWN PRODUCTS THEMSELVES.



The **HACKER'S HANDBOOK**

over
40,000
sold!



*An Insider's Guide to
Modems and Telecomputing*

Only \$12.95

- How to figure out passwords, protocols, access codes, operating systems, etc. of remote location computers.
- Phone, Programming, and hardware tricks for zeroing in on unlisted numbers, indentifying and analyzing signals with *no physical phone tap!*
- Famous "Salami", "Trap Door", and Trojan Horse" techniques explained.
- U.S. and International technical standards including networking, packet switching, and short wave radio hacking. 169 Jam-Packed pages including charts, tables, and lists of Hacker Bulletin Boards . . . plus much more!
- This book sold over 40,000 copies (5 press runs so far) in England. Now its been revised and

updated for US technical standards. If you own a computer and modem, you'll want this book to make the most of your equipment. If you operate a Local Area Network or bulletin board, you'll want this book for security purposes. Sales here have been very brisk, so place your order as soon as possible to be sure of fast delivery.

HERE'S HOW TO ORDER:

**SEND CHECK OR MONEY ORDER (U.S.FUNDS ONLY)
\$12.95 POST PAID (note-we ship library rate)
If you want yours sent 1st Class ad \$1.00
to:**

The ADAM RESOURCE

P.O. BOX 90-H

SEELYVILLE, INDIANA 47878

(Specify HACKER'S HANDBOOK when ordering)

EDITOR'S NOTE: We offer this book to BDRM owners not condoning unlawfull practices. We simply believe it has a wealth of good information for the serious "on-line" user.

LAS VEGAS ADAM CLUB

PRESENTS

ARCHIVES I

10 UNIQUE BASIC SMART PROGRAMS

\$9.95

SNAKE EYES	A GRAPHICS DICE GAME FOR 1 to 4 PLAYERS
MATCH'EM	CONCENTRATION TYPE GAME
LETTER MATCH	MASTERMIND WITH 3 LEVELS
MORSE CODE	LEARN AND PRACTICE MORSE CODE
CATALOG P/O	CREATE CATALOGS FOR FUTURE REFERENCE
COLOR POKES	TEACHES THE USE OF COLOR WITH TEXT
CARD TRICK	CARDS ARE GRAPHICALLY DISPLAYED IN TEXT
I. Q. TEST	MEASURE YOUR I.Q. ACCURATELY
TRIVIA GAME	COMES WITH 50 T.V. QUESTIONS
TRIVIA MAKER	CREATE YOUR OWN QUESTIONS FOR USE ON TRIVIA GAME (USER FRIENDLY)

SEND CHECK OR MONEY ORDER

BLANK TAPES FOR ADAM DIGITAL DATA DRIVES **\$1.75**

(INCLUDES POSTAGE AND HANDLING) FOR MORE INFORMATION ON AVAILABLE MATERIAL, SEND A SELF-ADDRESSED STAMPED ENVELOPE TO:

**L.V.A.C.
P.O. BOX 81146
LAS VEGAS NEVADA 89103**

<SHOPPER SECTION>

NIAD Northern Illiana ADAM User's Group

PO Box 1317 Lisle, IL 60532

Multi-function User Group

MONTHLY NEWSLETTER-PUBLIC DOMAIN LIBRARY
DISCOUNT BUYING SERVICE FOR HDW & SFTW

NIAD is committed to the ADAM as our growing number of members will attest to. Why? Because we offer a full range of support services:

Hardware/Software Rev's

- We have published reviews of over 100 ADAM products.
- We spend a lot of time researching new products for our members to keep them informed of what is available and what new products are under development.
- Our staff are ADAM owners and lovers, hence we know the ADAM hardware and software.

ADAM News & Updates

We keep our members up to date on ADAM happenings such as new products under development, where to get your ADAM repaired, local user groups, where to get the answers you need.

Additionally, we work with ADAM software and hardware developers to provide input on what our members are looking for.

Workshops

Each newsletter contains various programs with tips and general education for Basic, CP/M 2.2, Logo, etc. We even have a Beginners Basic workshop for the novice to get them started with the ADAM.

Public Domain Library

Each issue contains free programs that are documented for use by members.

Additionally, NIAD has an extensive library of Public Domain Basic, CP/M 2.2, Logo and ADAMCalc games, utilities, business and educational programs. We have 100's of programs on many different volumes to choose from including a backup utility program that is required to make copies of your key tapes. These programs are available via our Software Exchange program for no charge or via direct purchase for only \$7 per tape/ \$5 per disk !!

Discount Buying Service

NIAD Stocks over 100 products for the ADAM and are constantly adding new products as we find good ones. We make up for the lack of availability of ADAM products as a service to our members that is as important as the newsletter.

Here are some of our standard products:
Ribbons - \$4.95 @ 6 for \$24.95
Data Packs - \$4.25 @ 10 for \$39.95
Data Drives - \$19.95 (re-conditioned)

Our monthly specials on software and hardware save you \$\$\$.

Support Services

- We convert your Supergames to diskette for faster loading and running and to provide a backup for \$4.00.
- We fix your SMARTBasic and other tapes for \$3.00.
- We provide you the updated versions of SMARTfiler and Basic.
- We will give you the names of other NIAD members in your local area to set up meetings.
- We answer and research technical questions.

OUR MONTHLY NEWSLETTER IS PACKED WITH 16-18 PAGES OF REVIEWS, PROGRAMS, TIPS, UPDATES AND PRODUCTS TO SATISFY ALL MEMBERS (WITH NO WASTED ADVERTISING SPACE)

**NIAD IS THE ADAM USER
GROUP FOR YOU !!**

ANNUAL FEE ONLY \$18.00

SEND A SASE FOR OUR FREE CATALOG TO:
NIAD, PO BOX 1317, LISLE, IL 60532

NIAD A CHRISTIAN

RUN BUSINESS



Finally, the true power of your ADAM can be released!! The **EVE product line** for the Coleco ADAM has been designed to enhance, and add to the capabilities of the original product. The EVE line is designed for the **serious ADAM user** who is not satisfied with a 'sophisticated game machine', but rather wants an 'affordable' **COMPUTER System** capable of using readily available software for home, business, and education. The EVE product line picks up where Coleco ended!!

Eve Electronic Systems is an independent support product developer, and is in no way associated with Coleco Industries.

SP-1 Serial / Parallel Interface Unit

Opens ADAM to the outside world! Includes RS-232C Serial, and a (Centronics) Parallel printer channels. Allows the use of hundreds of printers, high speed dot matrix, & letter quality. Use standard modems, and direct connect to other computer systems. Software for use with SmartBasic, SmartWriter & CP/M.

VD-MB 80 Column Expansion System

Use with 80 Character Monochrome Composite & some medium-to-high resolution composite color monitors

- ++ Four Expansion slots for standard EVE products [SP-1, SS-CC, (DC-1), etc.]
- ++ Optional ADAM Power Supply
- ++ Composite Video Output - Software Selectable ADAM or the 80-Column video under CP/M
- ++ Full emulation of Heath H19 video terminal.
- ++ Optional VT-100 emulation
- ++ 80-Column display & use of MOST CP/M software (ex. WordStar, DBase II, SuperCalc, etc.)
- ++ 24-Line x 80-Column Standard Display format
 - ++ Upper & Lower case with descenders
 - ++ Normal & Inverse video & GRAPHICS
 - ++ Programmable display parameters
 - ++ 7 x 9 Character matrix
 - ++ ADAM Printer jack **

SOFTWARE INCLUDED

1. Modified CP/M operating system fully compatible with ADAM CP/M.
2. True 80-Column Word Processor /Text Editor for either correspondence or program editing

3. Sophisticated, powerful 80 column CP/M word processor with advanced features like boilerplate, mail-merge, headers and footers, variables, & more. Print module allows use of special print commands for EPSON / Panasonic compatible printers, such as: superscript, subscript, **boldface**, *italic*, underline, & more.
4. SmartWriter/Filter/Calc Conversion program
5. DIRS Program to sort and display disk files
6. ZBASIC Interpreter for CP/M

(617) 653-3003

M-F 9-5 Eastern Time



Eve

Electronic Systems

2 Vernon St., Suite 404 | Framingham, MA 01701

PS-1a Power pack

Replacement unit for the supply in the ADAM printer. Allows the use of ADAM without the ADAM printer & provides power for EVE interface products.

SS-CC Speech synthesizer/clock cal

Give ADAM a 'VOICE'. Use with your programs to add capabilities to ADAM that are only limited by your imagination! Also included is a 'real time' clock calendar circuit to access time and date as needed. For use with both SmartBasic and CP/M.

ME-64 64k Memory Expander unit

'Equal to Coleco 64k Expander'. Plugs inside ADAM.

MU-2 & MU-3 Multi-unit Adapters

Use 2 or 3 EVE units at the same time

CPC-1 Printer cable assy.

Use with the EVE SP-1 & a 'Centronics' type parallel printer.

SEB-1 Serial cable assy.

Use with the EVE SP-1 when connecting to a Modem or some serial printers.

NMC-1 Null Modem Adapter

Use with EVE SP-1 when interconnecting with other computers and some printers and modems.

ERP-MOD Exp Mod #3 Conversion Kit

KIT allows ADAM Expansion Module to provide audio and composite video output for use with the VD-MB, MON-80 and composite monitors.

>>> Must be installed by skilled technician or by Eve Electronic Systems<<<

VAC-1 Video / Audio cable assy.

VD-MB or ADAM's Video 'DIN' jack to monitors video and audio inputs.

CEA-1 Card Edge Adapter

Use with MU-2 and MU-3, allows devices such as the Coleco digital dialer unit to be connected with Eve

Eve Electronic Systems is dedicated to the support of ADAM's future. In addition to our current and future products listed here, we have in planning stages several other products to upgrade and enhance the capabilities of your ADAM. Your input is necessary in helping us determine additional products for development. Please feel free to write us with your suggestions and ideas.

INFOCOM GAMES

Specially configured for the ADAM.
ZORK I ZORK II ZORK III
INFIDEL ENCHANTER WITNESS
HITCH HIKERS' GUIDE TO THE GALAXY
SORCERER DEADLINE STARCROSS
PLANETFALL SEASTALKER SUSPECT
 & Others

We also Carry:
PRINTERS
MODEMS
MONITORS
& MORE

**CALL FOR CURRENT
 PRICES AND DELIVERY**

SP-1 P
 Parallel only
 version of SP-1



Eve
Electronic Systems

(617) 653-3003

M-F 9-5 Eastern Time

2 Vernon St., Suite 404 | Framingham, MA 01701



ZBASIC Eve Electronics High Precision Z80 BASIC Interpreter for use with CP/M. Excellent implementation of BASIC similar to, but not fully compatible with Microsoft Basic. Excellent for novice and expert programmers. Complete with a 68 page users manual. **Available on Disk or DDP.**

Multiplan - Spread Sheet
Pascal MT+
PL1 Programming Language
Punctuation & Style
Quick Code - DBase II Program Generator
RH Proofreader - Spelling Checker
SpellStar - WordStar Overlay
StarIndex - WordStar Overlay
SuperSort
Word Plus - Spelling Checker
WordStar
WS ProPak - Incl. MailMerge, SpellStar

CPM SOFTWARE

MITE - Data Communications program
CP/M 2.2 - Computer operating system
Microsoft Basic Compiler
Microsoft Basic Interpreter
CBasic
COBAL Compiler
DBase II - Data Base Language
Fortran 80
Graftalk - Graphics Printer Program
Lynn - Microsoft Overlay Linker
Digital Research Macro Assembler
MailMerge

CUSTOM SOFTWARE SERVICES

Custom SmartWriter print program {for use with SP-1 and external printer}
 ++ CP/M programs transported to **ADAM disks**
 ++ CP/M programs configured for ADAM system
 ++ CP/M system driver software / custom mods.

MANY OTHER CP/M PROGRAMS AVAILABLE
**** PLEASE CALL for Catalog & Prices!!**

Eve Electronics has in development several other hardware products for the ADAM Computer system. These products will be announced when available through our catalogs. We also will consider custom interface units for special business and industrial control. For further information write to:

EVE ELECTRONIC SYSTEMS R & D, 2 VERNON ST., SUITE 404, FRAMINGHAM, MA 01701

CP/M is a registered trademark of Digital Research
 ADAM, SmartBasic, SmartWriter are trademarks of Coleco Industries
 Infocom games listed above are Trademarks of INFOCOM, Inc.

CALDERON SOFTWARE
INC.

-- 155 DEHART AVE., STATEN ISLAND, N.Y. 10303 --

CALDERON SOFTWARE, Inc. Offers you SmartBASIC Programs for the ADAM as:

- 1] LIST FORM.
- 2] DISK FORM.
- 3] DDPACK FORM**.

All software forms contain 10+* Programs with instructions on how to use them. There are graphical, educational, and entertainment Programs. All of the Programs have been enhanced with various background colors and bell sounds, since the first time they were created, to give them more life and enjoyment as well as to the user. All the Programs are originals of CALDERON SW with the exception of SKI-TREK which was taken from the '84 issue of Family Computing and modified for ADAM. This Program is charged only for the printing or transferring of it to paper, disk, or data-Packs. Each Program averages \$1.40 Plus .50 cents for the SKI-TREK Program...a total of \$13.50 for all 10+* Programs. We provide listing Programs for those who enjoy typing and learning BASIC at the same time. The Disk form is for those who like to have the convenience of quick access to their BASIC Programs. Digital Data Pack** for those who don't have the Disk Drive yet but like a little quickness. Here are the names of the 10+* Programs and a brief description of them...

WORD-CRAZE

Guess the word the computer Picks out of 20 (words can be changed).

CHOPPER

A Hi-Res scenery of a chopper with Propellers that move.

SUMS

The computer Predicts a final sum after you input the first number!

HGRTeacher

The computer will attempt to teach you the basics of Hi-Res Plotting.

H-GR-COMBO

A colorfull combination of Hi-Res and GR graphics and designs.

CNAPS-GAME

The casino game that simulates dies and tells you the results.

SKI-TREK

This is a modified version for the ADAM taken from F.C. '84 issue.

TYPETUTOR

Increase your typing speed by Practicing with this computer Program.

CHARACTERS

A listing of the 255 ADAM charact., good for the serious Programmers.

COLORS

Enhance your background/foreground colors while in BASIC (256 combos)

PGMRUNNER

A Program that catalogs Disk/Tape and loads/runs Programs for you.

Terms for Purchasing software:

* = The extra Programs are only available on disk or DD-Pack, NOT on list.

** = YOU MUST SUPPLY A BLANK DIGITAL DATA-PACK ALONG WITH RETURN POSTAGE.

SO THAT WE CAN RETURN IT TO YOU. WITHOUT IT YOU WON'T GET YOUR TAPE.

THE PRICE FOR SOFTWARE ON YOUR DIGITAL DATA-PACK IS \$12.00 ONLY.

(Software on DD-Packs are the same as the Disk orders).

PLEASE MAKE CHECKS OR MONEY ORDERS (SORRY NO C.O.Ds) PAYABLE TO:

D. CALDERON. (USE ABOVE ADDRESS).

ADAM and SmartBASIC are trademarks of COLECO INDUSTRIES.

(c)1986 CALDERON SOFTWARE, INC.

All Printing on this ad was done with an ADAM computer

ADAM SOFTWARE

SmartTYPE V1.1: Word processor written in SmartBASIC. Features: Left and right line justification, center, auto/fast-loading, one or two column printing, bi-directional printing, SmartKey menu driven, and more!

DATA PACK - \$24.95 / DISKETTE - \$22.95

KopyKat: Great backup utility copies data packs and disks. Copy SmartBASIC to work on disk. Successfully backup most ADAM software: SmartBASIC, ADAMCalc, SmartLOGO, SmartFiler & data bases, etc.

DATA PACK OR DISKETTE - \$19.95

The Reedy Library: Collection of many SmartBASIC programs. Includes: Michigana Jones text adventure, VideoPAINT, TextEDITOR, Subroutine Maker, and more.

DATA PACK - \$24.95 / DISKETTE - \$22.95

The Reedy Entertainment Pack 1: Many great games! All are menu driven and include excellent sound and graphics. Includes: **Connect Four, Blockade, and Slide Puzzle.** One- and two-player games.

DATA PACK - \$21.95 / DISKETTE - \$19.95

WE ALSO CARRY THESE SOFTWARE PACKAGES BY DATA DOCTOR:

SmartBEST V1.0: Adds many great enhancements to SmartBASIC. Adds sound commands for all three voices and sound generator, video enhancements and much more!

DIGITAL DATA PACK - \$18.95

SmartTRIX I: Very comprehensive utilities for ADAM programmers. Includes Sound Effects, Tune Maker, Sprite Maker and Sprite Animator (the two most sophisticated sprite creation/usage programs for ADAM), and much, much more! NOTE: Many references are made to SmartBEST, so you will probably want to buy it also.

DIGITAL DATA PACK - \$34.95

Strategy Strain I: Collection of advanced versions of nine computer classics. Includes: Klingon Challenge, Lunar Module Simulation, Towers of Hanoi, Scrambler, and more.

DIGITAL DATA PACK - \$24.95

All prices include postage. Send a self-addressed, stamped envelope for our current catalog. To order, send check or money order to:

**REEDY SOFTWARE
10085 60th Street, S.E.
Alto, Michigan 49302**

<SHOPPER SECTION>

Marathon Computer Press Delivers...

(POWER)

PRODUCT DESCRIPTION

THE INVESTMENT ANALYST:

A menu driven collection of 6 programs written in SmartBASIC for the ADAM. The programs include:

1. Mini-Glossary of terms.
2. PE Ratio computation, & projection.
3. Earnings Per Share projection & growth.
4. Portfolio Growth.
5. Ten Day Moving Graph.
6. Mini-Transaction DataBase.

CODEVISOR 4.1 & CODESCRIBE:

The first dedicated data security system of it's kind developed for the ADAM. With CODESCRIBE you may limit access to the use of SmartBASIC on your computer. (Allows up to 2 separate passwords per system). And with CODEVISOR you can securely lock an entire data tape or disk from prying eyes. CODEVISOR works with SmartBASIC, SmartLOGO, ADAMCalc, & SmartWriter data storage mediums. With CODEVISOR you get; Color Screens, Advanced Screen Presentations, Multi-Drive Capability, & an in depth Users Manual. No ADAM software library would be complete without this program.

THE SPANISH VOCABULARIAN:

This program was a MARKET BUSTER in the area of ADAM foreign language applications. The package includes a Data Base Manager Program, a Data Base Utility, and a Data Base of 1600 vocabulary words. Some features included are; Color Screens, Menu driven application, an Electronic Dictionary, Advanced sequential text file handling, and the choice to Print or Create Files. This is the front runner in a planned series of vocabulary programs. A steal at this price.

WE ALSO CARRY HW & SUPPLIES IN QUANTITY, SEND FOR OUR PRICES !!
FOR ALL READERS OF THE ADAM RESOURCE:

YOU WILL QUALIFY FOR A 15% DISCOUNT ON ANY OF THE THREE LISTED PROGRAMS SIMPLY BY SAYING YOU SAW OUR AD HERE AND INCLUDING THE FOLLOWING CONTROL NUMBER WITH YOUR ORDER. (Discount is not good with any other discounts that you may qualify for. Discount only applies to software by MCP.) CONTROL NUMBER (ADAMR86870) ALL prices listed on previous page are in U.S. Dollar amounts and are payable by check, or M.O.. Checks require 10 days to clear.)

We Carry Software From Some Of The Leading ADAM Suppliers.

ADAM, ADAMCalc, SmartLOGO, SmartBASIC, & SmartWriter are reg. TM of COLECO IND INC. MCP is not affiliated with COLECO.

ADAMtm

SW&HW

THE INVESTMENT ANALYST
Disk 22.50 / DDP 25.50

CODEVISOR 4.1
Disk 25.00 / DDP 28.50

THE SPANISH VOCABULARIAN
Disk 22.50 / DDP 25.50

FUTURE :

UTILITIES
GRAPHICS

◆ **SASE FOR LATEST** ◆
CATALOG.....

MARATHON COMPUTER PRESS
P.O. BOX 68503
VA BEACH, VA
23455

<SHOPPER SECTION>

T-SHIRT DECAL



\$5.00 EACH

SPECIALLY DESIGNED FOR THE ADAM COMPUTER USER...

SIZE OF DECAL 8" x 11"

3/4 WEEKS DELIVERY <> MONEY ORDERS <> CHECKS <> U.S. CURRENCY ONLY

SEND ORDERS TO:

**JOHN F. BOSBY II
6634 SW 41st STREET
DAVIE, FLORIDA 33314**



SHOPPER SECTION

FOR ALL ADAM COMPUTERS AND OTHER COLOG
PRODUCTS SEE THE STORES LISTED ON THE
COLOG IDENTIFIERS

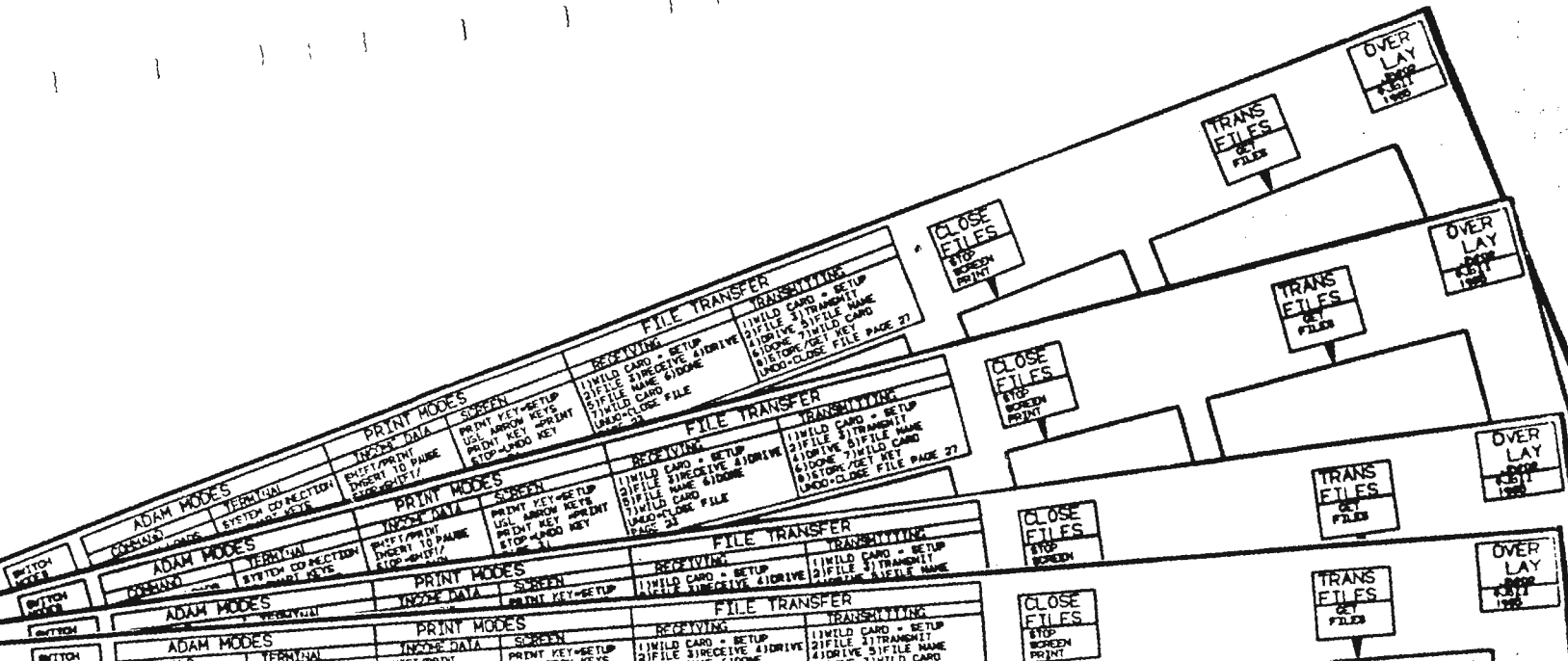

ADAM KEYBOARD OVERLAYS

<> THERE ARE MANY WAYS TO REMEMBER HOW TO OPERATE A PROGRAM <> ONE WAY IS TO SEE THE INFORMATION AT A GLANCE <>
 <> THERE ARE (16) FINISHED AT THIS TIME
 (1) AUTO-AID:(2) ADAM LINK:(3)ADAMS WORD PROCESSOR:(4)SMART-TYPE W/P:(5)VIDEOTUNES:(6)SMARTSPELLER:(7)FAST-FILER:(8)DATA-CALC:(9)DESK-SET[B]:(10)DESK-SET[M]:(11)DESK-SET[F]::-----
 (12)SMART FILER:(13)RECIPE FILER:(14)SMART LETTERS & FORMS
 :(15)FINANCE/LOANS:(16)PAINT MASTER.....

PRICES

ALL (16) FOR \$11.00 OR EACH ONE FOR \$1.25

<> ORDER BY THE NAME OF THE KEYBOARD :: OR FOR ALL ASK FOR THE SET ::
 3/4 WEEKS DELIVERY<>MONEY ORDERS<>CHECKS<>US CURRANCE ONLY
 SEND ORDER TO JOHN F BUSBY II

6634 SW 41ST.STREET
 DAVIE,FLORIDA 33314

ADAM & LINK II
 REGISTERED TRADEMARK
 COLOG INDUSTRIES

ADAM OVERLAY
 COPYRIGHT
 8/11/1985 B#2

ADAM LINK II TELECOMMUNICATION GUIDE

P = PAUSE/DIALING
 S=START TRANSMIT
 S=CTRL-STOP TRANSMIT
 CTRL-CONTROL KEY

HOME KEY
 CLEAR SCREEN

DOWN ARROW
 SCROLLS SCREEN
 IN RIGHT FILE

PAUSE USED IN BOTH PRINTER AND DISPLAY MODE
 USED IN BOTH PRINTER MODE
 UP ARROW
 SCROLLS SCREEN IN RIGHT FILE

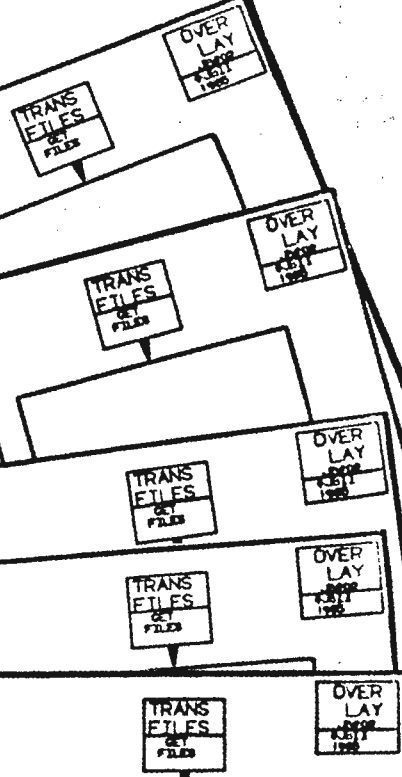

A D A M L A N D

INTERNATIONAL ADAM USER GROUP

LOCAL NATIONAL INTERNATIONAL "ADAM" NEWS & SUPPORT
NEWSLETTER TECH UPDATE

DEDICATED SUPPORT TO THE "ADAM" COMPUTER, AND "ADAM" USERS

One year dues includes your membership and 12 monthly issues of our fine newsletter, "The ADAMLAND News" with "ADAM" Related Tech Updates, Hints & Kinks, Games, Programming, Graphics, buying information on Hardware, Software, Peripherals, New Product Reviews, Glitches & Gremlins, and Consign-A-Bit sections, ALL letters requiring an answer must have a LARGE DOUBLE STAMPED self-addressed envelope included, or Postal Reply Coupons, or coin to cover mailing. Brochures require double postage, and are also included in our newsletter, along with the latest reports of what is ready for sale, progress on items under construction, and in Research & Development.

The only persons on our regular mailing list, and receiving special offer, or rare bargain mailings are our members.

As a group, our buying power is great. Members benefit from exchange of news, ideas, and ability to purchase at a discount.

U.S. Membership & 12 monthly issues, \$20.00

APO's, FPO's, GPO's, PUERTO RICO, CANADA, MEXICO, \$25.00
Membership & 12 monthly issues,

FOREIGN Membership & 12 issues, By Regular Mail, \$30.00
By AIRMAIL: Write us.

THIS IS NOT THE NEWSLETTER, BUT AN INVITATION TO MEMBERSHIP

ADDRESS: ***** ADAMLAND *****
795 Garfield
Lander, WY-USA
82520

Editor: Buck A. Rogers



CHALLENGE WARE

NEW! PLOT & PRINT - Design a picture in low resolution graphics and then print it out with your letter quality printer. (BASIC NEEDED)

NEW! DUNGEON ADVENTURE - Make your own dungeons and different characters. Use the keyboard and joystick. Composed of three different programs. (BASIC NEEDED)

NEW! LOUISIANA JONES - Guide Jones through the swamps and then through the dangerous land. (LOGO NEEDED)

NEW! SPACE RESCUE & MINI GAME CREATOR - First, rescue the astronauts and then make your own game in LOGO! (LOGO NEEDED)

NEW! WAITER! - Take the orders and then deliver them to the correct table. (LOGO NEEDED)

Also available:

BASIC:

CASTLE OF DOOM - Medieval text adventure.

DRAGON'S CAVERN - Fantasy graphics game.

RESUME - Instant personalized resume.

DATAKEEPER - A versatile data base.

ADAMBANNER - Create banners.

LOGO:

DUEL - Control your knight to duel the computer or another player.

KEYMAN - Help keyman deliver his keys.

APPIAN WAY - Drive your chariot on the Appian Way.

ANY THREE PROGRAMS FOR \$19.95, CHECK OR MONEY
ORDER - SPECIFY DISK OR DIGITAL DATA PACK ---
Challenge Ware 5801 Foxboro NW Canton, Ohio 44718
(216) 494-6870

EXCELLENT PROGRAMS - SUPPORT AFTER BUYING - NO S/H CHARGES - FAST DELIVERY

BASIC MANAGER - Datapack or Disk US\$ 15.95

Make SmartBASIC more user friendly with these enhanced utilities. Special binary file loads very fast from SmartBASIC. Excellent looking display shows current drive number, free space remaining, volume name, and all SmartBASIC, SmartWRITER, and FASTRUN file names on one screen (read automatically from directory block of datapack or disk). Uses the arrow keys to select the file names and Smartkeys to select the utilities. Some of the utilities and features are listed below.

- Internal help screens.
- Lock or unlock files.
- Rename file or volume names. Rename the volume name without having to initialize the datapack or disk.
- Recover SmartBASIC, SmartWRITER, and FASTRUN backup files. Recover SmartWRITER and FASTRUN type "h" files without having to use SmartWRITER.
- Run regular or FASTRUN type SmartBASIC programs. Memory is automatically reset to normal to allow you to run even the largest programs.
- Load regular SmartBASIC programs. Memory is automatically reset to normal to allow you to load even the largest programs.
- Clear memory and goto SmartBASIC or SmartWRITER.
- Reselect drive to view. All datapack and disk drives are selectable.
- Change the screen and border colors.
- Delete or undelete files. Special UNDELETE feature restores files you may have accidentally deleted.
- Catalog. All system and normal file names are displayed on one screen along with file type, file size, and an "*" for locked files. Options are included to show each file names' starting block or amount of unused space.
- INITIALIZE drive. This utility safely and correctly initializes SmartBASIC, DISK MANAGER, ADAMCALC, or ADAMLINK, on datapack or disk, with the option to save or delete these programs. Also initializes normal datapacks and disks.
- Make multiple utility changes with only one drive access.
- Includes optional parallel printer drivers. These are placed in an area of memory so memory reconfiguration is not necessary.

FASTRUN - Datapack or Disk US\$ 15.95

Unique utility program. Load and save SmartBASIC programs super fast. Help extend the life of your datapacks, disks, datapack drives, and disk drives by avoiding excessive stopping, starting, and rewinding during program loading. Easy to use. A must for all SmartBASIC users. FASTRUN has the following features.

- Save any SmartBASIC program in memory up to 4 times faster than normal.
- Load or run converted programs up to 11 times faster than normal. For example, a 24 block program which normally takes 5 minutes to run on datapack (1 min. 50 sec. on disk), will now run in just 32 seconds (10 sec. on disk).
- Once FASTRUN is loaded into memory, it will remain there allowing easy program conversion by just keying in "fr" when needed.
- Converted programs work the same and may be modified then resaved with FASTRUN and/or SAVE.
- Converts commercially written SmartBASIC programs.
- Stops DATA and REM statements from growing in length each time the program is resaved.
- Reduces the storage size of larger programs.
- Automatically saves current screen colors with the program (no need for calculating peeks and pokes).
- Includes program to easily change screen colors.

BASIC MGR PACKAGE - Datapack or Disk US\$ 25.95
BASIC MANAGER with FASTRUN. A great combination. Save \$5.95.

>>>> SEE ORDER INSTRUCTIONS IN OUR OTHER AD <<<<

PRACTICAL PROGRAMS

P.O. BOX 244, KALAMAZOO, MICHIGAN 49005

EXCELLENT PROGRAMS - SUPPORT AFTER BUYING - NO S/H CHARGES - FAST DELIVERY

MULTICART BACKUP

SPECIAL: Orders received before 8/86
Save wear and tear on your cartridges and cartridge port. Forget about having to power off and on to change games. Backup most ColecoVision compatible game cartridges to datapack or disk. Up to eight cartridges on datapack or five on disk. Special binary file loads fast from SmartBASIC and makes self-loading, 100% machine language backups. Game title directory loads in a flash. Select games with any Coleco or Atari compatible joystick. Allows game title directory printout to printer. Easy to use.

- Datapack or Disk US\$ 12.95

- Datapack or Disk US\$ 10.95

12' NETWORK CABLE - US\$ 6.95

12 foot straight cable to go from the keyboard or disk drive to the memory console. Allows you more freedom to move the keyboard or disk drives around.

25' NETWORK CABLE - US\$ 10.95

25 foot straight cable to go from the keyboard or disk drive to the memory console. Allows you more freedom to move the keyboard or disk drives around.

ORDER INSTRUCTIONS

- Specify DISK or DP (Datapack) when ordering software.
- C.O.D. (cash on delivery) orders are being accepted for US addresses only. Add \$1.50 to your total order for this service.
- C.O.D. phone orders are taken Tuesday through Thursday, 6pm to 12pm Eastern (3pm to 9pm Pacific) time at 1-616-345-0665. Sorry, no collect calls accepted.
- To pay in Canadian dollars, add \$2.00 (bank conversion charge) to the US dollar total then multiply by 1.4 for your Canadian dollar total.
- No extra charges for Canadian orders in US dollars.
- New FASTcheck service (US addresses only) speeds up verification of your personal checks for faster delivery. Add \$1.50 to your total order and follow these instructions when using the FASTcheck service:
 1. Check must have complete address.
 2. Signature must be identical to the IMPRINTED name on check.
 3. Check must have your valid drivers license number and issuing state.
 4. Check must have your telephone number and area code.
- C.O.D. requests, personal checks using the FASTcheck service, money orders, and certified checks are mailed in 2 working days. Personal checks without the FASTcheck service are mailed in 10 working days.
- No credit cards accepted.

Write for current information, or send orders to:

**PRACTICAL PROGRAMS
P.O. BOX 244
KALAMAZOO, MICHIGAN**

49005

ColecoVision, SmartBASIC, SmartWRITER, ADAMCALC, DISK MANAGER, and ADAMLINK
- trademarks, Coleco Industries

BASIC MANAGER, FASTRUN, and MULTICART BACKUP
- trademarks, Practical Programs

<SHOPPER SECTION>

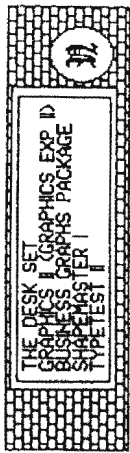

Artmotion

Hi-Res Graphics



THE GRAPHICS EXPERIMENTER II

Includes elaborate SINE-COSINE "3-D" ART, Totally Unique ARTHOTION GRAPHICS with hundreds of variations of computer generated graphics, RABBIT GRAPHICS sine-cosine automatic drawings of planets, impossible figures, etc., ARTISTS PAD use the paddle as a drawing tool with color change and special figures controlled by the pad., ARTISTS KEYBOARD Lets you combine figures from ARTHOTION and RABBIT GRAPHICS on screen with its own special draw keys. SAVE up to 800 keystrokes, DEFINEABLE DRAW MACRO KEY. \$39

HI-RES TEXT EDITOR

HI-RES TEXT EDITOR Lets you use text on the hi-res screen. Includes its own limited graphics including multiple boxes to put text inside, and multicolored symbols. Add to your own programs (some basic skill needed to add). Create multiple screens with any format....\$29

ShapeMaster

SHAPEMASTER Teaches even beginners the basics of animating, positioning, paddle control, and creating your own spaceships, rockets, and little critters. Includes 22 page manual and eight short listable, printoutable programs as demonstrators (includes Gallery, SkyWriter, Cartoon, Fighter, Crusade, ShapeDemo, ShapeEdit, and Paddle programs to help you make, edit, and move shapes....\$29

TYPETEST II

TYPETEST II Helps you learn the basics of touch typing or more advanced speed and skill tests. Includes multiple levels of six modules including Most Commonly Misspelled Words, Most Common Words, Most Difficult Words. Lets you add your own words and sentences to the program.

Graph-Stats

THE BUSINESS GRAPHS PACKAGE Plots 24 variables, in six multicolor styles, titles, "3-D" style, print dump to ADAM's printer using symbols. NEW! STATISTICS PACKAGE: Automatically calculates sum, averages, standard deviation, variance, projected estimate of future values, projected average. Printout of all statistics....\$29

CASHFLOW FINANCIAL PACKAGE

NOW A CASHFLOW FINANCIAL PACKAGE TO HELP YOU MANAGE YOUR ENTIRE HOME OR OFFICE FINANCIAL NEEDS. Multicolor screens, Smartkey referenced, menu driven, with save and recover, printout of individual files or financial data, inventory and invoices, and financial data. We believe this is the easiest program to use we have seen.

THREE NEW PROGRAMS HELP YOU KEEP TRACK OF YOUR FINANCIAL RECORDS:

- 1 THE BOOKKEEPING RECORD
- 2 INVENTORY/INVOICE RECORD
- 3 FINANCIAL DATA CALCULATIONS

DESK SET

Nickelodeon Graphics

THE DESK SET: B-DESK, M-DESK, F-DESK are the easiest to use we have ever seen. Works fast even with only one datapack. No switching or repeated access of DDP needed. These are already pre-formatted into useable modules. NO NEED TO GROPH AROUND TRYING TO FIGURE OUT HOW TO MAKE A DATABASE! These are ready to use, SmartKey referenced, menu driven, with full prompts!

B-DESK: Keep a client file including names and addresses, phone, sales, business, date, comments. Full SAVE, RECOVER, SEARCH, CHANGE, features. Alphabetize. Up to 10 fields per record, 120 characters per field, up to 140 records per save. Up to 3,300 records can fit on a datapack. LABEL MAKER LETS YOU DUMP THE NAMES AND ADDRESSES TO MAILING LABELS, or save your own return address labels on ADAM's Printer....\$20

M-DESK: Calculate, file, budget: M-DESK has six quick modules (including Appointment notepad, budget, credit cards, checking) available at the press of a button. Automatically computes avg, averages, balance, percent of any field at the press of a button....\$20

F-DESK: Free Form, Idea Organizer. Lets you create your own format and data base, saves any organization you use for future recall. Calculates tool! Type in any data, up to a page and a half per record, search for any beginning key words to bring together the ideas you have....\$20

SUPPR SPECIAL: ALL THREE OF THE ABOVE PROGRAMS ON ONE DATAPACK, Inc. 24 page manual, for only \$39.98!

business

SEND .44 STAMPS FOR COMPLETE CATALOG, DESCRIPTIONS, AND TO GET ON OUR MAILING LIST FOR SUPER SPECIAL OFFERS!

ADVERTISED IN FAMILY COMPUTING MAGAZINE SINCE 1984

N Nickelodeon Graphics
Computer Software
5640 West Brown
Glendale, AZ 85302

SOFTWARE (OR DATAPACKS)	PRICE	QUANTITY	TOTAL
1 GRAPHICS I (GRAPHICS EXP II)	\$39		
2 TYPETEST II	\$25		
3 THE BUSINESS GRAPHS PACKAGE	\$29		
4 HI-RES TEXT EDITOR	\$29		
5 SHAPEMASTER	\$29		
6 TONERAKER (sold only with 4 or 5 on same datapack)	\$8		
7 B-DESK (Client file, mail print)	\$19.95		
8 F-DESK (Freeform, Idea)	\$19.95		
9 M-DESK (file, notepad, idea org)	\$19.95		
10 THE DESK SET (Special offer: B, M, and F DESK's all 3 on 1 datapack)	\$39.95		
11 CASHFLOW BOOKKEEPING RECORD	\$19.98		
12 INVENTORY/INVOICE RECORD	\$19.98		
13 FINANCIAL DATA CALCULATIONS	\$19.98		
14 CASHFLOW FINANCIAL PACKAGE (ALL THREE OF THE ABOVE PROGRAMS ON ONE DATAPACK)	\$39.98		
15 ADAM compatible DDP, highest quality w/guide liners	\$3.98		
Each of 512 datapacks \$3.98 ea. plus \$3 plus tax in Canada!			

NAME: _____ Postage & Handling _____
 ADDRESS: _____ Total Price _____
 CITY: _____ STATE: _____ ZIP: _____

ADD \$1.50 each for Postage & Handling (\$3 U.S. in Canada)
 All datapacks contain programs of substantial length. Each comes with its own manual or instruction booklet. All are Smartkey referenced, menu driven, and integrated to make them easier to use.
 *ADAM is a trademark of Coleco Industries.

SPECIAL OFFER!!!

SPECIAL OFFER!!!
 THE COMPLETE DESK SET!!!
 P-DESK: Client file, mail printer, M-DESK: Calc, budget, P-DESK: Free file, idea organizer!
 PLUS THE BUSINESS GRAPHS PACKAGE!!! (24x, 6 styles, statistics package, printout graph).
 A \$68.95 VALUE, BOTH FOR ONLY \$49.98 (MENTION WHERE YOU SAW THE AD)

SPECIAL OFFER!!!
 BOOKKEEPING RECORD
 INVENTORY INVOICE
 FINANCIAL DATA CALCULATIONS
 CASHFLOW FINANCIAL PACKAGE (ALL THREE ON ONE DATAPACK)
 \$39.98

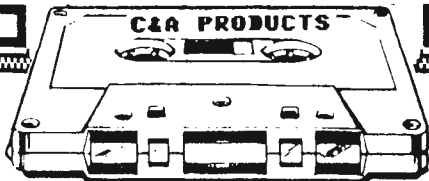

FROM C&A PRODUCTS

A NEW & IMPROVED

DATA-PACK FOR ADAM

A HIGH-PERFORMANCE DIGITAL DATA-PACK DESIGNED PRIMARILY FOR WORD-PROCESSING OF 1-TO-3-PAGE DOCUMENTS. COMPARED TO EXISTING ODP'S, IT OFFERS FASTER & SMOOTHER TAPE OPERATION, & IN ONE VERSION ALSO INCREASED FILE CAPACITY.

FOR A SAMPLE ODP, SEND \$4.50 (INCLUDES SHIPPING & HANDLING) TO: C&A PRODUCTS, RR 2, BOX 552, ROLLA, MO 65401

READ THE SMALL PRINT BELOW FOR DETAILS...

A better performing "blank" tape has been developed for the Coleco ADAM computer. A format overlay is applied that results in faster STORE and GET times (up to 60X), smoother tape handling, and more file capacity (up to 170X for Type 3S). These tapes are tailored for the word processing (WP) of short documents. As you well know, the ADAM has its limitations in working with long files. Compared to other WP's, it is sluggish editing files much longer than a few pages. While editing a 35-page document, ADAM required 85 seconds to insert one word and over 90 HOME key taps to scan it! Besides, short files can easily be merged later to form much larger documents. All other tapes use the memory space quite inefficiently, and they invariably operate slower, when mostly short files are entered. For those who still prefer using long files, or want to store mainly long computer programs, three of these types can be initialized to perform the same as the ADAM tapes (Types 1). One version, Type 1C, is identical to the ADAM tape and yet retains most of the smoother operation.

The most noticeable improvement in this smoother tape handling. Gone completely are the bone-chilling stops at the very end of the tape, and throughout the tape travel the stops and starts are a little more gentle. The smoother performance is retained even if the tape is initialized to produce the Coleco ADAM tape equivalent. After the first few files, those remaining will display about a sixty percent faster response in both the STORE and GET functions. When the tapes are initialized this higher-speed performance is lost.

As for file capacity, Type 1 tapes have slightly less, while Type 243 tapes have considerably more than the ADAM tapes. The various types are compared below.

Type	Max Files	Optimum File Length
1C	35	None
1S	32	0.5 to 2.0 pp
1M	32	1.0 to 4.0
1L	32	1.5 to 6.0
2S	60	0.5 to 2.0
2M	60	1.0 to 4.0
3S	90	0.5 to 2.0

The page length is taken to be 2700 characters which is typical of full pages that are single-spaced. There will always be a few file locations that can accommodate files somewhat longer than those indicated above. Types 1C, 1S, and 1M are ready now; Types 2S, 2M, and 3S soon will be. Type 1L will be available later as per consumer demand.

Which type would be appropriate to start using? Some suggestions may be helpful. If you feel you have little or no need to initialize or copy these tapes, then Type 2S may be your best choice, otherwise Type 1S or 1M should be chosen depending on your anticipated file length. If you prepare only an occasional long document, remember it can be STORED to a Type 1C or ADAM tape, leaving the Types S & M tapes for your more frequent short documents. Type S is somewhat faster than Type M, and Type M, somewhat faster than Type L. If you are still uncertain, try one each of Types 1S, 1M, and 2S.

The tapes are copied from carefully prepared masters using high quality audio cassette decks operating at standard speed. Some modifications include replacing the record heads and introducing certain electronic changes to promote reliable copying and the smoother tape handling characteristics. Each copied tape is individually tested in the STORE and GET modes to assure reliable performance. A thirty-day warranty applies to any malfunction, but is limited to the cost of the tape.

The following prices INCLUDE all shipping and handling to anywhere in the continental US. Add 5% for Alaska, Canada, Hawaii, and Mexico. Iowa residents should add 4% sales tax.

Quantity	Types 1	Type 2S	T 2M43S
1 to 4	\$4.20	\$5.20	\$6.20 ⁸
5 to 9	3.60	4.60	5.60
10 to 24	3.30	4.30	5.30

Want to lower your printing costs? Typically the Coleco printer ribbon may cost five cents a full sheet. Send \$2.00 for fully illustrated instructions on how you can modify the cartridge in about 15 mins to reuse the ribbon without ANY ribbon rewinding. Subsequent reuse will require less than 5 mins, and again NO rewinding. No special tools or skills are needed. This will be included free with all orders for three or more tapes.

**C&A PRODUCTS
RR 2 BOX 552
ROLLA, MO 65401**



1671 EAST 16th STREET, SUITE 146
 BROOKLYN, NEW YORK 11229
 (718) 336-7612

SOFTWARE FOR THE ADAM

CP/M 2.2 & Assembler (Data Pack) \$45

ADAM CP/M Software for ADAM

These programs require CP/M 2.2 software and an ADAM Disk Drive.

INFOCOM

Zork I	\$39.95	Zork II	\$44.95	Zork III	\$44.95
Deadline	\$49.95	Planetfall	\$39.95	Starcross	\$49.95
Enchanter	\$39.95	Infidel	\$44.95	Sorcerer	\$44.95
Suspended	\$49.95	Witness	\$39.95	Suspect	\$44.95
Cutthroats	\$39.95	Wishbringer	\$39.95	Seastalker	\$39.95
Hitchhikers Guide to the Galaxy	\$39.95				

ADAMCalc (Data Pack) Originally \$39 — Now \$25

The perfect tool for forecasting profits, planning stock portfolios, IRA's, family budgets, analyzing real estate, evaluating loans, calculating statistics—even working out income taxes. Accounting spreadsheet program.

SmartLOGO (Data Pack) Originally \$47 — Now \$29

Program up to 30 turtles and 16 colors for dazzling graphics effects. Blend in sound effects and music to create your own computer games.

SmartFILER (Data Pack, Disk) \$16

Organize personal and business records the easy electronic way. Create your own files, arrange them, sort, search, and print them quickly & easily.

ExperType (Data Pack, Disk) Originally \$39 — Now \$25

Designed to help improve the accuracy and speed of any typist. Self-adjusting program develops a constantly updated profile on every user and then customizes exercises based on individual needs.

Smart LETTERS & FORMS (Data Pack, Disk) \$19

This software gives you sample letters for social and personal letters, and business letters. Use the entire sample, or take phrases from it to compose your own letter.

Electronic FLASHCARD MAKER (Data Pack) \$19

*FLASH FACTS: VOCABULATOR (Data Pack) \$ 9

*FLASH FACTS: AMERICAN HISTORY (Data Pack) \$ 9

*FLASH FACTS: TRIVIA (Data Pack) \$ 9

*Note: Flash Facts Requires Electronic Flashcard Maker.

Richard Scarry's Best Electronic WORD BOOK Ever! (Data Pack) \$19

Ages 5-12 Increases reading readiness skills, expands vocabulary, and builds object recognition.

Recipe Filer (Data Pack, Disk) \$16

It's three files in one: file your recipes by name, type of meal, main ingredient—simultaneously. When you find the recipe you want, ADAM will print out a shopping list.

WACKY WORD Games (Data Pack) \$17

Ages 8-14 Allows you to explore all aspects of SmartWriter. Learn to INSERT, MOVE, DELETE, SEARCH, REPLACE, as you use these functions to solve anagrams, ciphers and codes.

Best of Broderbund (Data Pack) \$19

A.E.—deadly flying rays from an alien world. They hunt in swift killing packs and their sting is deadly. You've got to blast them with your twin-barreled Stun Gun before they zap you.

Choplifter—Your mission: rescue 64 kidnapped peace delegates without getting killed. Then choplift them home, dodging enemy tanks & jets. It's a good thing your chopper is loaded with firepower—because more than one trip is necessary.

Family Feud (Data Pack) \$19

Super ZAXXON (Data Pack) \$19

Super Donkey Kong (Data Pack) \$19

Super Donkey Kong Jr. (Data Pack) \$19

2010 Strategy (Data Pack) \$19

Dragon's Lair (Data Pack, Disk) \$19

ZAXXON (Disk) \$19

32 Basic Programs for The ADAM/Coleco Home Software Originally \$36 — Now reduced to \$29

Book/Software Package. Same package as the Coleco Home Software Library selling elsewhere for \$65. Program includes: Applications: biorhythm, checkbook, loan, mileage, quest/exam. Educational: arithmetic, flashcard, metric, numbers, tachist, vocab. Games: decode, groan, jot, obstacle, roadrace, wari. Graphics: kaleido, sparkle, squares, wallons. Mathematics: curve, diffeqn, graph, integrate, simeqn. Miscellaneous: birthday, PI, powers, pythag.

*Please note that all Coleco items are genuine Coleco items and are factory sealed and are not pirated copies.

HARDWARE FOR THE ADAM



- ADAMLink Direct Connect Modem** \$75
A full-duplex, 300-baud, autodial modem that connects directly to the phone line without additional interfaces or clumsy receiver cups.
- Extra Digital Data Drive** \$29
With the extra data drive, ADAM's on-line storage capacity is doubled allowing up to 500K bytes of data to be stored on two data packs. Eliminates the need to stop and change data packs in order to access, copy or transfer stored information on two separate data packs. Also can be used to replace a defective data drive on any ADAM.
- 64K Memory Expander** \$59
Increases ADAM RAM by 64K bytes for a total of 144K. Increases the workspace capacity of SmartWRITER Word Processor by 64,000 characters . . . approximately 32 pages of double-spaced text. Use with CP/M software to provide ultra-fast data storage and retrieval with compatible programs.
- Expansion Module #1** \$39
With Expansion Module #1 you can enjoy the entire Library of existing game cartridges that are compatible with the Atari Video System, as well as the SearsVideo Arcade System.
- Adjustable Tractor Feed Assembly** \$75.00
A tractor feed attachment for use on the ADAM SmartWRITER printer. Allows the use of continuous feed paper without the worry of slipping, bunching or double printing. Fully adjustable from 9½" to 2" sheets. Installs in seconds with no tools.
- Printer Stand/Front Off/On Switch** \$17.95
Legs raise printer to allow fanfold paper underneath. Activator moves control of off/on switch to front of printer. No electrical modifications required.
- Front Off/On Switch Only \$10.95
- Expansion Module #2 with Turbo Cartridge** \$49
Includes a tabletop console with arcade-style steering wheel and floor operated accelerator foot pedal.
- Super Action Controllers (2) with Baseball Cartridge** \$59
- Roller Controller with Slither Cartridge** \$49
- Coleco Replacement Controller (single)** \$ 6
- WICO Command Control-Joystick/Keypad** \$12
Arcade size joystick delivers true arcade action and feel.
- Super Sketch by Personal Peripherals** \$32
Provides a totally unique and simple medium for creating super video graphics. As the stylus is moved across the Controller Pad, an image is created on your video monitor or TV. Four push buttons at the top of the pad control color selection and graphic functions of the stylus. Included along with the Controller Pad is a SKETCH MASTER plug in software cartridge that is compatible with the ADAM or ColecoVision.
- EVE SP-1 Serial/Parallel Interface Unit** Specify Serial/or Parallel (Disk, DP) \$139.95
The SP-1 includes an RS-232c Serial channel, and a (Centronics) Parallel printer channel. The SP-1 allows the use of hundreds of different printers both high speed dot matrix, and letter quality. With the SP-1 you can use standard modems, and direct connect to other computer systems. The SP-1 comes with software for use with SmartBasic and CP/M. The SmartBasic program allows the selective output to either the serial port, the parallel port, or the ADAM printer. A program is also provided to allow draft printout of a SmartWriter file to either the serial or parallel port. The CP/M programs allow the "IOBYTE" in CP/M to be set for the desired output.
- EVE SS-CC Speech Synthesizer Unit/Clock Calendar** (Disk, DP) \$109.95
Now you can give ADAM a 'VOICE.' The EVE speech unit may be used with your programs to add capabilities to your ADAM that are only limited by your imagination. Also on this interface unit is a 'real time' clock calendar circuit so you, and ADAM will now have an access to the time and date as needed. Software included includes a standard phoneme library, and a 'Clock/Alarm program. For use with SmartBasic and CP/M.
- EVE PS-1 Power Pack to Replace ADAM Printer Supply** \$69.95
The EVE PS-1 Power Pack is a replacement unit for the power supply in the standard printer. It allows the use of ADAM without the ADAM printer. It also provides power for the EVE line of interface products.



ACCESSORIES

PAPER PRODUCTS by REDIFORM (Tractor-feed fan-fold)

White Clean Edge 9½x11, 20 lb. sheet—1000 sheets/pack	\$21
White Clean Edge 9½x11, 20 lb. sheet—3000 sheets/pack	\$50
White Clean Edge Classic Bonded 9½x11 150 sheets/pack	\$ 7
Ivory Classic Clean Edge 9½x11 150 sheets/pack	\$ 7
½" Greenbar 9½x11, 18 lb. sheet—1000 sheets/carton	\$14
½" Greenbar 9½x11, 18 lb. sheet—3000 sheets/carton	\$33
White Envelopes, 20 lb. sheet—100 envelopes/pack	\$18
Ivory Envelopes, 20 lb. sheet—100 envelopes/pack	\$18
Continuous Self Adhesive Labels for Mailing, 3½ by 1, 1000 labels	\$ 7

DISKETTES

MAXELL 5¼ SS/DD Diskettes 10 pack	\$14
MEMOREX 5¼ SS/DD Diskettes 10 pack with library case	\$16
NASHUA 5¼ 5¼ SS/DD Diskettes 10 pack	\$11

MONITORS

SAKATA SG-1000 Green Monochrome	\$ 99
SAKATA SA-1000 Amber Monochrome	\$ 99
SAKATA SC-100 13" Composite Color Resolution	\$175
SAMSUNG 14" Color Composite	\$185
Thomson 12" Green with sound	\$125
Tilt Swivel Stand for Sakata SC-100	\$ 18

COMPUTER SUPPLIES FOR THE ADAM

Printer Ribbon for ADAM	Each \$5.50	3/\$15
Loran Digital Data Pack	Each \$5.50	5/\$25 10/\$39
(LORAN IS THE MAKER OF COLECO'S DATA PACKS),		
Dust Cover for ADAM — Vinyl brown 3 piece—CPU, KYBD, PRT		\$18.50
Dust Cover for ADAM Disk Drive — vinyl brown matches above set		\$ 8.95
ALPHA-ONE LTD ADAM Accessory Kit		\$32.00
(4 different daisy wheels—Pica 10, Courier 72, Courier 10, Emphasis, 2 Loran Data Packs, 1 Printer Ribbon, & 10 Tape Head & Disk Cleaner Pads).		
ADAM Monitor Cable — wired for ADAM to produce VIDEO/AUDIO		\$ 9.50
Disk Storage MM5 holds up to 50 5¼ Disks		\$11.00
Disk Storage — holds up to 10 5¼ Disks		\$ 4.00
Plain Label Compatible Pre-Formatted Blank Digital Data Packs		\$ 3.50
	TEN OR MORE EACH	\$ 2.90
SmartBASIC Replacement Data Pack		\$22.00
Daisy Wheels—Pica 10, Courier 10, Emphasis, Courier 72	EACH	\$ 5.50
CompuServe Starter Kit for your MODEM		\$24.00

TO BE INCLUDED ON OUR MAILING LIST SEND A SELF-ADDRESSED STAMPED BUSINESS SIZE ENVELOPE TO THE ABOVE ADDRESS. — THANK YOU —

ORDERING & TERMS:

Send cashier's check, money order, personal or company check. All orders shipped within the continental USA add \$2.50 per order shipping charges. APO, FPO, ALASKA, HAWAII, PUERTO RICO, & CANADA add 5% of total order (MINIMUM \$4.50) for shipping charges. NY State residents must add sales tax. C.O.D. orders phone 718-336-7612. Orders shipped in 72 hours if item is in stock. Canadian orders must be in a Postal Money Order in US currency. Price/Availability subject to change.

All sales are final, but we will readily accept and replace with the same item any products purchased from us that prove to be defective.

WE WILL NOT BE UNDERSOLD. WE WILL MEET OR BEAT ALL ADVERTISED PRICES FOR ANY ITEM THAT WE CARRY. JUST INCLUDE A COPY OF THE AD WITH YOUR ORDER.

ADAM™

HARDWARE/SOFTWARE



IN HOUSE SERVICE REPS.

*DISCOUNT HARDWARE & SOFTWARE FOR ADAM
HERE IS JUST A FEW ITEMS WE CARRY FOR ADAM...*

SOFTWARE IN COMPLETE ORIGINAL PACKAGING:

SMART LOGO/SMART LETTERS & FORMS/SMART FILER/EXPERTPE/ RECIPE FILER/
ELECTRONIC FLASHCARD MAKER/WACKY WORD GAMES/FLASHFACTS VOCABULATOR/
FLASHFACTS TRIVIA/SMART LETTERS & FORMS DISK/EXPERTPE DISK/RECIPE FILER
DISK/TELLY TURTLE/FORTUNE BUILDER/CABBAGE PATCH PICTURE SHOW/DONKEY KONG
DDP/DONKEY KONG JR. DDP/ AND MORE...

ORIGINAL PROGRAMS, STILL WRAPPED, WITH MANUALS & REGISTRATION CARDS. COMPLETE EXCEPT FOR ORIGINAL BOXES:

ADAM CALC/Dragons Lair S.G.P./ZAXXON S.G.P./EXPERTPE/FLASH CARD MAKER/
RECIPE FILER/SMART FILER/THE ADAM HOME SOFTWARE LIBRARY/ & MORE

CARTRIDGES:

SPACE FURY/BURGERTIME/COSMIC AVENGER/ BUMP 'N' JUMP/CARNIVAL/OMEGA
RACE/DESTRUCTOR/TIME PILOT/GORF/LADYBUG/ZAXXON/SMURF RESCUE/VICTORY
DONKEY KHONG JR/LOOPING/VENTURE/MOUSE TRAP/STAR TREK/ROCKY/FRENZY/BUCK
ROGERS/WAR GAMES/TARZAN/ROCK 'N' ROPE/SUBROCK/DUKES OF HAZZARD/& MORE

ADAM HARDWARE AND ACCESSORIES:

ADAM DISK DRIVES/ADAMLINK MODEMS/64K MEMORY EXPANDERS/MONITOR CABLE/
DATA DRIVES (NEW STYLE)/SPEECH SYNTHESIZER/IBM PC EMULATOR/PARALLEL
PRINTER INTERFACE/ & MORE

SEND SELF-ADDRESSED STAMPED ENVELOPE FOR THE LATEST LIST OF
PRICES....OR GIVE US A CALL AT (201) 867-7038 (ASK FOR DON)

IN HOUSE SERVICE REPS

DON PEARLMAN
620 HARMON COVE TWRG
SECAUCUS, NJ 07094

DATA DOCTOR

YOUR LOGICAL CHOICE
-for ADAM software-

Some of our standard software features are:

- * Multi-color screens
- * Full use of the sound chip
- * Super-fast LOADING (even on DDPs)
- * Full-length programs
- * SmartKEY referencing
- * Graphics displays/sprite animation
- * Input control-keyclick, bckspc to erase, etc
- * True randomization for games
- * User-friendly operation
- * Menu-driven programs
- * Menu-driven software packages
- * 30-day unconditional money-back guarantee
- * Detailed instruction manuals
- * Disk and datapack versions
- * Fast delivery (most shipped within 48 hrs)
- * FREE shipping and handling
- * Hacker challenge to infiltrate our LIST protection
- * And a 5-year limited warranty on all storage media.

- YOUR SATISFACTION IS OUR #1 GOAL -

EDITOR'S NOTE: SINCE PLACEMENT OF THIS AD WAS MADE, THE DATA DOCTOR HAS CEASED TO DO BUSINESS, HOWEVER, THERE LINE OF PRODUCTS ARE AVAILABLE THROUGH DIGITAL EXPRESS. (ALL INQUIRIES SHOULD BE MADE TO THEM-ADDRESS LISTED IN THE RETALER'S SECTION)

**FEEDBACK!
FEEDBACK!
FEEDBACK!
FEEDBACK!**

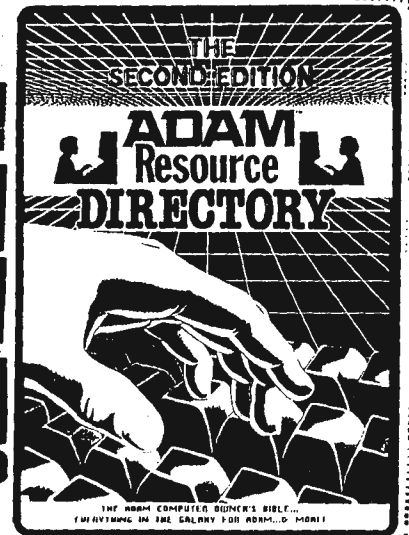

**PLEASE FILL-OUT THE INFORMATION ON BOTH
SIDES OF THIS SHEET. CAREFULLY REMOVE FROM
YOUR DIRECTORY, & MAIL TO THE ADAM
RESOURCE, (UPDATE DEPARTMENT) ALONG WITH
3- SELF-ADDRESSED STAMPED-ENVELOPES & WE
WILL PROVIDE YOU WITH FUTURE UPDATES TO
THIS DIRECTORY.(SEE PAGE 3 FOR DETAILS)
THANK YOU FOR YOUR FEEDBACK!!!!**

NAME _____

ADDRESS _____

CITY _____

STATE _____ ZIP _____

PHONE (_____) _____

ANSWER THESE ABOUT THIS DIRECTORY...

1. WHICH SECTION INTERESTS YOU THE MOST?

**2.ON A SCALE OF 1 TO 10 (10 BEING THE BEST)
HOW DO YOU RATE THIS DIRECTORY FOR ITS
OVERALL CONTENT?** _____

**3. WOULD YOU RECOMMEND THIS DIRECTORY TO A
FRIEND? _____ (IF YES, PLEASE DO SO!)**

**4. WHAT NEW SECTIONS WOULD BE BENEFICIAL TO
YOU AS A USER (IN FUTURE EDITIONS) ?**

**5. WHAT TYPE OF SOFTWARE OR HARDWARE WOULD
YOU LIKE TO SEE DEVELOPED FOR ADAM?**

(COMPLETE OTHER SIDE OF THIS SHEET PLEASE!)

**PLEASE USE THIS SHEET TO INFORM THE ADAM RESOURCE OF ANY ADDITIONS, CORRECTIONS, SUGGESTIONS, TIPS, ETC.. THAT YOU THINK WE SHOULD KNOW FOR FUTURE REFERENCE. WE INVITE YOUR PARTICIPATION IN MAKING THIS ONE OF THE MOST COMPLETE SOURCES OF ADAM INFORMATION AVAILABLE. IF YOU'VE DISCOVERED SOMETHING EXCITING ABOUT ADAM, LET US KNOW & WE'LL HELP PASS THE INFO ALONG.
(PLEASE PRINT OR WRITE CLEARLY)**

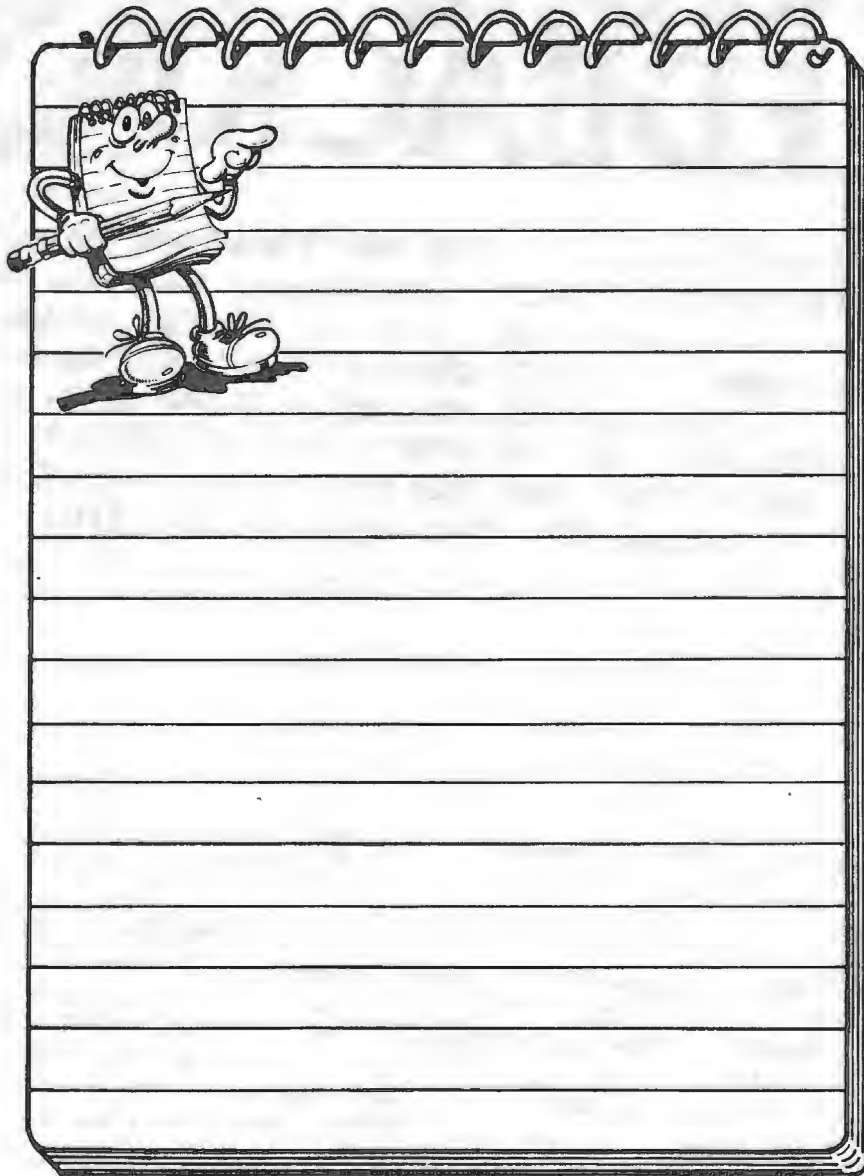

THE ADAM RESOURCE CURRENTLY PLANS TO PUBLISH THIS DIRECTORY AS THE MARKET, INTEREST, AND DEMAND FOR THE ADAM COMPUTER CONTINUES. IN OTHER WORDS, AS LONG AS YOU SUPPORT US... WE'LL SUPPORT YOU. (THIS IS AN ANNUAL PUBLICATION)

SECOND
the **EDITION**
ADAMTM
Resource
DIRECTORY

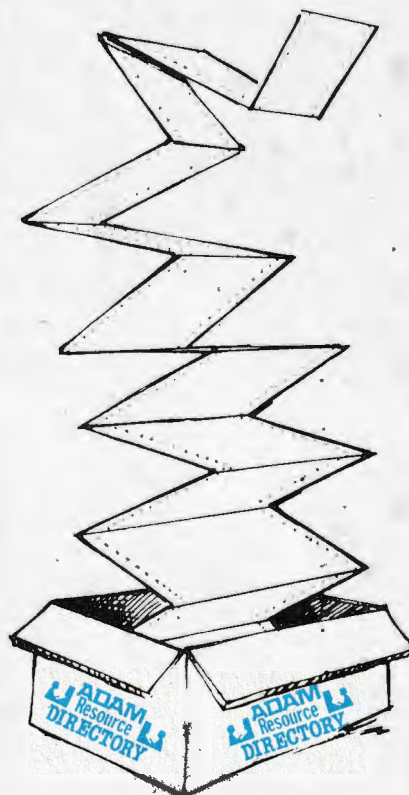

In This Edition You Will Find

- Software Listings**
- Hardware Listings**
- ADAM Publications**
- User Groups**
- Users**
- Service & Care Info**
- Online Info**
- General Tips**
- ADAM-Hacker Info**
- Technical Info**
- Making Your Own ADAM**
- The ADAM Shopper**
- ADAM Retailers**
- ADAM Mail-order Companies**
- ADAM Updates...**
- ...& So Much More!!!**

The Adam Resource
P.O. Box 90
Seelyville, In. 47878